

**IZELTAS®** 55.yil

OCAK 2023 FİYAT KATALOĞU

OCAK 2023 FİYAT KATALOĞU

**2023**

**IZELTAS®**

**100**

MİLLİ MÜCADELE'NİN YÜZÜNCÜ YILI

**YERLİ  
ÜRETİM**

# İZELTAŞ UYGULAMASI, APP STORE VE GOOGLE PLAY'DE!

Katalogdan bayilere, video içeriklerinden şikayet ve geri bildirimlerine kadar birçok alana ulaşılabilirliği kolaylaştıran app uygulamamız yayında.

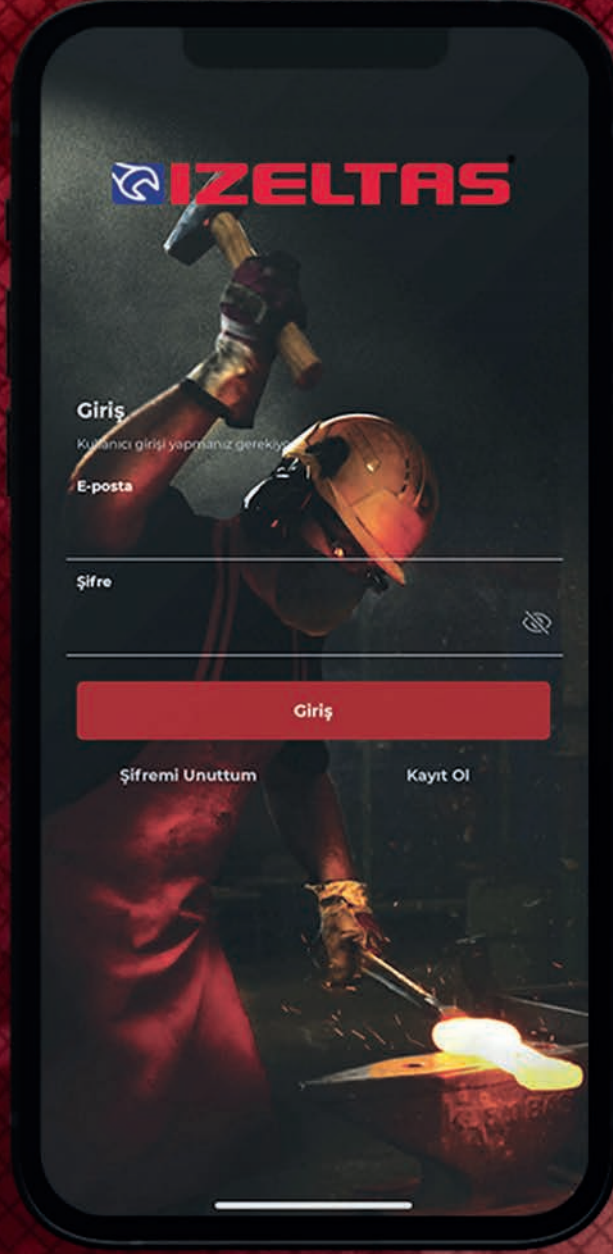

IOS ve Android uyumlu ücretsiz uygulamamızı hemen indirin,  
**İzeltaş cebiniz kadar yakınınızda olsun!**

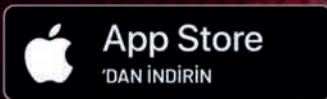

## GARANTİ ŞARTLARI / WARRANTY CONDITIONS

### A-KAPSAM İÇİ

1. Normal kullanım şartlarına uygun kullanılan ancak, imalat veya malzeme hatası tespit edilen ürünler, ömür boyu garanti kapsamında, tamir edilir veya mümkün değilse, derhal yenisi ile değiştirilir.

### B-KAPSAM DIŞI

Aşağıda yazılı şartlarda kullanılan aletler, garanti kapsamı dışında olup, yenisi ile değiştirilmezler.

1. Kullanım amacı veya kullanma talimatı dışında kullanılmış olan ürünler.
2. Aşırı zorlama ile, boru takılarak veya çekiçle vurularak darbeli kullanım sonucu deforme olmuş ya da kırılmış olan ürünler.
3. Kullanıcı tarafından üzerinde taşlama, zımparalama, delme veya kaynak yapılarak orijinal hali bozulmuş olan ürünler.
4. Kullanıldıktan sonra, gerekli koruyucu bakımları yapılmadan, tozlu, rutubetli ve çamurlu ortamlarda bekletilerek fonksiyonu kaybolmuş ürünler.
5. Uygun olmayan rutubetli ortamlarda, uzun süre stoklanarak, paslanmış, korozyona uğramış olanlar.
6. Uzun süre kullanılmış veya kullanım ömrünü tamamlamış, buna bağlı olarak eskimiş, yıpranmış, deforme olmuş ürünler.



### EMNİYETLİ VE DOĞRU EL ALETİ KULLANIM KURALLARI

#### A-UYULMASI GEREKEN KURALLAR:

1. Anahtarın ölçüsünün kullandığınız parçaya göre uygun olduğundan emin olunuz.
2. Kullanım esnasında aletin doğru şekilde yerleştirildiğinden emin olunuz.
3. Aleti sık kontrol ediniz. Aşınmış, zarar görmüş aletleri değiştiriniz.
4. Aleti kullanım şartlarına uygun olarak kullanınız, aşırı yük uygulamayınız.
5. Özellikle çekiçlerde vurma yüzeyinin, vurulan yüzeyden daha büyük olmak zorunda olduğuna dikkat ediniz.
6. Havalı aletlerde daima uygun aksesuarı kullanınız. (Ayrıca basınçlı havanın yağlandığından emin olunuz.)
7. Çalışma şartlarına göre uygun kişisel koruma teçhizatı kullanınız.
8. Tekerlekli takım dolaplarını, daima kapılarını ve hareketli bölümlerini kilitledikten sonra hareket ettiriniz.
9. Tekerlekli takım dolabı üzerinde çalışırken, tekerleklerini frenleyiniz.
10. Yüksek gerilimli çalışma ortamlarında TS EN IEC 60900 Standartına uygun olarak üretilmiş VDE belgeli ürünleri kullanınız.
11. Aletlerin nemli ve ıslak ortamlarda kullanımını ardından mutlaka kurutunuz ve hafif yağlayınız.

#### B-YAPILMAMASI GEREKEN İŞLEMLER:

1. Boru vb. uzatmalar kullanılarak olması gereken tork gücünü aşmayınız. (Özellikle tüm anahtarlarda)
2. Hiçbir aleti üretim maksadına aykırı işlerde kullanmayınız. (örneğin: tornavidanın levye veya keski gibi kullanımı)
3. Aşırı güç uygulayarak (boru takarak veya çekiçle vurarak) aleti zorlamayınız. (örneğin: anahtarlar ve tornavidalar)
4. Hiçbir zaman, kullandığımız aleti kendinden daha sert olan bir cisme vurmeyiniz. (örneğin: çekiç ve keski)
5. Aletleri değişikliğe uğratmayınız. (Şekli veya bir kısmını)
6. Metrik ölçülü anahtarları, inch ölçülü civatalarda kullanmayız veya tersini yapmayınız.
7. Yıpranmış ve hatalı aletleri kullanmayınız.
8. Tekerlekli tamir dolabı dolu iken, birden fazla çekmeceyi açık tutmayınız, çekmeceler açıkken hareket ettirmeyiniz.
9. Aletin fonksiyonunu iyileştirmek maksadı ile üzerinde zımpara, taş, kaynak vb. işlem yapmayınız.
10. Aletin kullanımını sırasında boya veya kaplamanın çıkacağı etkilere maruz bırakmayınız. Aksi halde korozyon dayanımı negatif etkilenecektir.
11. İzolasyonu zedelenmiş, sapı yıpranmış VDE sertifikalı ürünleri hiçbir şekilde yüksek gerilim ihtiva eden ortamlarda kullanmayınız.
12. Kontrol kaleminin iç mekanizmasını kesinlikle sökmeye çalışmayınız. Kontrol kalemleri 110 – 250 VAC çalışma aralığı için uygundur.
13. Yukarıda bahsedilen şartlara ve doğru kullanıma riayet ederek, her zaman amaca yönelik uygun aletleri kullanınız.

#### A- INCLUDED CASES

1. Products used in accord with normal use conditions but found to have production or material errors will be repaired or if this is not possible replaced immediately under lifetime warranty.

#### B- EXCLUDED CASES

Products used under any of the conditions listed below are excluded from the warranty scope and cannot be replaced with new ones:

1. Products used outside the intended purpose or instructions of use;
2. Products deformed or broken due to excessive forcing, pipe attachment or hammer impact;
3. Products whose original form is altered by the user by stoning, grinding, perforation or welding;
4. Products which lost their function due to being left in dusty, moist or muddy environments without necessary protective maintenance after use;
5. Products which became rusted or corroded due to being stored in unsuitable, moist environments for extended periods of time;
6. Products which are used for a long period of time or which have completed their useful life and accordingly have become old, worn out and deformed.

#### RULES FOR SAFE AND CORRECT USE OF HAND TOOL

##### A- PRACTICAL RULES:

1. Make sure size of the wrench is appropriate for the work piece.
2. Make sure the tool is positioned correctly during use.
3. Frequently control the tool. Replace worn or damaged tools.
4. Use the tool in accord with instructions of use. Do not place too much load on the tool.
5. Especially beware of the point that the impact surface of a hammer must be larger than the impacted surface.
6. Always use appropriate accessories for pneumatic tools. (Also make sure the pneumatic system is properly lubricated.)
7. Use personal protection equipment appropriate for work conditions.
8. Always make sure to lock lids and moving parts of wheeled set cabinets before moving them.
9. Make sure to lock brakes of the wheeled set cabinets before working on them.
10. Use VDE certified products made in accord with TS EN IEC 60900 Standard in high voltage work environments.
11. Make sure to dry and lightly lubricate tools after use in moist and wet environments.

##### B- ACTIONS TO AVOID:

1. In case of use with extensions like pipes, etc. do not exceed the specified torque value (especially in case of all wrenches).
2. Do not use any tool outside of its intended purpose (e.g. do not use a screwdriver as a lever or a chisel).
3. To not force the tool (e.g. wrenches and screwdrivers) by using excessive force (by pipe attachment or hammer impact).
4. Never use the tool to hit another object harder than the tool (e.g. hammer and chisels).
5. Do not alter the tools (in form or partially).
6. Do not use metric sized wrenches on inch sized bolts or vice-versa.
7. Do not use worn out or faulty tools.
8. Do not leave multiple drawers open when using the wheeled set cabinet and do not move the cabinet while the drawers are open.
9. Do not perform grinding, stoning, welding, etc. on the tool in order to improve its function.
10. Do not expose the tool to conditions that might result in loss of paint or coating during use. Otherwise corrosion resistance of the tool will be affected.
11. Never use VDE certified products with damaged or worn isolation or handle in high voltage work environments.
12. Never attempt to dismantle the internal assembly of the tester. Testers are suitable for use in the 110 – 250 VAC operation range.
13. Always use the right tool for the right job and follow the conditions and rules of correct usage detailed above.

## **Yarım asırlık 'güven'**

### **Kalite yolculuğu inanmakla başlar.**

Türkiye'nin ilk ve en büyük el aletleri üreticisi İZELTAŞ, 1968 yılında Ege'nin gözbebeği İzmir'den işte bu inançla yola çıktı. Yüzde 100 Türk sermayesiyle oluşturulan ve günden güne büyüyen İZELTAŞ, modern teknolojiyle donatılmış dev tesislerinde üretilen dört bin beş yüz den fazla ürünle 40 ülkeye ihracat yaparak hem kendi insanına hem de ülke ekonomisine katkı sağlıyor.

El aletlerinin yanı sıra üretilen dövme parçalar ile başta otomotiv olmak üzere inşaat, denizcilik ve madencilik sektörüne, savunma ve havacılık sanayilerine, ziraat endüstrisine, altyapı işlerine dek birçok kamu ve özel sektör kuruluşuna hizmet sunuyor.

### **Daha iyisi, daha yenisi için...**

Kalıphane, dövme, işleme, ısıl işlem, krom-nikel kaplama, boyama, plastik daldırma, plastik enjeksiyon ve markalama departmanlarından oluşan dünyadaki ender entegre fabrikalardan İZELTAŞ'ta üretimin her aşamasında kalite kontrolüne tabi tutulan ürünler; fiziksel, metalürjik, kimyasal ve elektriksel testlerden geçirilerek İZELTAŞ güvencesine alınıyor. Ar-Ge ve inovasyon ışığında değişime ve gelişime her daim açık olan İZELTAŞ, bu sayede gücüne güç katıyor.

T.C. Sanayi ve Teknoloji Bakanlığında AR-GE Merkezi belgesine sahip İZELTAŞ, TS EN ISO 9001 Kalite Yönetim Sistemi, ISO/IEC 27001 Bilgi Güvenliği Yönetim Sistemi, TS (OHSAS) 18001 İş Sağlığı ve Güvenliği Yönetim Sistemi, TS EN ISO 14001 Çevre Yönetim Sistemi, TS EN ISO 50001 Enerji Yönetim Sistemleri; TSE, TSEK, VDE GS ürün kalite belgeleri ve yüksek teknolojisi ile sadece Türkiye'de değil, dünyada da farkını ortaya koyuyor.

### **Önce güvenlik, sonra üretim**

İnsan önemli, emek değerlidir. İZELTAŞ, "Önce güvenlik" anlayışından ayrılmadan, çalışanları için önlem almaya, onları iş sağlığı ve güvenliği konusunda eğitmeye devam ediyor. Çünkü; "İnsan vücudunun yedek parçası yoktur"

### **Size ulaştıktan sonra...**

Satış sonrasında tüketici haklarını koruma ve sınırsız hizmet anlayışı İZELTAŞ'ın vazgeçilmez şirket politikalarından birini oluşturuyor.

Dolayısıyla...

- El aletleri' dendiğinde akla gelen ilk isim olabildiysek,
- Yarım asırdır 'aileden biri' olmanın hakkını verebildiysek,
- 'Türk malı' sözünün altına imzamızı atabildiysek,
- 'Yıllarca kullanılır' diyerek her zaman tercih edildiysek,

Gücümüzü, şevkimizi ve inancımızı siz değerli bayilerimiz ve tüketicilerimizden alıyoruz.

850 çalışanımızla birlikte üreterek, değer sağlayarak dünya markası olmanın haklı gururunu yaşıyoruz.

Nice başarılı yıllara!

## **Half a century of reliability**

### **Faith is the essential step on the journey to achieve utmost quality.**

As the first and largest hand tool manufacturer of Turkey, İZELTAŞ, had this faith as it started its journey in 1968 in Izmir, the beautiful city in the Aegean region. Its establishment, consisting of 100% national capital, İZELTAŞ has grown in years into an industrial giant with huge facilities equipped with state-of-the-art technologies and over 4500 products. Exporting to more than 40 countries, the company is a prominent contributor to not only the Turkish economy but also the community.

Along with manufacturing hand tools, İZELTAŞ produces forged steel parts for various industries like automotive, construction, maritime, mining, aviation, defence, agriculture and infrastructure.

### **Newer and better**

İZELTAŞ is one of the few fully integrated factories in the world that consists of die tooling, forging, processing, heat processing, chrome-nickel plating, dyeing, pvc coating, plastic injection and marking departments. Every stage of the production is tested for quality assurance using physical, metallurgical, chemical and electrical methods. R&D and innovation are the key words that empower İZELTAŞ as a company which embraces development and improvement as its main philosophy.

İZELTAŞ is an accredited R&D Center by the Ministry of Science, Industry and Technology and has been certified with the following: ISO 9001 Quality Management System, ISO/IEC 27001 Informationsecurity Management System, OHSAS 18001 Occupational Health and Safety Management System, ISO 14001 Environment Management System, ISO 50001 Energy Management System certification, TSE, TSEK and VDE GS product certification.

### **Safety before production**

Humans are the most significant factors of any industry and their labour is precious. Health and safety awareness is the fundamental policy of İZELTAŞ. The company continuously organizes training programs on occupational health and safety which emphasise that safety comes first and it is not possible to fix humans by changing the damaged organs with spare ones.

### **Customer satisfaction**

Another fundamental policy of İZELTAŞ is the customer satisfaction. The company is dedicated to serve its customers and protect their rights as consumers.

Hence...

- We are the first brand that comes to mind in the hand tools industry
- We are valued almost as a part of the families of our consumer
- We have proved ourselves worthy of the statement "Made in Turkey"
- We have been the first choice of the consumers for durability over the years

Our power, enthusiasm and faith are derived from our distinguished dealers and consumers.

We are proud to have become a world brand with our 850 employees who strive everyday to contribute to the productivity of the company, creating an added value for the economy and our community.

To many successful years to come!

**Takım Dolapları ve Takım Çantaları**  
Tool Trolleys, Tool Boxes



5-45

**Anahtarlar**  
Wrenches



46-68

**Lokma ve Bijon Anahtarları**  
Sockets and Rim Wrenches



69 -98

**Boru Anahtarları ve Penseler**  
Pipe Wrenches and Pliers



99-118

**1000V Grubu Ürünler**  
1000V Product Group



119-127

**Tornavida ve Allen Anahtarlar**  
Screwdrivers and Hex Key Wrenches



128-152

**Keskiler ve Çekiçler**  
Chisels and Hammers



153-160

**Genel El Aletleri**  
General Hand Tools



161-172

**Makaslar**  
Shears



173-180

**Çektirmeler**  
Pullers



181-187



188-200

**Yedek Parçalar**  
Spare Parts



201-205

**Ticari Teşhir Standları**  
Commercial Display Stands



206-210

**Teknik Bilgiler ve İndeks**  
Technical Information and Index



211-



*"Sadece el aleti üretmiyoruz;  
el aletleriyle her şeyi üretiyoruz."*

*"We don't just produce hand tools;  
we build everything with hand tools."*

**İZELTAS®**

# TAKIM DOLAPLARI TAKIM ÇANTALARI VE ALET SETLERİ

TOOL TROLLEYS, TOOL BOXES AND  
HAND TOOL SETS



Takım Dolapları  
Tool Cabinets

Takım Çantaları  
Tool Boxes

Servis Masaları  
Service Tables

Alet Setleri  
Tool Sets



İZELTAS YOUTUBE





## 8245 PREMIUM SERİSİ / PREMIUM SERIES

Premium Serisi Takım Dolabı ( 5-7 Çekmeceli )  
Premium Series Workshop Trolley ( 5-7 Drawers )



✓ 6 bölmeli sağlam ve dayanıklı ABS plastik üst malzeme tabla.  
● Resistant and solid top cover having 6 divisions

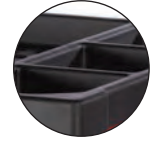

✓ %100 açılabilir teleskobik raylar.  
● %100 extendable telescopic slides



✓ Merkezi kilit  
✓ Mandal sistemi  
✓ Devrilme emniyet sistemi  
● Central lock  
● Handgrip Lock system  
● Anti tilt system



✓ 2 sabit, 2 hareketli frenli tekerlek ø 125mm  
● 2 swivel castors with brake  
2 fixed castors ø 125mm



✓ Standard tutma sapı  
● Standard handle



✓ Plastik köşe koruma  
● Plastic corner protection



✓ Yüksek dayanımlı elektrostatik toz boya.  
● High strength electrostatic powder coating.



✓ Havluluk x1  
Avadanlık x2 Askılık x1  
● Paper Roll Holder  
x 1 Bottle & Tins Holder x2 Hanger x1

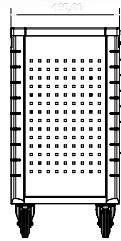
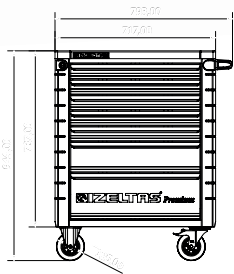

Ölçü/Size: 485x717x944 mm

Sacdan imal edilmiş, Fırın boya  
Made of sheet metal, Electrostatic paint



İZELTAS YOUTUBE

KOD/CODE	ÇEKMECE DRAWERS	35 kg	35 kg	35 kg	Kg	RENK COLORS	FİYAT TL/Ad
		400x548x63	400x548x132	400x548x202			
8245 32 1005	5	2X	1X	2X	64		10.384,50
8245 32 1007	7	5X	1X	1X	70	RAL 9005 RAL 3020	13.443,50
8245 00 7096 Dolu/Full 243 Parça/Pcs	7	5X	1X	1X			37.213,50



### 1. Premium Seri Çekmece/Drawer Kod / Code 8245001042

KOD CODE	İÇERİK CONTENTS	□	FİYAT TL/Ad
0100	<b>İki Ağız Anahtar Kısa Boy</b> D/E Open jaw wrenches Short Pattern 6x7-8x9-10x11-12x13-14x15-16x17-18x19-20x22	8	4.527,50
0320	<b>Kombine Anahtar Kısa Boy</b> Combination wrenches Short Pattern 6-7-8-9-10-11-12-13-14-15-16-17-18-19-20-21-22-24-27-30-32	21	
0430	<b>Yıldız Anahtar</b> Ring Wrenches 6x7-8x9-10x11-12x13-14x15-16x17-18x19-20x22	8	
0340	<b>Cırcır Kombine Anahtar / Combination Wrench With Ratchet</b> 8-10-13-17-19	5	

### 2. Premium Seri Çekmece/Drawer Kod / Code 8245002094

KOD CODE	İÇERİK CONTENTS	□	FİYAT TL/Ad
1107	<b>1/4" Lokmalı Allen Uçlar / Hexagonal Bits Socket</b> 2,5-3-4-5-6-7-8-10	8	5.017,00
1107	<b>1/4" Lokmalı Torx Uç / Torx Bits Socket</b> T8-T9-T10-T15-T20-T25-T27-T30-T40	9	
1107	<b>1/4" Lokmalı Yıldız Uç / Phillips Bits Socket</b> PH1-PH2-PH3	3	
1107	<b>1/4" Lokmalı Düz Uç / Slotted Bits Socket</b> 3-4-5,5-6,5	4	
1107	<b>1/4" Altı Köşe Derin Lokma / Deep Socket Wrench 6 Point</b> 4-5-5,5-6-7-8-9-10-11-12-13	11	
1113	<b>1/2" Lokmalı Allen Uç / Hexagonal Bits Socket</b> 5-6-7-8-10-12-14	7	
1113	<b>1/2" Lokmalı Torx Uç / Torx Bits Socket</b> T20-T25-T27-T30-T40-T45-T50-T55-T60	9	
1107	4 - 5 - 6 7 - 8 - 9 - 10 11 - 12 - 13 <b>Altı Köşe</b> Six Points <b>1/4" Altı Köşe Lokma Takımı / Socket Wrench Set</b> <b>1/4" Cırcır kolu / Ratchet Handle</b> <b>1/4" Mafsal / Universal Joint</b> <b>1/4" T Kol / Sliding T Handle</b>	15	
1113	<b>1/4" Ara Kol / Extention Bar 50-100 mm</b> <b>1/2" Buji Lokma Lastikli</b> Spark Plug Socket With Rubber 16 mm	1	
1113	10 - 11 - 12 - 13 14 - 15 - 16 - 17 18 - 19 - 21 - 22 23 - 24 - 26 - 27 28 - 30 - 32 <b>Altı Köşe</b> Six Points <b>1/2" Lokma Takımı / Socket Wrench Set</b> <b>1/2" Cırcır Kolu 32 Diş / Ratchet Handle</b> <b>1/2" Mafsal / Universal Joint</b> <b>1/2" T Kol Adaptör / Sliding T Handle Adapter</b> <b>1/2" Ara Kol / Extension Bar 125-250 mm</b>	24	

### 3. Premium Seri Çekmece/Drawer Kod / Code 8245003014

KOD CODE	İÇERİK CONTENTS	□	FİYAT TL/Ad
3700	<b>Yan Keski Opak Seri / Side Cutting Pliers 160 mm</b>	1	2.340,75
3020	<b>Kombine Pense Opak Seri / Combination Pliers 180 mm</b>	1	
3220	<b>Kargaburun Düz Uçlu Opak Seri / Nose Pliers Flat 180 mm</b>	1	
4300	<b>Opak Seri Düz Uçlu Tornavida / Screwdriver, Flat</b> 3x80-5x125-7x150	3	
4320	<b>Opak Seri Yıldız Uçlu Tornavida / Screwdriver, Phillips</b> 3x60-4.5x80-6x100-8x150	4	
3301	<b>Dış Segman Pensi Düz / Circlip Pliers, External Flat</b> 140-180mm	2	
3321	<b>İç Segman Pensi Düz / Circlip Pliers, Internal Flat</b> 140-180mm	2	

**4. Premium Seri Çekmece/Drawer** Kod / Code 8245004043

KOD CODE	İÇERİK CONTENTS	□	FİYAT TL/Ad
4770	<b>Lokma Uçlu Tornavida / Nutspinner</b> 6-7-8-9-10-13	6	2.670,00
4910	<b>Torx Allen Takım / Torx Key Wrench Set</b> T9-T10-T15-T20-T25-T27-T30-T40	8	
4900	<b>Allen Takımı 6 Köşe / Hex Key Wrench Set</b> 2-2.5-3-3.5-4-5-6-7-8-9-10-12	12	
4906	<b>Yuvarlak Başlı Uzun Allen Takımı / Hex key Wrench Ballpoint Long Pattern Set</b> 1.5-2-2.5-3-4-5-6-8-10	9	
4920	<b>T Tipi Allen Anahtar / T Type Hex Key Wrench</b> 2.5-3-4-5-6-7-8-10	8	

**5. Premium Seri Çekmece/Drawer** Kod / Code 8245005043

KOD CODE	İÇERİK CONTENTS	□	TL/Ad.
4565	<b>Oto Elektrik Kontrol Kalemi / Car Voltage Tester 135mm</b>	1	2.879,50
07415	<b>Sıralı Tel Fırça 4 Sıralı / Hand Brush 4 Raws</b>	1	
2400	<b>Üniversal Fort Pense / Waterpump Pliers Universal 240 mm</b>	1	
2500	<b>Üniversal Ayarlı Pense / Universal Grip 250 mm</b>	1	
0600	<b>Kurbağacık Anahtar / Adjustable Wrench 10"</b>	1	
4780	<b>Manyetik Bits Tutucu Tornavida / Screwdriver, Magnetic Bit Holder</b> 6.3x120	1	
4800	<b>31'li Bits Set (Plastik Kutulu) / Bits Set in plastic case</b>	31	
4110	<b>Düz Topaç Tornavida / Screwdriver, Stubby, Flat 6.5x25</b>	1	
4130	<b>Yıldız Topaç Tornavida / Screwdriver, Stubby, Phillips 6x25</b>	1	
5500	<b>Düz Keski Krom / Flat Cold Chisel 150 mm</b>	1	
5800	<b>Tesviyeci Çekici / Machinist's Hammer 300-1500 gr</b>	2	
6350	<b>Levye Oluklu / Tyre Lever 500 mm</b>	1	

**6. Premium Seri Çekmece/Drawer** Kod / Code 8245006009

KOD CODE	İÇERİK CONTENTS	□	FİYAT TL/Ad
1855	<b>Mafsallı T Kol Lokma</b> T- Handle Wrench with Universal Join 8-10-12-13-17-19	6	6.335,25
6230	<b>Gres Pompası</b> Grease Gun 500cc	1	
06375	<b>Ayarlı Yağ Filtre Sökeceği</b> Adjustable Slot Type Oil Filter Wrench	1	
6225	<b>Madeni Yağdanlık (Flexible Uçlu)</b> Oiler With Flexible Spout 200cc	1	



İZELTAS USTA İŞİ  
SOHBETLER



İZELTAS YOUTUBE

## 8241 PRO SERİSİ / PRO SERIES

Pro Serisi Takım Dolabı ( 5-6-7-8 Çekmeceli )  
 Pro Series Workshop Trolley ( 5-6-7-8 Drawers )



✓ Merkezi kilit sistemi, mandal sistemi ve devrilme emniyet sistemi.  
 ● Central lock system, handgrip lock system and antitilt system.



✓ Teleskobik rulmanlı kızaklar tüm çekmeceler %100 açılabilir.  
 ● Telescopic slides which are %100 extendable.



✓ 8 bölmeli sağlam ve dayanıklı ABS plastik üst malzeme tabla.  
 ● Durable ABS worktop with 8 divisions



✓ 2 sabit, 2 hareketli frenli tekerlek Ø 125mm  
 ● 2 swivel castors with brake, 2 fixed castors Ø 125mm



✓ Yüksek dayanımlı elektrostatik toz boya.  
 ● High strength electrostatic powder coating



✓ Toplam 6 Adet yan ve arka avadanlık bölümleri.  
 ● 6 tool holders



Ölçü/Size: 470x670x1007 mm

Sacdan imal edilmiş, Fırın boya  
 Made of sheet metal, Electrostatic paint

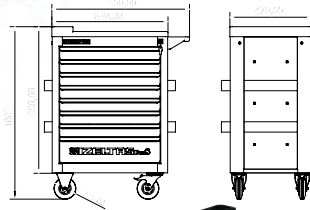

KOD/CODE	CEKMECE DRAWERS	35 kg	35 kg	35 kg	KG	RENK COLORS	FİYAT TL/Ad
8241 32 1005	5	1X	4X	--	59		10.737,00
8241 32 1006	6	4X	1X	1X	62	RAL 7035	11.602,25
8241 32 1007	7	5X	2X	--	65	RAL 3020	13.711,00
8241 32 1008	8	7X	1X	--	67		14.615,25
8241 32 2005	5	1X	4X	--	59		10.737,00
8241 32 2006	6	4X	1X	1X	62	RAL 7035	11.602,25
8241 32 2007	7	5X	2X	--	65	RAL 5003	13.711,00
8241 32 2008	8	7X	1X	--	67		14.615,25
8241 32 3005	5	1X	4X	--	59		10.737,00
8241 32 3006	6	4X	1X	1X	62	RAL 7035	11.602,25
8241 32 3007	7	5X	2X	--	65	RAL 7016	13.711,00
8241 32 3008	8	7X	1X	--	67		14.615,25
8241 00 1209 Dolu/Full 206 Parça/Pcs	8	7X	1X	--			32.219,75

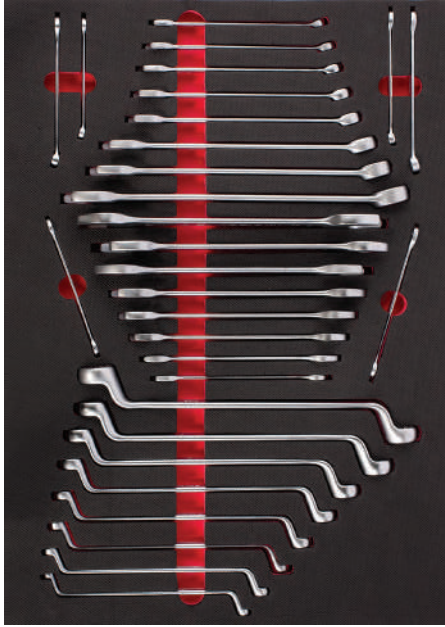

## 1. Pro Seri Çekmece/Drawer

Kod / Code 8241001030

KOD CODE	İÇERİK CONTENTS		FİYAT TL/Ad
0130	<b>İki Ağız Anahtar Uzun Boy / D/E Open Jaw Wrench Long Pattern</b> 6x7 - 8x9 - 10x11 - 12x13 14x15 - 16x17 - 18x19 - 20x22 21x23 - 24x26	10	
0330	<b>Kombine Anahtar Uzun Boy / Combination Wrench Long Pattern</b> 6 - 7 - 8 - 9 - 10 - 11 - 12 - 13 14 - 17 - 19 - 22	12	2.280,25
0430	<b>Yıldız Anahtar / D/E Ring Wrench</b> 6x7 - 8x9 - 10x11 - 12x13 14x15 - 16x17 18x19 - 20x22	8	



## 2. Pro Seri Çekmece/Drawer

Kod / Code 8241002072

KOD CODE	İÇERİK CONTENTS		FİYAT TL/Ad
1107	<b>1/4" Altı Köşe Lokma Takımı / 1/4" Socket Wrench Set</b> 4 - 5 - 6 7 - 8 - 9 - 10 11 - 12 - 13 <b>Altı Köşe Six Point</b>	15	
1113	<b>1/4" Cırcır kolu / 1/4" Ratchet Handle</b> <b>1/4" Mafsal / 1/4" Universal Joint</b> <b>1/4" T Kol / 1/4" Sliding T Handle</b> <b>1/4" Ara Kol / 1/4" Extension Bar 50-100 mm</b>		
1113	<b>1/2" Lokma Takımı / 1/2" Socket Wrench Set</b> 10 - 11 - 12 13 - 14 - 15 16 - 17 - 18 19 - 21 - 22 23 - 24 - 26 27 - 28 - 30 32	24	4.544,00
1113	<b>1/2" Cırcır Kolu 32 Diş / 1/2" Ratchet Handle</b> <b>1/2" Mafsal / 1/2" Universal Joint</b> <b>1/2" T Kol Adaptör / 1/2" Sliding T Handle Adapter</b> <b>1/2" Ara Kol / 1/2" Extension Bar 125-250 mm</b>		
1113	<b>1/2" Lokmalı Allen Uçlar / 1/2" Hexagonal Bits Sockets</b> H5-H6-H7-H8-H10-H12-H14	7	
1113	<b>1/2" Lokmalı Star Uç / 1/2" Star Bits Socket</b> T20-T25-T27-T30-T40-T45-T50-T55-T60	9	
0330	<b>Kombine Anahtar Uzun Boy / Combination Wrench Long 16-18</b>	2	
4900	<b>Allen Takımı 6 Köşe / Hex Key Wrench Set 2-2.5-3-3.5-4-5-6-7-8-9-10-12</b>	12	



## 3. Pro Seri Çekmece/Drawer

Kod / Code 8241003051

KOD CODE	İÇERİK CONTENTS		FİYAT TL/Ad
07415	<b>Sıralı Tel Fırça 3 Sıralı / Hand Brush 3 Rows</b>	1	
6350	<b>Levye Oluklu / Tyre Lever 400 mm</b>	1	
6220	<b>Spiralli Mıknatıs / Flexible Magnet Holder 500 gr</b>	1	
4110	<b>Düz Topaç Tornavida / Screwdriver , Stubby, Flat 6.5x25</b>	1	
4130	<b>Yıldız Topaç Tornavida / Screwdriver , Stubby, Phillips 6x25</b>	1	2.157,00
4770	<b>Lokma Uçlu Tornavida / Nutspinner 6-7-8-9-10-13</b>	6	
4780	<b>Manyetik Bits Tutucu Tornavida / Screwdriver, Magnetic Bit Holder 6.3x120</b>	1	
4905	<b>Yuvarlak Başlı Allen Takımı / Hexkey Wrench Ballpoint Set</b> 2-2.5-3-4-5-6-8-10	8	
4800	<b>Bits Set Takım (Plastik Kutulu) / Bits Set in Plastic Case</b>	31	



#### 4. Pro Seri Çekmece/Drawer

Kod / Code 8241004027

KOD CODE	İÇERİK CONTENTS	☐	FİYAT TL/Ad
0340	<b>Cırcır Kombine Anahtar</b> / Combination Wrench With Ratchet 10-13-17-19	4	3.757,25
4909	<b>T Tipi Torx Allen Anahtar</b> / Torx Allen Key T type T9-T10-T15-T20-T25-T27-T30-T40	8	
1108	<b>1/2" Altı Köşe Derin Lokma</b> / 1/2" Deep Socket Wrench, six points 10-11-12-13-14-15-16-17-18-19	10	
1113	<b>1/2" Altı Köşe Havalı Lokma</b> / 1/2" Impact Socket Wrench 13-17-18-19-24	5	



#### 5. Pro Seri Çekmece/Drawer

Kod / Code 8241005010

KOD CODE	İÇERİK CONTENTS	☐	FİYAT TL/Ad
3331	<b>İç Eğri Segman Pense</b> / Circlip Pliers, Internal, Bent 170 mm	1	3.112,75
3321	<b>İç Düz Segman Pense</b> / Circlip Pliers, Internal, Flat 180 mm	1	
3311	<b>Dış Eğri Segman Pense</b> / Circlip Pliers, External, Bent 170 mm	1	
3301	<b>Dış Düz Segman Pense</b> / Circlip Pliers, External, Flat 180 mm	1	
3700	<b>Yan Keski Opak İzole</b> / Side Cutting Pliers, 160 mm	1	
3220	<b>Düz Kargaburun Opak İzole</b> / Nose Pliers, 200 mm	1	
3020	<b>Kombine Pense Opak İzole</b> / Combination Pliers, 180 mm	1	
2510	<b>Ayarlı Pense</b> / Special Grip 250 mm	1	
0600	<b>Kurbağacık Anahtar</b> / Adjustable Jaw Wrench 10"	1	
2400	<b>Üniversal Fort Pense</b> / Waterpump Pliers Universal 240 mm	1	



#### 6. Pro Seri Çekmece/Drawer

Kod / Code 8241006018

KOD CODE	İÇERİK CONTENTS	☐	FİYAT TL/Ad
4300	<b>Opak Seri Düz Uçlu Tornavida</b> / Opak Screwdriver, Flat 4x100-5x125-6x150-8x175	4	1.753,25
4320	<b>Opak Seri Yıldız Uçlu Tornavida</b> / Opak Screwdriver, Phillips 4.5x80-6x100	2	
5800	<b>Tesviyeci Çekiç</b> / Mechanist Hammer 300 gr	1	
5850	<b>Plastik Çekiç</b> / Plastic Hammer ø30	1	
5545	<b>Konik Pim Zimba</b> / Drift Punch 5 mm	1	
5550	<b>Düz Pim Zimba</b> / Split Pin Punch 5 mm	1	
5540	<b>Nokta Zimba</b> / Center Punch 5x120	1	
5500	<b>Düz Keski</b> / Flat Cold Chisel 150 mm	1	
4920	<b>T Tipi Allen Anahtar</b> / T Type Hex Key Wrench 3-4-5-6-7-8	6	





## 8242 GARAJ SERİSİ / GARAGE SERIES

Garaj Serisi Takım Dolabı ( 5-6-7-8 Çekmeceli )  
 Garage Series Workshop Trolley ( 5-6-7-8 Drawers )

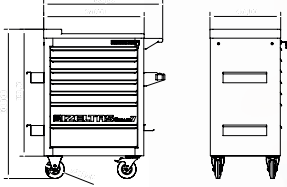

Ölçü/Size: 470x670x1010 mm

Sacdan imal edilmiş, Fırın boya  
 Made of sheet metal, Electrostatic paint



✓ Ergonomik sap  
 ● Ergonomic handle



✓ 8 Bölmeli, sağlam ABS tabla  
 ● Durable ABS worktop with divisions



✓ Havluluk x1  
 Avadanlık x2 Askılık x1  
 ● Paper Roll Holder  
 x 1 Bottle & Tins Holder x2 Hanger x1



✓ %100 açılabilir teleskobik raylar  
 ● %100 extendable telescopic slides



✓ Merkezi kilit sistemi, mandal sistemi devrilme emniyet sistemi.  
 ● Central locking, system handgrip lock system antitilt system



✓ 2 sabit, 2 hareketli frenli tekerlek Ø 125mm  
 ● 2 swivel castors with brake 2 fixed castors Ø 125 mm



✓ Yüksek dayanımlı elektrostatik toz boya.  
 ● High strength electrostatic powder coating



KOD/CODE	ÇEKMECE DRAWERS	35 kg	35 kg	35 kg	KG	RENK COLORS	FİYAT TL/Ad
		400x548x68	400x548x143	400x548x218			
8242 32 1005	5	1X	4X	--	59		9.593,75
8242 32 1006	6	4X	1X	1X	62		11.292,50
8242 32 1007	7	5X	2X	--	65		13.194,00
8242 32 1008	8	7X	1X	--	67		14.484,00
8242 32 2005	5	1X	4X	--	59		9.593,75
8242 32 2006	6	4X	1X	1X	62		11.292,50
8242 32 2007	7	5X	2X	--	65		13.194,00
8242 32 2008	8	7X	1X	--	67		14.484,00
8242 32 3005	5	1X	4X	--	59		9.593,75
8242 32 3006	6	4X	1X	1X	62		11.292,50
8242 32 3007	7	5X	2X	--	65		13.194,00
8242 32 3008	8	7X	1X	--	67		14.484,00
8242 00 1142 Dolu/Full 139 Parça/Pcs	7	5X	2X	--			26.274,75
8242 00 8142 Dolu/Full 139 Parça/Pcs	8	7X	1X	--			27.564,75

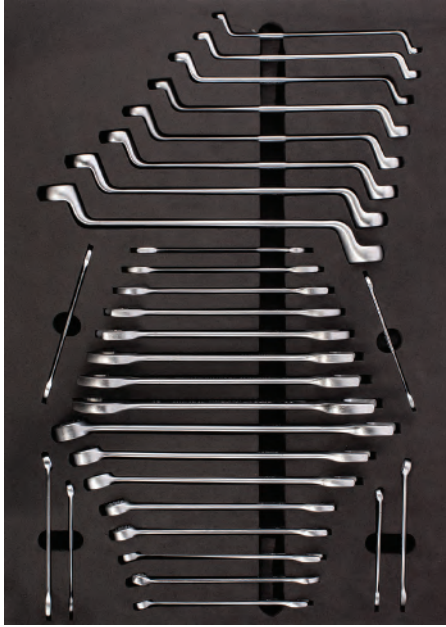

## 1. Garaj Seri Çekmece/Drawer

Kod / Code 8242001030

KOD CODE	İÇERİK CONTENTS	☐	FİYAT TL/Ad
0130	<b>İki Ağız Anahtar Uzun Boy</b> D/E Open Jaw Wrench Long Pattern 6x7 - 8x9 - 10x11 - 12x13 14x15 - 16x17 - 18x19 - 20x22 - 21x23 - 24x26	10	
0330	<b>Kombine Anahtar Uzun Boy</b> Combination Wrenches Long Pattern 6 - 7 - 8 - 9 - 10 - 11 - 12 - 13 - 14 - 17 - 19 - 22	12	2.280,25
0430	<b>Yıldız Anahtar</b> Ring Wrench 6x7 - 8x9 - 10x11 - 12x13 - 14x15 - 16x17 18x19 - 20x22	8	

## 2. Garaj Seri Çekmece/Drawer

Kod / Code 8242002072



KOD CODE	İÇERİK CONTENTS	☐	FİYAT TL/Ad
1113	<b>1/2" Lokmalı Allen Uçlar</b> Hexagonal Bits Socket H5-H6-H7-H8-H10-H12-H14	7	
1113	<b>1/2" Lokmalı Star Uç / 1/2 Star Bits Socket</b> T20-T25-T27-T30-T40-T45-T50-T55-T60	9	
0330	<b>Kombine Anahtar Uzun Boy</b> Combination Pliers Long 16-18	2	
4900	<b>Allen Takımı Altı Köşe / Hex Key Wrench Set</b> 2-2.5-3-3.5-4-5-6-7-8-9-10-12	12	
1107	<b>1/4" Altı Köşe Lokma Takımı</b> Socket Wrench Set 4 - 5 - 6 7 - 8 - 9 - 10 11 - 12 - 13 <b>Altı Köşe</b> Six Points	15	4.544,00
	<b>1/4" Cırcır Kolu</b> Ratchet Handle		
	<b>1/4" Mafsal</b> Universal Joint		
	<b>1/4" T Kol / Sliding T Handle</b>		
	<b>1/4" Ara Kol / Extension Bar 50 -100 mm</b>		
	<b>1/2" Lokma Takımı</b> Socket Wrench Set		
1113	<b>1/2" Cırcır Kolu 32 Diş</b> Ratchet Handle 10 - 11 - 12 13 - 14 - 15 16 - 17 - 18 19 - 21 - 22 23 - 24 - 26 27 - 28 - 30 32 <b>Altı Köşe</b> Six Points	24	
	<b>1/2" Mafsal</b> Universal Joint		
	<b>1/2" T Kol Adaptör</b> Sliding T Handle Adapter		
	<b>1/2" Ara Kol</b> Extension Bar 125-250 mm		

**3. Garaj Seri Çekmece/Drawer**

Kod / Code 8242003010

KOD CODE	İÇERİK CONTENTS	☐	FİYAT TL/Ad
3331	<b>İç Eğri Segman Pense</b> Circlip Pliers Internal (Bent) 170 mm	1	3.112,75
3321	<b>İç Düz Segman Pense</b> Circlip Pliers Internal (Flat) 180 mm	1	
3311	<b>Dış Eğri Segman Pense</b> Circlip Pliers External (Bent) 170 mm	1	
3301	<b>Dış Düz Segman Pense</b> Circlip Pliers External (Flat) 180 mm	1	
3700	<b>Yan Keski Opak Seri</b> Side Cutting Pliers 160 mm	1	
3220	<b>Düz Kargaburun Opak Seri</b> Nose Pliers (Flat) 200 mm	1	
3020	<b>Kombine Pense Opak Seri</b> Combination Pliers 180 mm	1	
2510	<b>Ayarlı Pense / Special</b> 250 mm	1	
0600	<b>Kurbağacık Anahtar / Adjustable Wrench</b> 10"	1	
2400	<b>Üniversal Fort Pense / Waterpump Pliers</b> Universal 240 mm	1	

**4. Garaj Seri Çekmece/Drawer**

Kod / Code 8242004018

KOD CODE	İÇERİK CONTENTS	☐	FİYAT TL/Ad
4300	<b>Opak Seri Düz Uçlu Tornavida</b> Screwdriver, Opak Flat 4x100-5x125-6x150-8x175	4	1.753,25
4320	<b>Opak Seri Yıldız Uçlu Tornavida</b> Screwdriver, Opak Philips 4.5x80-6x100	2	
5800	<b>Tesviyeci Çekiç</b> Machinist's Hammer 300 gr	1	
5850	<b>Plastik Çekiç</b> Plastic Hammer ø30	1	
5545	<b>Konik Pim Zimba</b> Drift Punch 5 mm	1	
5550	<b>Düz Pim Zimba</b> Split Pin Punch 5 mm	1	
5540	<b>Nokta Zimba</b> Center Punch 5x120	1	
5500	<b>Düz Keski</b> Flat Cold Chisel 150 mm	1	
4920	<b>T Tipi Allen Anahtar / Hex Key Wrench</b> 3-4-5-6-7-8	6	

**5. Garaj Seri Çekmece/Drawer**

Kod / Code 8242005011

KOD CODE	İÇERİK CONTENTS	☐	FİYAT TL/Ad
07415	<b>Sıralı Tel Fırça 3 Sıralı</b> Hand Brush 3 Raws	1	1.390,50
6350	<b>Levye Oluklu</b> Tyre Lever, Straight 400 mm	1	
6220	<b>Spiralli Mıknatıs</b> Flexible Magnet Holder 500 gr	1	
4110	<b>Düz Topaç Tornavida</b> Screwdriver Stubby Flat 6.5x25	1	
4130	<b>Yıldız Topaç Tornavida</b> Screwdriver Stubby Phillips 6x25	1	
4770	<b>Lokma Uçlu Tornavida</b> Nut Spinner 6-7-8-9-10-13	6	



## 8235 PARTNER SERİSİ / PARTNER SERIES

Partner Mobil Takım Dolabı ( 5 Çekmeceli )  
 Partner Workshop Trolley ( 5 Drawers )



- ✓ Merkezi kilit sistemi ve mandal sistemi.
- Central lock system and handgrip lock system.



- ✓ Teleskobik rulmanlı kızaklar tüm çekmeceler %100 açılabilir.
- Telescopic slides which are %100 extendable.



- ✓ 8 Bölmeli, sağlam ABS tabla
- 8 Durable ABS worktop with divisions



- ✓ 2 sabit, 2 hareketli frenli tekerlek ø 100mm
- 2 swivel castors with brake
- 2 fixed castors ø 100 mm



- ✓ Yüksek dayanımlı elektrostatik toz boya.
- High strength electrostatic powder coating

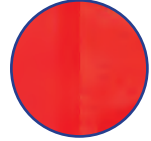

Ölçü/Size: 470x670x975 mm

Sacdan imal edilmiş, Fırın boya  
 Made of sheet metal, Electrostatic paint

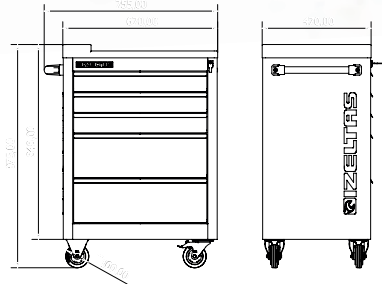







RAL 3020



RAL 5003



RAL 9005

KOD/CODE	ÇEKMECE DRAWERS	 35 kg	 35 kg	 KG	RENK COLORS	FİYAT TL/Ad
8235 32 6005	5	3X	2X	56	 RAL 3020	8.728,50
8235 32 5005	5	3X	2X	56	 RAL 5003	8.728,50
8235 32 7005	5	3X	2X	56	 RAL 9005	8.728,50
8235 00 6121 Dolu/Full 118 Parça/Pcs	5	3X	2X			18.330,25



## 1. Partner Seri Çekmece/Drawer

Kod / Code 8235001072

KOD CODE	İÇERİK CONTENTS	□	FİYAT TL/Ad
1107	<p><b>1/4" Altı Köşe Lokma Takımı</b> 1/4" Socket Wrench Set</p> <p>4 - 5 - 6 7 - 8 - 9 - 10 11 - 12 - 13 <b>Altı Köşe</b> Six Points</p>	15	
1113	<p><b>1/4" Cırcır kolu</b> Ratchet Handle</p> <p><b>1/4" Mafsal</b> Universal Joint</p> <p><b>1/4" T Kol</b> Sliding T Handle</p> <p><b>1/4" Ara Kol</b> Extention Bar 50-100 mm</p> <p><b>1/2" Lokma Takımı</b> 1/2" Socket Set</p> <p><b>1/2" Cırcır Kolu 32 Diş</b> Ratchet Handle</p> <p><b>1/2" Mafsal</b> Universal Joint</p> <p><b>1/2" T Kol Adaptör</b> Sliding T Handle Adapter</p> <p><b>1/2" Ara Kol</b> Extention Bar 125-250 mm</p>	24	5.117,50
1507	<p><b>1/4" Derin Lokma Tornavida Adaptörü</b> Spindle Handle</p>	1	
4900	<p><b>12 'li Allen Anahtar Takımı</b> Hex Key Wrench Set 2-2.5-3-3.5-4-5-6-7-8-9-10-12 mm</p>	12	
4910	<p><b>8 'li Torx Allen Anahtar Takımı</b> Torx Key Wrench T9-T10-T15-T20-T25-T27-T30-T40</p>	8	
1108	<p><b>1/2" Altı Köşe Derin Lokma</b> Deep Socket Wrench 6 Point 10-13-16-17-18-19 mm</p>	6	
1113	<p><b>1/2" 16 mm Buji Lokma Anahtar</b> Spark Plug Socket With Rubber</p>	1	
2400	<p><b>240 mm Üniversal Fort Pense</b> Waterpump Pliers, Universal</p>	1	
2500	<p><b>250 mm Üniversal Ayarlı Pense</b> Universal Grip</p>	1	

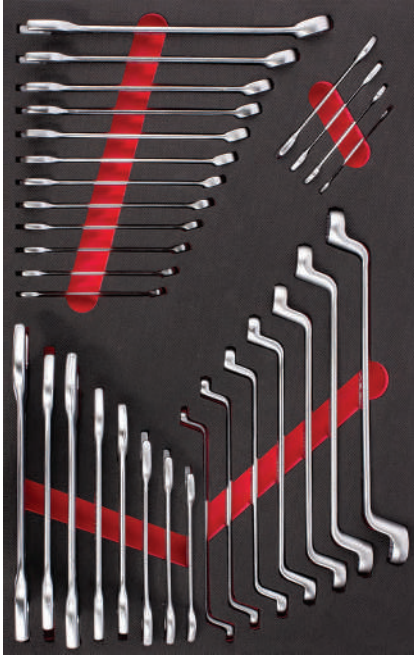

## 2. Partner Seri Çekmece/Drawer

Kod / Code 8235002031

KOD CODE	İÇERİK CONTENTS	□	FİYAT TL/Ad
0100	<b>İki Ağız Anahtar Kısa Boy</b> Double Ended Open Jaw Wrench Short Pattern 6x7 - 8x9 - 10x11 - 12x13 14x15 - 16x17 - 18x19 - 20x22 21x23 - 24x26 - 25x28 - 30x32	12	
0320	<b>Kombine Anahtar Kısa Boy</b> Combination Wrench Short Pattern 8 - 9 - 10 - 11 - 12 - 13 14 - 15 - 16 - 17 - 19 - 22	12	2.272,25
0430	<b>Yıldız Anahtar</b> Ring Wrench 8x9 - 10x11 - 12x13 - 14x15 - 16x17 18x19 - 20x22	7	



## 3. Partner Seri Çekmece/Drawer

Kod / Code 8235003017

KOD CODE	İÇERİK CONTENTS	□	FİYAT TL/Ad
4300	<b>Opak Seri Düz Uçlu Tornavida</b> Screwdriver, Opak Flat 3x80-4x80-4x100-5x125-6x150	5	
4320	<b>Opak Seri Yıldız Uçlu Tornavida</b> Screwdriver, Opak Philips 4.5x80-6x100	2	
3700	<b>Yan Keski Opak Seri</b> Side Cutting Pliers 160 mm	1	
3020	<b>Kombine Pense Opak Seri</b> Combination Pliers 180 mm	1	2.212,00
3220	<b>Düz Kargaburun Opak Seri</b> Nose Pliers Flat 200 mm	1	
4770	<b>Lokma Uçlu Tornavida</b> Nut Spinner 6-7-8-10-13	5	
5500	<b>Düz Keski</b> Flat Cold Chisel 150 mm	1	
5800	<b>Tesviyecı Çekiçi</b> Machinist's Hammer 500 gr	1	



## 8243 EKO SERİSİ / ECO SERIES

Eko Serisi Takım Dolabı ( 3-5-7 Çekmeceli )  
Eco Series Workshop Trolley ( 3-5-7 Drawers )



Ölçü/Size: 410x620x894 mm

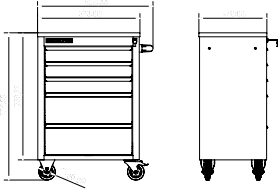

IZELTAS YOUTUBE

Sacdan imal edilmiş, Fırın boya  
Made of sheet metal, Electrostatic paint



- ✓ Merkezi kilit
- Central locking



- ✓ %100 açılabilir teleskobik raylar.
- %100 extendable telescopic slides



- ✓ Yüksek dayanımlı elektrostatik toz boya.
- High strength electrostatic powder coating

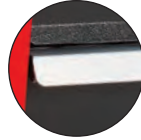



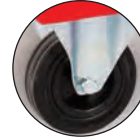

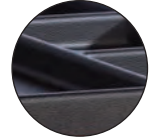

- ✓ Eloksallı alüminyum tutma çitəsi.
- Handle with anodised aluminum



- ✓ 2 sabit, 2 hareketli frenli tekerlek ø 100 mm
- 2 swivel castors with brake
- 2 fixed castors ø 100 mm



- ✓ 4 bölümlü sağlam ve dayanıklı ABS plastik üst malzeme tabla.
- Resistant and solid top cover with 4 divisions

KOD/CODE	ÇEKMECE DRAWERS	 35 kg	 35 kg	DEMONTÉ RAF DISASSEMBLED SHELF	 Kg	RENK COLORS	FİYAT TL/Ad
8243 32 1003	3	3x	--	2	43		6.367,50
8243 32 1005	5	3X	2X	--	43		6.367,50
8243 32 1007	7	7X	--	--	43		8.536,50
8243 32 2005	5	3X	2X	--	43		6.367,50
8243 32 2007	7	7X	--	--	43		8.536,50
8243 32 3005	5	3X	2X	--	43		6.367,50
8243 32 3007	7	7X	--	--	43		8.536,50
8243 00 1096 Dolu/Full 93 Parça/Pcs	5	3X	2X	--			14.049,25
8243 00 7096 Dolu/Full 93 Parça/Pcs	7	7X	--	--			16.218,25

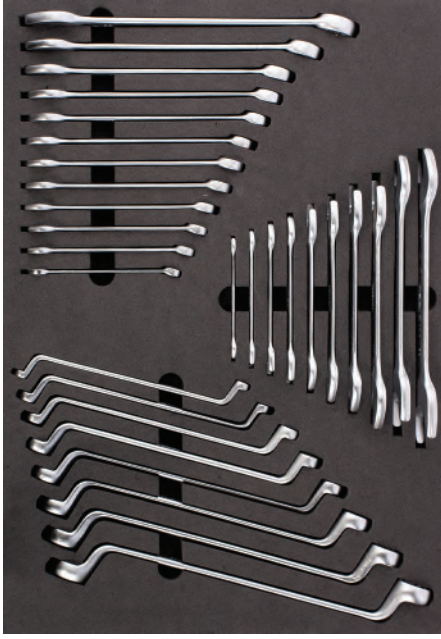

**1. Eko Seri Çekmece/Drawer**

Kod / Code 8243001030

KOD/CODE	İÇERİK CONTENTS	☐	TL/Ad.
0100	<b>İki Ağız Anahtar Kısa Boy</b> D/E Open Jaw Wrench Short Pattern 6x7 - 8x9 - 10x11 - 12x13 14x15 - 16x17 - 18x19 - 20x22 - 21x23 - 24x26	10	
0320	<b>Kombine Anahtar Kısa Boy</b> Combination Wrench Short Pattern 8 - 9 - 10 - 11 - 12 - 13 - 14 - 15 - 16 - 17 - 19 - 22	12	2.144,00
0430	<b>Yıldız Anahtar</b> Ring Wrench 6x7 - 8x9 - 10x11 - 12x13 - 14x15 - 16x17 18x19 - 20x22	8	

**2. Eko Seri Çekmece/Drawer**

Kod / Code 8243002052

KOD/CODE	İÇERİK CONTENTS	☐	TL/Ad.
1113	<b>1/2" 17'li Lokma Takımı</b> Socket Wrench Set 1/2" mm 10 - 11 - 12 - 13 - 14 - 15 - 17 - 19 22 - 24 - 27 - 30 - 32 250 - 250 - 70 <b>1/2" T Kol Adaptör</b> Sliding T Handle Adapte	17	
1107	<b>1/4" Altı Köşe Lokma Takımı</b> Socket Wrench Set 1/4"mm 4 - 5 - 6 - 7 - 8 - 9 - 10 - 11 - 12 - 13 140 - 115 - 100 - 50 - 38	15	3.248,50
4900	<b>Allen Anahtar Takımı</b> Hex Key Wrench Set 2 - 2.5 - 3 - 3.5 - 4 - 5 - 6 - 7 - 8 - 9 - 10 - 12	12	
4770	<b>Lokma Uçlu Tornavidalar</b> Nutspinners 6 - 7 - 8 - 10 - 13	5	

**3. Eko Seri Çekmece/Drawer**

Kod / Code 8243003013

KOD/CODE	İÇERİK CONTENTS	☐	TL/Ad.
4320	<b>Opak Seri Yıldız Uçlu Tornavida</b> Opak Screwdriver, Phillips 4,5x80-6x100	2	
4300	<b>Opak Seri Düz Uçlu Tornavida</b> Opak Screwdriver, Flat 4x100-5x125-6x150-8x175	4	
3700	<b>Yan Keski Opak Seri</b> Side Cutting Pliers 160 mm	1	
3020	<b>Kombine Pense Opak Seri</b> Combination Pliers 180 mm	1	
3220	<b>Kargaburun Düz Uçlu Opak Seri</b> Nose Pliers, Flat 160 mm	1	2,289,25
5500	<b>Düz Keski Krom</b> Flat Cold Chisel 150 mm	1	
5800	<b>Tesviyecı Çekici</b> Machinist's Hammer 300 gr	1	
2510	<b>Spesiyal Ayarlı Pense / Special Grip 250 mm</b>	1	
2400	<b>Üniversal Fort Pense / Waterpump Pliers Universal 240 mm</b>	1	

Trend Serisi Takım Dolabı ( 5-7 Çekmeceli )  
Trend Series Workshop Trolley ( 5-7 Drawers )



✓ 4 bölmeli sağlam ve dayanıklı  
ABS plastik üst malzeme tabla.  
● Resistant and solid  
top cover with 4 divisions

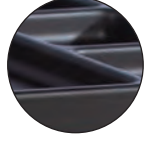

✓ %100 açılabilir teleskobik raylar.  
● %100 extendable telescopic slides



✓ Merkezi kilit  
● Central locking



✓ 2 sabit, 2 hareketli  
frenli tekerlek ø 100 mm  
● 2 swivel castors with brake  
2 fixed castors ø 100 mm



✓ Yüksek dayanımlı elektrostatik toz boya  
● High strength electrostatic powder coating

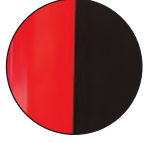

✓ Kendiliğinden açılmayı engelleyen  
plastik kilit  
● Plastic lock preventing self opening

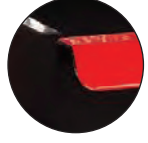



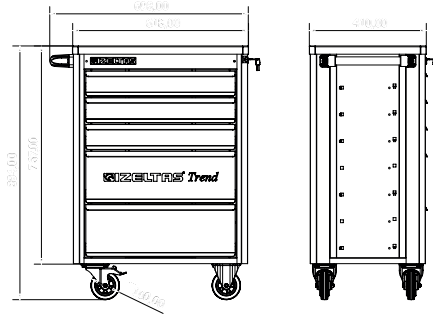

Ölçü/Size: 410x618x894 mm



İZELTAS YOUTUBE

Sacdan imal edilmiş, Fırın boya  
Made of sheet metal, Electrostatic paint

KOD/CODE	ÇEKMECE DRAWERS	 350x503x82	 350x503x176	 Kg	RENK COLORS	FİYAT TL/Ad
8244 32 1005	5	3X	2X	43		6.393,00
8244 32 1007	7	7X	--	43		6.656,50
8244 00 5096 Dolu/Full 93 Parça/Pcs	5	3X	2X			14.074,75
8244 00 7096 Dolu/Full 93 Parça/Pcs	7	7X	--			14.338,25

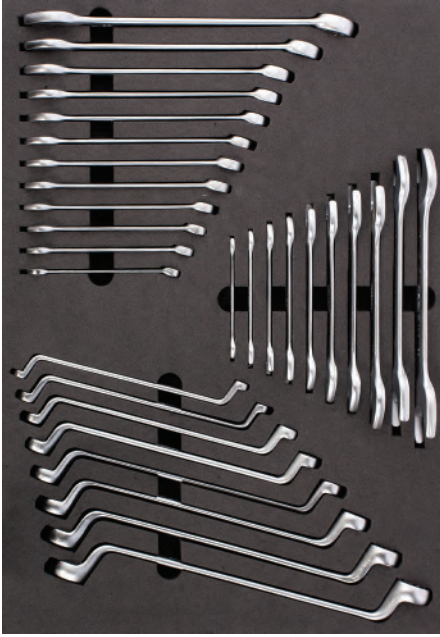
**1. Trend Seri Çekmece/Drawer** Kod / Code 8244001030

KOD/CODE	İÇERİK CONTENTS	☐	TL/Ad.
0100	<b>İki Ağız Anahtar Kısa Boy</b> D/E Open Jaw Wrench Short Pattern 6x7 - 8x9 - 10x11 - 12x13 14x15 - 16x17 - 18x19 - 20x22 - 21x23 - 24x26	10	2.144,00
0320	<b>Kombine Anahtar Kısa Boy</b> Combination Wrench Short Pattern 8 - 9 - 10 - 11 - 12 - 13 - 14 - 15 - 16 - 17 - 19 - 22	12	
0430	<b>Yıldız Anahtar</b> Ring Wrench 6x7 - 8x9 - 10x11 - 12x13 - 14x15 - 16x17 18x19 - 20x22	8	

**2. Trend Seri Çekmece/Drawer** Kod / Code 8244002052

KOD/CODE	İÇERİK CONTENTS	☐	TL/Ad.
1113	<b>1/2" 17'li Lokma Takımı</b> Socket Wrench Set 1/2" mm 10 - 11 - 12 - 13 - 14 - 15 - 17 - 19 22 - 24 - 27 - 30 - 32 250 - 250 - 70	17	3.248,50
1107	<b>1/4" Altı Köşe Lokma Takımı</b> Socket Wrench Set 1/4" mm 4 - 5 - 6 - 7 - 8 - 9 - 10 - 11 - 12 - 13 140 - 115 - 100 - 50 - 38	15	
4900	<b>Allen Anahtar Takımı</b> Hex Key Wrench Set 2 - 2.5 - 3 - 3.5 - 4 - 5 - 6 - 7 - 8 - 9 - 10 - 12	12	
4770	<b>Lokma Uçlu Tornavidalar</b> Nutspinners 6 - 7 - 8 - 10 - 13	5	

**3. Trend Seri Çekmece/Drawer** Kod / Code 8244003013

KOD/CODE	İÇERİK CONTENTS	☐	TL/Ad.
4320	<b>Opak Seri Yıldız Uçlu Tornavida</b> Opak Screwdriver, Phillips 4.5x80-6x100	2	2.289,25
4300	<b>Opak Seri Düz Uçlu Tornavida</b> Opak Screwdriver, Flat 4x100-5x125-6x150-8x175	4	
3700	<b>Yan Keski Opak Seri</b> Side Cutting Pliers 160 mm	1	
3020	<b>Kombine Pense Opak Seri</b> Combination Pliers 180 mm	1	
3220	<b>Kargaburun Düz Uçlu Opak Seri</b> Nose Pliers, Flat 160 mm	1	
5500	<b>Düz Keski Krom</b> Flat Cold Chisel 150 mm	1	
5800	<b>Tesviyeci Çekici</b> Machinist Hammer 300 gr	1	
2510	<b>Special Ayarlı Pense / Special Grip 250 mm</b>	1	
2400	<b>Üniversal Fort Pense / Waterpump Pliers Universal 240 mm</b>	1	

### Takım Dolabı Ahşap Üst Tablalı XXL ( 7 Çekmeceli ) XXL Series Workshop Trolley ( 7 Drawers )

**YENİ  
NEW**

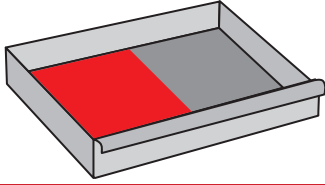

Aşağıda yazılı olan muhteviyatlı süngerlerden her bir çekmeceye İKİ (2) adet yerleştirilebilir.

- |                                |                       |
|--------------------------------|-----------------------|
| 1. Premium Seri Çekmece/Drawer | Kod / Code 8245001042 |
| 2. Premium Seri Çekmece/Drawer | Kod / Code 8245002094 |
| 3. Premium Seri Çekmece/Drawer | Kod / Code 8245003014 |
| 4. Premium Seri Çekmece/Drawer | Kod / Code 8245004043 |
| 5. Premium Seri Çekmece/Drawer | Kod / Code 8245005043 |
| 6. Premium Seri Çekmece/Drawer | Kod / Code 8245006009 |
| 1. Pro Seri Çekmece/Drawer     | Kod / Code 8241001030 |
| 2. Pro Seri Çekmece/Drawer     | Kod / Code 8241002072 |
| 3. Pro Seri Çekmece/Drawer     | Kod / Code 8241003051 |
| 4. Pro Seri Çekmece/Drawer     | Kod / Code 8241004027 |
| 5. Pro Seri Çekmece/Drawer     | Kod / Code 8241005010 |
| 6. Pro Seri Çekmece/Drawer     | Kod / Code 8241006018 |
| 1. Garaj Seri Çekmece/Drawer   | Kod / Code 8242001030 |
| 2. Garaj Seri Çekmece/Drawer   | Kod / Code 8242002072 |
| 3. Garaj Seri Çekmece/Drawer   | Kod / Code 8242003010 |
| 4. Garaj Seri Çekmece/Drawer   | Kod / Code 8242004018 |
| 5. Garaj Seri Çekmece/Drawer   | Kod / Code 8242005011 |
| 1. Partner Seri Çekmece/Drawer | Kod / Code 8235001072 |
| 2. Partner Seri Çekmece/Drawer | Kod / Code 8235002031 |
| 3. Partner Seri Çekmece/Drawer | Kod / Code 8235003017 |

Ölçü/Size: 470x1224x964 mm

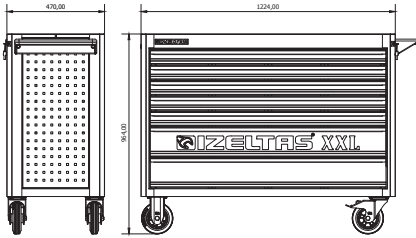

- ✓ 18mm masif üst tabla
- 18 mm solid wood top



- ✓ %100 açılabilir teleskobik raylar.
- %100 extendable telescopic slides



- ✓ Devrilme emniyet sistemi
- Handgrip Lock system
- Anti tilt system

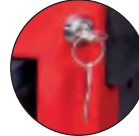

- ✓ Ergonomik sap
- Ergonomic handle

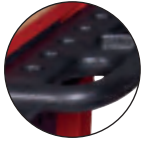

- ✓ 2 sabit, 2 hareketli frenli tekerlek ø 150mm
- 2 swivel castors with brake
- 2 fixed castors ø 150mm



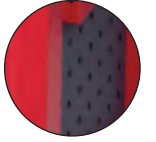

- ✓ Yüksek dayanımlı elektrostatik toz boya.
- High strength electrostatic powder coating.



- ✓ 10 adet seperetör A4 avadanlık
- 10 separators A4 kit



Sacdan imal edilmiş, Fırın boya  
Made of sheet metal, Electrostatic paint

KOD/CODE	ÇEKMECE DRAWERS				RENK COLORS	FİYAT TL/Ad
		1098x400x60	1098x400x135			

8246 32 1007

7

5X

2X

RAL 7016  
RAL 3020

16.006,00

**Takım Dolabı Ahşap Üst Tablalı Workbench ( 7 Çekmeceli )**  
**Workbench Series Workshop Trolley ( 7 Drawers )**

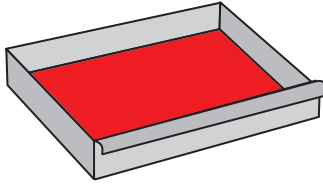

Aşağıda yazılı olan muhteviyatlı süngerlerden her bir çekmeceye BİR (1) adet yerleştirilebilir.

- |                                |                       |
|--------------------------------|-----------------------|
| 1. Premium Seri Çekmece/Drawer | Kod / Code 8245001042 |
| 2. Premium Seri Çekmece/Drawer | Kod / Code 8245002094 |
| 3. Premium Seri Çekmece/Drawer | Kod / Code 8245003014 |
| 4. Premium Seri Çekmece/Drawer | Kod / Code 8245004043 |
| 5. Premium Seri Çekmece/Drawer | Kod / Code 8245005043 |
| 6. Premium Seri Çekmece/Drawer | Kod / Code 8245006009 |
| 1. Pro Seri Çekmece/Drawer     | Kod / Code 8241001030 |
| 2. Pro Seri Çekmece/Drawer     | Kod / Code 8241002072 |
| 3. Pro Seri Çekmece/Drawer     | Kod / Code 8241003051 |
| 4. Pro Seri Çekmece/Drawer     | Kod / Code 8241004027 |
| 5. Pro Seri Çekmece/Drawer     | Kod / Code 8241005010 |
| 6. Pro Seri Çekmece/Drawer     | Kod / Code 8241006018 |
| 1. Garaj Seri Çekmece/Drawer   | Kod / Code 8242001030 |
| 2. Garaj Seri Çekmece/Drawer   | Kod / Code 8242002072 |
| 3. Garaj Seri Çekmece/Drawer   | Kod / Code 8242003010 |
| 4. Garaj Seri Çekmece/Drawer   | Kod / Code 8242004018 |
| 5. Garaj Seri Çekmece/Drawer   | Kod / Code 8242005011 |
| 1. Partner Seri Çekmece/Drawer | Kod / Code 8235001072 |
| 2. Partner Seri Çekmece/Drawer | Kod / Code 8235002031 |
| 3. Partner Seri Çekmece/Drawer | Kod / Code 8235003017 |

**Ölçü/Size: 500x1150x991 mm**

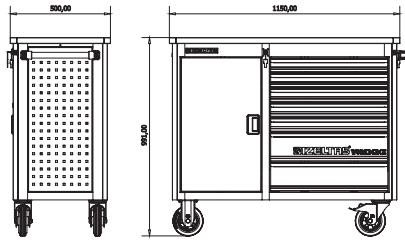

✓ 30 mm masif ahşap üst tabla  
 ● 30 mm solid wood top

✓ %100 açılabilir teleskobik raylar.  
 ● %100 extendable telescopic slides

✓ Merkezi kilit  
 ✓ Mandal sistemi  
 ✓ Devrilme emniyet sistemi  
 ● Central lock  
 ● Handgrip Lock system  
 ● Anti tilt system

✓ Standard tutma sapı  
 ● Standard handle

✓ 2 sabit, 2 hareketli frenli tekerlek ø 150mm  
 ● 2 swivel castors with brake  
 2 fixed castors ø 150mm

✓ Yüksek dayanımlı elektrostatik toz boya.  
 ● High strength electrostatic powder coating.

✓ 4 kısa, 2 uzun seperetör  
 ● 4 Short, 2 long separators

Sacdan imal edilmiş, Fırın boya  
 Made of sheet metal, Electrostatic paint

KOD/CODE	ÇEKMECE DRAWERS	35 kg 400x548x60	35 kg 400x548x134	Kg	RENK COLORS	FİYAT TL/Ad
8247 32 1007	7	5X	2X		RAL 7016 RAL 3020	15.020,75

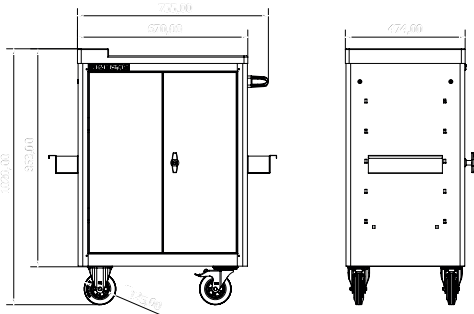
**Vagon Serisi Takım Dolabı**  
*Wagon Series Workshop Trolley***Ölçü/Size: 474x670x1020 mm**

- ✓ 8 Bölmeli, sağlam ABS tabla
- Durable ABS worktop with divisions



- ✓ Kilit T kol
- Locked T-handle



- ✓ 2 Sabit, 2 hareketli frenli tekerlek ø 125mm
- 2 swivel castors with brake 2 fixed castors ø 125 mm



- ✓ Yüksek dayanımlı elektrostatik toz boya.
- High strength electrostatic powder coating



- ✓ 2X ayarlanabilir raf (10 adet seperatör ile)
- 2x adaptable shelves with seperator 10 pcs



- ✓ Standard tutma sapı
- Standard handle



- ✓ 2X avadanlık
- 2X tin holder

**Sacdan imal edilmiş, Fırın boya**  
*Made of sheet metal, Electrostatic paint*

KOD/CODE	Ölçü / SIZE (mm)	⚖ Kg	RENK COLORS	FİYAT TL/AD
----------	------------------	---------	----------------	----------------

8210 32 6001

474x670x1020

45

RAL 7016  
RAL 3020

6.734,25

**8160**
**Takım Dolabı**  
*Tool Cabinet*

- ✓ Kollu kilit
- Locked T-handle



- ✓ %100 açılabilir teleskobik raylar.
- %100 extendable telescopic slides



- ✓ 4 hareketli frenli tekerlek ø 50mm
- 4 swivel castors with brake ø 50 mm



- ✓ Yüksek dayanımlı elektrostatik toz boya.
- High strength electrostatic powder coating



- ✓ Avadanlık x2
- Bottle and tins holder x2



- ✓ Askılık x4
- Hanger x4



- ✓ Özel askılık x4
- Special hanger x4



- ✓ Anahtar askısı x1
- Hanger for wrenches x1

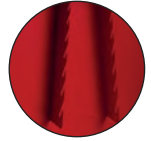

- ✓ Özel avadanlık x1
- Special tin holder x1

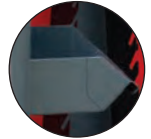

- ✓ Matkap ucu tutucu x1
- Drill bits holder x1

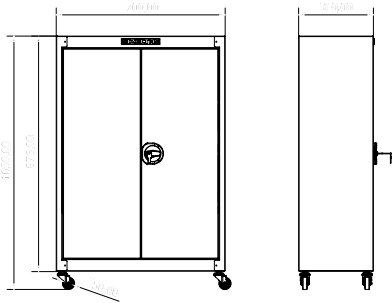
**Ölçü/Size: 310x700x1050 mm**

 Sacdan imal edilmiş, Fırın boya  
 Made of sheet metal, Electrostatic paint

KOD/CODE	20 kg	Ölçü / SIZE (mm)	Kg	COLORS	FİYAT TL/Ad.
228x567x58					

8160 32 6001

3x

310x700x1050

35

 RAL 7016  
 RAL 3020

6.073,50

**Demonte Mini Servis Arabası**  
*Disassembled Mini Service Trolley*

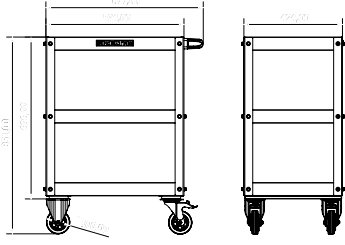

Çelik konstrüksiyon  
Steel construction

- **3X Kauçuk Kaydırmaz Mat**  
3X Rubber Anti Slipping Mats
- **2X Sabit, 2X Hareketli Frenli Tekerlek (ø 100 mm)**  
2X Fixed, 2X Swivel Castors with Brake (ø 100 mm)
- **Sağlam sac metal yapı, Her raf 50 Kg taşır.**  
Robust sheet-steel construction, Loading capacity per shelf 50 Kg

KOD/CODE	420x590x57	Ölçü / SIZE (mm)	Kg	COLORS	FİYAT TL/Ad.
----------	------------	------------------	----	--------	--------------

8550 34 8001

3X

424x594x851

18

RAL 9005  
RAL 3020

2.894,00

**Demonte Mini Servis Arabası (kapalı)**  
*Disassembled Mini Service Trolley (closed)*

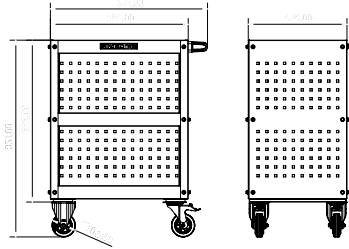

Çelik konstrüksiyon  
Steel construction

- **3X Kauçuk Kaydırmaz Mat**  
3X Rubber Anti Slipping Mats
- **2X Sabit, 2X Hareketli Frenli Tekerlek (ø 100 mm)**  
2X Fixed, 2X Swivel Castors with Brake (ø 100 mm)
- **Sağlam sac metal yapı, Her raf 50 Kg taşır.**  
Robust sheet-steel construction, Loading capacity per shelf 50 Kg
- **Arabanın yanları ve arkasında kare askı delikleri**  
Square-shaped perforation on the side panels and back panel offers individual fastening

KOD/CODE	420x590x57	Ölçü / SIZE (mm)	Kg	COLORS	FİYAT TL/Ad.
----------	------------	------------------	----	--------	--------------

8550 34 8002

3X

424x594x851

23

RAL 9005  
RAL 3020

3.337,50



## 8545

### Taşıma Arabası Platform Wagon

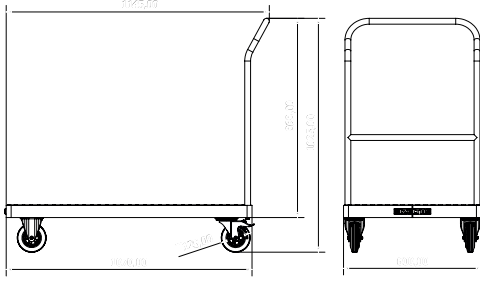

- **12mm PVC kaplı kontrplak Tabla**  
12mm PVC coated plywood
- **2X Sabit, 2X Hareketli Frenli Tekerlek (ø 125mm)**  
2X Fixed, 2X Swivel Castors with Brake (ø 125mm)
- **Sağlam sac metal yapı, Her raf 310 Kg taşır.**  
Robust sheet-steel construction, Loading capacity per shelf 310 Kg

Çelik konstrüksiyon  
Steel construction

KOD/CODE	Ölçü / SIZE (mm)	Kg	COLORS	FİYAT TL/Ad.
----------	------------------	----	--------	--------------

8545 34 1005

600x1145x1025

38

RAL 9005

8.768,00

## 8550

### Servis Arabası (Büyük Boy) Service Trolley (Large Size)

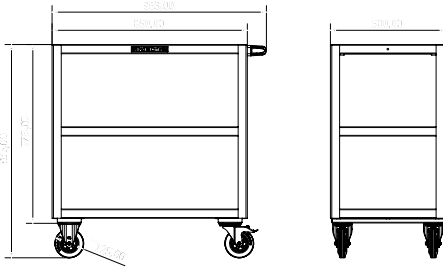

- **3X Kauçuk Kaydırmaz Mat**  
3X Rubber Anti Slipping Mats
- **2X Sabit, 2X Hareketli Frenli Tekerlek (ø 125 mm)**  
2X Fixed, 2X Swivel Castors with Brake (ø 125 mm)
- **Sağlam sac metal yapı, Her raf 75 Kg taşır.**  
Robust sheet-steel construction, Loading capacity per shelf 75 Kg

Çelik konstrüksiyon  
Steel construction

KOD/CODE	75 kg 494x844x40	Ölçü / SIZE (mm)	Kg	COLORS	FİYAT TL/Ad.
----------	---------------------	------------------	----	--------	--------------

8550 34 6001

3X

500x850x935

37

RAL 3020

4.806,25

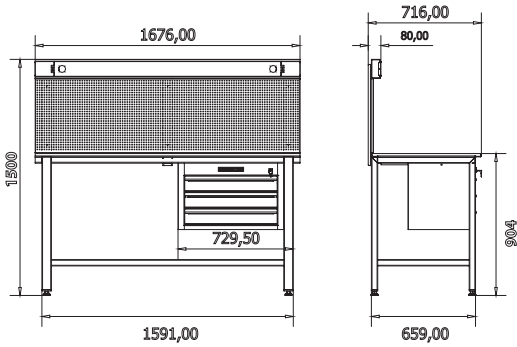
**Servis Masası (Panolu)**  
*Work Bench (With Panel)*

- **Merkezi kilit sistemi, mandal sistemi**  
Central locking system, handgrip lock system
- **Kaynaklı sağlam tasarım**  
Robust welded design
- **%100 Açılabilir teleskobik raylar**  
100% extendable telescopic slides
- **Yüksek dayanımlı elektrostatik toz boya.**  
High strength electrostatic powder paint
- **Delikli panel (220 V prizler ile).**  
Perforated panel with electrical plugs 220 V

Çelik Konstrüksiyon ve zor koşullarda çalışmaya elverişli  
Özel Plywood ahşap tezgah  
*Strong and durable steel construction and Plywood bench*

KOD/CODE		Ölçü / SIZE (mm)	 Kg	COLORS	FİYAT TL/Ad.
----------	---	------------------	---	--------	-----------------

8500 34 6001

3X

720x1680x1495

102



12.024,25

**8501**

Servis Masası (Panosuz)  
 Work Bench (Without Panel)

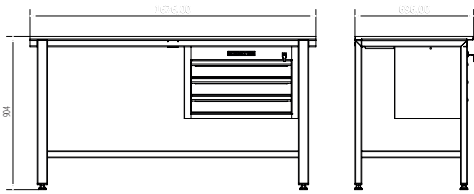

- **Merkezi kilit sistemi, mandal sistemi**  
Central locking system, handgrip lock system
- **Kaynaklı sağlam tasarım**  
Robust welded design
- **%100 Açılabilir teleskobik raylar**  
100% extendable telescopic slides
- **Yüksek dayanımlı elektrostatik toz boya.**  
High strength electrostatic powder paint

Çelik konstrüksiyon ve zor koşullarda çalışmaya elverişli  
 Özel Plywood ahşap tezgah  
 Strong and durable steel construction and Plywood bench

KOD/CODE		Ölçü / SIZE (mm)	 Kg	COLORS	FİYAT TL/Ad.
	348x548x90				

8501 34 6001

3X

700x1680x900

84

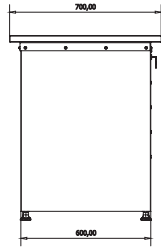
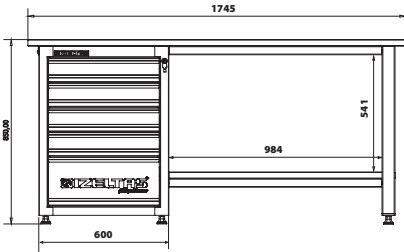

9.104,00

**Demonte Atölye Masası**  
*Disassembled Workbench***YENİ  
NEW**

- ✓ %100 açılabilir teleskobik raylar.
- %100 extendable telescopic slides





- ✓ Merkezi kilit
- ✓ Mandal sistemi
- Central lock
- Handgrip Lock system



- **Demonte sağlam tasarım**  
*Robust disassembled design*
- **30mm masif ahşap**  
*30 mm solid wood*
- **Ayarlanabilir ayaklar**  
*Height adjustable feet*

**Çelik konstrüksiyon**  
*Steel construction*

KOD/CODE	ÇEKMECE DRAWERS	 490x400x107	 490x400x221	 Kg	RENK COLORS	FİYAT TL/Ad
----------	--------------------	--	--	---	----------------	----------------

8502 34 6002

5

4X

1X

RAL 7016  
RAL 3020

30.739,75



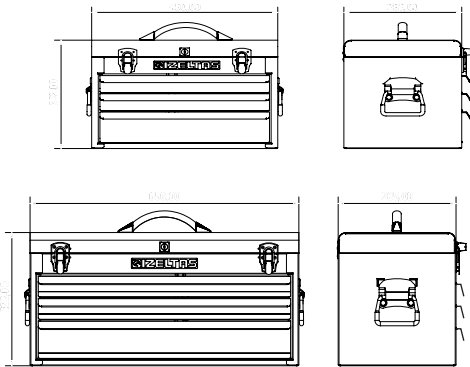

TOOL TROLLEYS  
TOOL BOXES

TANIM DOLAPLARI  
VE TANIM  
ÇANTALARI

**Çekmeceli Alet Sandığı**  
*Tool Chest With Drawers*

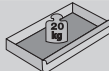
Sacdan imal edilmiş, Fırın boya  
*Made from metal sheet, Electrostatic paint*

KOD/CODE	Ölçü / SIZE (mm)	ÇEKMECE DRAWERS	 2x	 1x	 Kg	FİYAT TL/Ad
8320 33 1001	285x450x322	3X	238x370x47	238x370x87	16	3.993,50
8320 33 1003	285x650x322	3X	238x570x47	238x570x87	20	4.369,75

## 8410

### Takım Çantası (3 Gözlü) Tool Box (3 Trays)

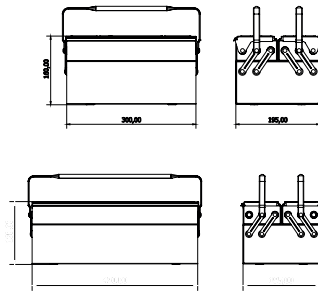

Sacdan imal edilmiş, Fırın boya  
Made from metal sheet, Electrostatic paint

KOD CODE	Ölçü / SIZE (mm)	g	1	FİYAT TL/Ad
8410 33 6103	195x300x160	2400	1	509,25
8410 33 6203	195x420x160	3000	1	608,75

## 8420

### Takım Çantası (5 Gözlü) Tool Box (5 Trays)

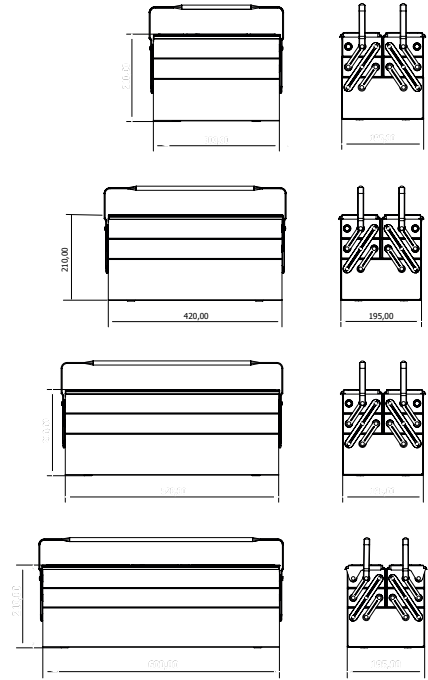
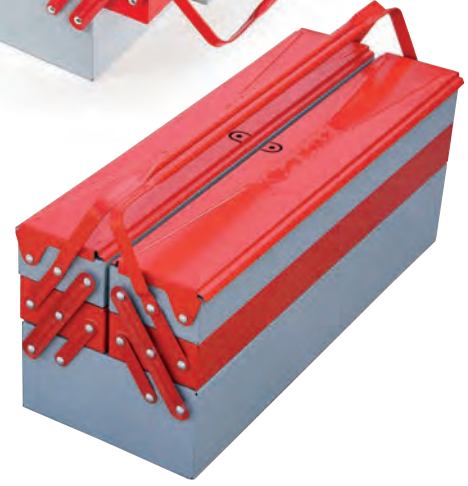

Sacdan imal edilmiş, Fırın boya  
Made from metal sheet, Electrostatic paint

KOD CODE	Ölçü / SIZE (mm)	g	1	FİYAT TL/Ad
8420 33 6105	195x300x210	3200	1	896,50
8420 33 6205	195x420x210	4200	1	928,25
8420 33 6305	195x520x210	5000	1	1.078,75
8420 33 6405	195x600x210	5600	1	1.136,75

Takım Çantası (5 Gözlü)  
Tool Box (5 Trays)

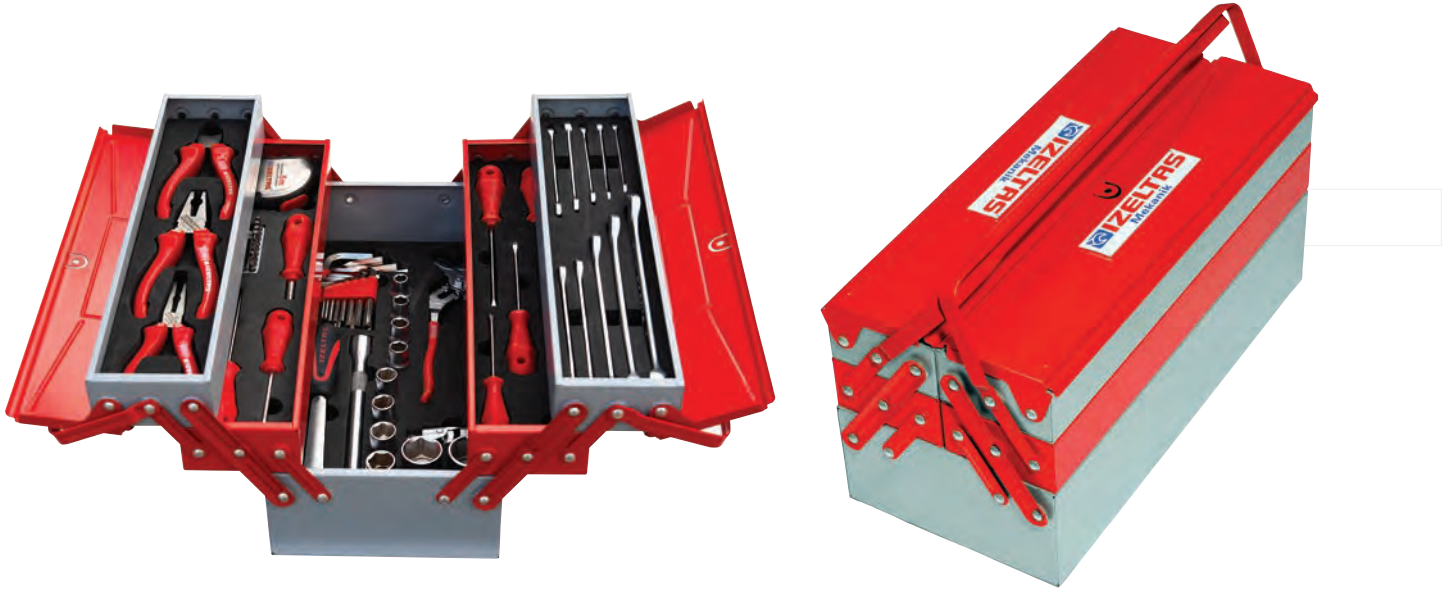
**8420 00 5063**

Mekanikçi Takım Çantası (62 Parça, 5 Gözlü)  
Tool Box for Mechanician (62 Pcs, 5 Trays)

**8420 00 5046**

Elektrikçi Takım Çantası (45 Parça, 5 Gözlü)  
Tool Box for Electrician (45 Pcs, 5 Trays)

**8420 00 5028**

Tesisatçı Takım Çantası (28 Parça, 5 Gözlü)  
Tool Box for Plumbers (28 Pcs, 5 Trays)





**8420 00 5063**
**Mekanikçi Takım Çantası (5 Gözlü)**  
*Tool Box for Mechanician (5 Trays)*

KOD CODE	ÖLÇÜ SIZE mm	□	TL/Ad.
8420 00 5063	195x420x210 <b>DOLU / FULL</b>	62	5.410,50

KOD CODE	İÇERİK CONTENTS	□
05881 50 015	<b>5 m Krom Şerit Metre</b> Chrom Case Steel, Measuring tapes	1
4785 19 6330	<b>6.3x30 Kısa Bits Tutucu Tornavida</b> Screwdriver, Magnetic Bit Holder (Short)	1
4800 00 8110	<b>10 'Lu Bits Takım</b> Bits Set 10 (Pcs) 25 mm	10
4320	<b>Opak Seri Yıldız Uçlu Tornavida</b> Screwdriver, Opak, Flat 4.5x80-6x100	2
4300	<b>Opak Seri Düz Uçlu Tornavida</b> Screwdriver, Opak, Phillips 3x80-4x100-5x125-6x150	4
4550 17 0135	<b>135mm Kontrol Kalem</b> Voltage Tester	1
2400 11 0240	<b>240mm Üniversal Fort Pense</b> Water Pump Pliers Universal	1
1113	<b>1/2" Lokma Anahtar</b> Socket Wrench 10-11-12-13-14-15-17-19-22-24-27-30-32	13
1513 06 4250	<b>1/2" Uzun Ara Kol</b> Extension Bar Long 250 mm	1
1513 06 4070	<b>1/2" Mafsal</b> Universal Joint 70 mm	1
1513 06 0032	<b>1/2" Cırcır Kol 32 Dişli</b> Ratchet Handle 250 mm	1
4900 00 3112	<b>12 'Li Allen Anahtar Takım 6 Köşe</b> Hex Key Wrench Set 2-2.5-3-3.5-4-5-6-7-8-9-10-12	12
0320	<b>Kısa Kombine Anahtar</b> Combination Wrench Short Pattern 8-9-10-11-12-13-14-17-19-22	10
3700 16 2160	<b>160mm Yan Keski Opak Seri</b> Side Cutting Nippers, Opak insulated	1
3020 12 2180	<b>180mm Kombine Pense Opak Seri</b> Combination Pliers, Opak Insulated	1
3220 13 2160	<b>160mm Düz Kargaburun Opak Seri</b> Nose Pliers, Flat, Opak Insulated	1

**8420 00 5046**
**Elektrikçi Takım Çantası (5 Gözlü)**  
*Tool Box for Electrician (5 Trays)*

KOD CODE	ÖLÇÜ SIZE mm	□	TL/Ad.
8420 00 5046	195x420x210 <b>DOLU / FULL</b>	45	6.177,50

KOD CODE	İÇERİK CONTENTS	□
05881 50 005	<b>5m Plastik Şerit Metre</b> Plastic Measuring Tape	1
4783 19 6120	<b>1000V İzoleli Manyetik Bits Tutucu Tornavida</b> Screwdriver, Magnetic Bit Holder Insulated 6.3x120	1
4800 00 8106	<b>6 'Lı Bits Takım</b> Bits Set (6 Pcs)	6
0600 01 1010	<b>10" Kurbağacık Anahtar</b> Adjustable Jaw Wrench	1
4140-4145	<b>1000V İzoleli Elektrikçi Düz, Yıldız Tornavida</b> Insulated Electrician type Flat Screwdriver, Phillips 1000V 4x100-5.5x125 - 4.5x80-6x100	4
4550 17 0135	<b>135mm Kontrol Kalem</b> Voltage Tester	1
4550 17 0190	<b>190mm Kontrol Kalem</b> Voltage Tester	1
4773	<b>1000V Süngüsü İzoleli Lokma Uçlu Tornavida</b> Nut Spinner, Electrician Blade Insulated 1000V 6-7-8-10-13	5
0340	<b>Cırcır Kombine Anahtar</b> Combination Wrench With Ratchet 8-10-12-13-17-19	6
4900 00 3110	<b>10 'Lu Allen Anahtar Takımı (mm)</b> Hex Key Wrench Set 10 pcs 2-2.5-3-4-5-6-7-8-9-10	10
4500-4520	<b>Klemens Tornavida</b> Screwdriver, Electronic 3x80-3x100-3x125-3x60-4x80	5
3700 16 6160	<b>1000V İzoleli Elektrikçi 160mm Yan Keski</b> Insulated Electrician Type Side Cutter 1000V	1
3020 12 6180	<b>1000V İzoleli Elektrikçi 180mm Kombine Pense</b> Insulated Electrician Type Combination Plier 1000V	1
3220 13 6160	<b>1000V İzoleli Elektrikçi 160mm Kargaburun Düz</b> Insulated Electrician Type Nose Plier 1000V	1

**8420 00 5028**
**Tesisatçı Takım Çantası (5 Gözlü)**  
*Tool Box for Plumbers (5 Trays)*

KOD CODE	ÖLÇÜ SIZE mm	□	TL/Ad.
8420 00 5028	195x420x210 <b>DOLU / FULL</b>	28	5.329,00

KOD CODE	İÇERİK CONTENTS	□
0600 01 1010	<b>10" Kurbağacık Anahtar</b> 10" Adjustable Wrench	1
0600 01 1012	<b>12" Kurbağacık Anahtar</b> 12" Adjustable Jaw Wrench PVC Insulated	1
2400 11 0240	<b>240 Üniversal Fort Pense</b> 240 Waterpump Pliers, Universal	1
2100 10 0012	<b>12" Stilson Boru Anahtarı</b> 12" Pipe Wrench, Stilson	1
4901 22 1270	<b>1/2" Sae Allen Anahtar</b> 1/2" Hex Key Wrench SAE	1
4300 17 6150	<b>Opak Seri Düz Uçlu Tornavida</b> Screwdriver, Opak, Slotted 6x150	1
4320 18 6100	<b>Opak Seri Yıldız Uçlu Tornavida</b> Screwdriver, Opak, Phillips 6x100	1
5800 25 0500	<b>500gr Çekiç</b> Machinist Hammer	1
5500 23 0200	<b>200mm Düz Keski</b> Flat Cold Chisel	1
3830 15 0250	<b>250mm Betoncu Kerpeten</b> Tower Pincers	1
4900 00 3112	<b>12 'Li Allen Anahtar Takımı (mm)</b> Hex Key Wrench Set 12 pcs 2-2.5-3-3.5-4-5-6-7-8-9-10-12	12
0588 15 0015	<b>5m Krom Şerit Metre</b> Chrom Case Steel Measuring Tape	1
2201 10 0010	<b>1" Maşalı Boru Anahtarı</b> 1" Pipe Wrench	1
3700 16 2160	<b>160mm Yan Keski Opak Seri</b> Side Cutting Nippers, Opak insulated	1
3020 12 2180	<b>180mm Kombine Pense Opak Seri</b> Combination Pliers, Opak Insulated	1
3220 13 2160	<b>160mm Düz Kargaburun Opak Seri</b> Nose Pliers, Flat, Opak Insulated	1

**8440**

Plastik Takım Çantaları  
Plastic Tool Boxes



KOD CODE	inch	ÖLÇÜ SIZE mm	g	TL/Ad.
8440 33 1016	16"	413x212x186	1207	4 267,50
8440 33 1019	19"	480x267x242	1922	4 374,50
8440 33 1022	22"	564x310x310	2870	4 613,50

**8445**

Tekerlekli Plastik Takım Çantası  
Plastic Mobile Tool Chest



KOD CODE	inch	ÖLÇÜ SIZE mm	g	TL/Ad.
8445 33 1028	28"	380x595x420	5900	1 1.478,75

**8705 00 6113**

Hobby Set Oto Tipi (13 Parça)  
Hobby Set Auto Type (13 pcs)



KOD CODE	İÇERİK CONTENTS	TL/Ad.
0100	<b>İki Ağız Anahtar (Kısa Boy)</b> Duble Ended Open Jaw Wrench Short Pattern 8x9-10x11-12x13-14x15-16x17-18x19	6
1841	<b>21 mm Kovan Anahtar Bir Ağız ve Mil</b> Single Ended Tubular Socket Wench	1
2400	<b>240 mm Üniversal Fort Pense</b> Waterpump Pliers Universal	1
3020	<b>160 mm Kombine Pense Opak Seri</b> Combination Pliers	1
4240	<b>Değişken Uçlu Tornavida Takımı</b> Screwdriver Set Reversible 4.5x80 - 6x80	2
5800	<b>200 gr Tesviyeci Çekiç / Machinist Hammer</b>	1
6350	<b>300 mm Levye Oluklu / Tyre Lever Straight</b>	1

**8790 00 8106**

Bakım Onarım Seti (5 Parça)  
Maintenance Set (5 Pcs)



KOD CODE	İÇERİK CONTENTS	TL/Ad.
3020 12 3160	<b>160 mm Kombine Pense Kraft Seri</b> Combination Pliers	1
3220 13 3160	<b>160 mm Kargaburun Düz Uçlu Kraft Seri</b> Nose Pliers Flat	1
3700 16 3140	<b>140 mm Yan Keski Kraft Seri</b> Side Cutting Pliers	1
4100 17 5100	<b>5x100 Kraft Seri Düz Uçlu Tornavida</b> Screwdriver Kraft, Flat	1
4120 18 4580	<b>4.5x80 Kraft Seri Yıldız Uçlu Tornavida</b> Screwdriver Kraft, Phillips	1

**8793 00 1014**
**Bakım Seti (14 Parça)**  
*Maintenance Set (14 Pcs)*

KOD CODE	İÇERİK CONTENTS	☐	TL/Ad.
0100	<b>İki Ağız Anahtar (Kısa Boy)</b> Duble Ended Open Jaw Wrench Short Pattern 6x7-8x9-10x11-12x13-14x15-16x17-18x19-20x22	8	
3220 13 2160	<b>160 mm Kargaburun Düz Uçlu Opak Seri</b> Nose Pliers Flat	1	
3700 16 2140	<b>140 mm Yan Keski Opak Seri</b> Side Cutting Pliers	1	1.071,00
4300	<b>4x100-6x100 Opak Seri Düz Uçlu Tornavida</b> Screwdriver Kraft, Flat	2	
4320	<b>4.5x80-6x100 Opak Seri Yıldız Uçlu Tornavida</b> Screwdriver Kraft, Phillips	2	

**8786 00 1003**
**Doğada Set (3 Parça)**  
*Outdoor Set (3 Pcs)*

 İZELTAS USTA İŞİ  
SOHBETLER

KOD CODE	İÇERİK CONTENTS	☐	TL/Ad.
6710 27 0230	Bağ Makası Lüks / Pruning Shears	1	
6735 27 0300	Dal Budama Testeresi / Pruning Saw	1	1.469,25
6410 25 0800	Nacak / Hatchet	1	

**8779 00 8741**
**Motosiklet Bakım Seti**  
*Biker Set (42 Pcs)*

KOD CODE	İÇERİK CONTENTS	☐	TL/Ad.
0100 01 0809	<b>İki Ağız Anahtar Kısa Boy 08x09</b> Double Ended Open Jaw Wrench Short Pattern mm	1	
0100 01 1011	<b>İki Ağız Anahtar Kısa Boy 10x11</b> Double Ended Open Jaw Wrench Short Pattern mm	1	
0100 01 1213	<b>İki Ağız Anahtar Kısa Boy 12x13</b> Double Ended Open Jaw Wrench Short Pattern mm	1	
0100 01 1415	<b>İki Ağız Anahtar Kısa Boy 14x15</b> Double Ended Open Jaw Wrench Short Pattern mm	1	
0100 01 1617	<b>İki Ağız Anahtar Kısa Boy 16x17</b> Double Ended Open Jaw Wrench Short Pattern mm	1	
0600 01 1008	<b>Kurbağacık Anahtar 8"</b> Adjustable Wrench 8"	1	
1107 06 0006	<b>1/4" Altı Köşe 6 mm Lokma Anahtar</b> Socket Wrench 6 Point (6mm)	1	
1107 06 0008	<b>1/4" Altı Köşe 8 mm Lokma Anahtar</b> Socket Wrench 6 Point (8mm)	1	
1107 06 0010	<b>1/4" Altı Köşe 10 mm Lokma Anahtar</b> Socket Wrench 6 Point (10mm)	1	
1107 06 0011	<b>1/4" Altı Köşe 11 mm Lokma Anahtar</b> Socket Wrench 6 Point (11mm)	1	1.823,50
1107 06 0012	<b>1/4" Altı Köşe 12 mm Lokma Anahtar</b> Socket Wrench 6 Point (12mm)	1	
1107 06 0013	<b>1/4" Altı Köşe 13 mm Lokma Anahtar</b> Socket Wrench 6 Point (13mm)	1	
1107 06 5010	<b>1/4" Bits Tutucu Lokma Mıknatıslı</b> Bit Holder Socket	1	
4240 00 7102	<b>Değişken Uçlu Tornavida Takımı</b> Screwdriver Set Reversible	2	
4800 00 8106	<b>6'lı Bits Set (25 mm)</b> Bit Set 6 Pcs	6	
4900 00 3110	<b>Allen Anahtar Takımı 10 Parça</b> Hex Set Wrench Set (10 Pcs)	10	
4910 00 7108	<b>Torx Allen Anahtar Takımı 8 Parça</b> Torx Key Wrench Set (8 Pcs)	8	
1507 06 0050	<b>1/4" Ara Kol 50 mm</b> Extension Bar 50 mm	1	
1507 06 2140	<b>1/4" Cırcır Kolu 140 mm</b> Ratchet Wrench 140 mm	1	
1507 06 4080	<b>1/4" Derin Tornavida Adaptörü</b> Spindle Handle	1	

**Sırt Takım Çantası**

- Su geçirmez, sağlam, dayanıklı ve uzun ömürlü, 600x600 imperteks kumaş
- Koruma sağlayıcı güçlendirilmiş sağlam plastik taban
- Maksimum düzeni sağlayan reflektörlü ön ve iç cepler
- Laptop bölmesi, sık kullanılan el aletleri için cepli çıkarılabilir ayraç
- Yumuşak pedli sırt desteği
- Yan mataralıklar

**Tool Backpack**

- Waterproof, solid, resistant and long-lasting 600X600 impertex fabric
- Protection provider, reinforced, solid plastic base
- Reflective front and interior pockets for maximum organization
- Laptop compartment, removable divider with pockets for frequently used tools
- Back support with soft pad
- Side bottle pockets

KOD/CODE	Ölçü / SIZE (mm)	G	FIYAT TL/Ad.
14000 004136	700x280x450	1385	935,25

**14000 004133**
**Büyük Boy Bez Takım Çantası**  
*Large Tool Bag*

**Büyük Boy Bez Takım Çantası**

- Su geçirmez, sağlam, dayanıklı ve uzun ömürlü, 600x600 imperteks kumaş
- Koruma sağlayıcı güçlendirilmiş sağlam plastik taban
- Maksimum düzeni sağlayan reflektörlü ön cepler, çoklu arka ve iç cepler
- Özel el aleti bölmeli, geniş iç alan
- Ayarlanabilir omuz askısı ile kolay taşıma

**Large Tool Bag**

- Waterproof, solid, resistant and long-lasting 600X600 impertex fabric
- Protection provider, reinforced, solid plastic base
- Reflective front pockets with multiple back and interior pockets for maximum organization
- Wide interior space with special tool compartment
- Easy carrying with adjustable shoulder strap



KOD/CODE	Ölçü / SIZE (mm)	G	FİYAT TL/Ad.
14000 004133	250x350x480	1220	854,00

**14000 004135**
**Orta Boy Bez Takım Çantası**  
*Medium Tool Bag*

**Orta Boy Bez Takım Çantası**

- Su geçirmez, sağlam, dayanıklı ve uzun ömürlü, 600x600 imperteks kumaş
- Koruma sağlayıcı güçlendirilmiş sağlam plastik taban
- Maksimum düzeni sağlayan reflektörlü ön cepler, çoklu arka ve iç cepler
- Özel el aleti bölmeli, geniş iç alan
- Ayarlanabilir omuz askısı ile kolay taşıma

**Medium Tool Bag**

- Waterproof, solid, resistant and long-lasting 600X600 impertex fabric
- Protection provider, reinforced, solid plastic base
- Reflective front pockets with multiple back and interior pockets for maximum organization
- Wide interior space with special tool compartment
- Easy carrying with adjustable shoulder strap



KOD/CODE	Ölçü / SIZE (mm)	G	FİYAT TL/Ad.
14000 004135	290x230x360	870	814,25

**Küçük Boy Bez Takım Çantası**  
*Small Tool Bag***YENİ  
NEW****Küçük Boy Bez Takım Çantası**

- Su geçirmez, sağlam, dayanıklı ve uzun ömürlü, 600x600 imperteks kumaş
- Kuvvetlendirilmiş taban
- Fermuarlı fileli ön cep
- Düğmeli arka cep
- Özel el aleti bölmeli, geniş iç alan
- Rahat taşıma için deri elcik
- Yan reflektörler
- Özel metal fermuar başlığı

**Small Tool Bag**

- Waterproof, solid, resistant and long-lasting 600X600 impertex fabric
- Reinforced base
- Zippered front pocket
- Buttoned back pocket
- Wide interior space with special tool compartment
- Leather grips for comfortable carrying
- Side reflectors



KOD/CODE	Ölçü / SIZE (mm)	G	FİYAT TL/Ad.
14000 004134	120x230x300	390	527,75

**14000 004137****Bel Takım Çantası**  
*Handyman Tool Belt***YENİ  
NEW****Bel Takım Çantası**

- Su geçirmez, sağlam, dayanıklı ve uzun ömürlü, 600x600 imperteks kumaş
- 3 farklı boyda cebi ve 8 el aleti askısı ile maksimum düzeni sağlayan kullanışlı model
- Reflektörlü ön cep
- Ayarlanabilir ve kullanışlı sağlam kemer

**Handyman Tool Belt**

- Waterproof, solid, resistant and long-lasting 600X600 impertex fabric
- Maximum organization providing functional model with 3 different sized pockets and 8 tool hangers
- Reflective front pocket
- Adjustable and functional solid belt

KOD/CODE	Ölçü / SIZE (mm)	G	FİYAT TL/Ad.
14000 004137	424x594x851	290	319,25



**ŞABLON  
BILLET**



**FİNAL ÜRÜN  
FINAL PRODUCT**





**İZELTAS®**

# ANAHTARLAR

## WRENCHES

WRENCHES

ANAHTARLAR

İki Ağız Anahtarlar  
Open Jaw Wrenches

Kombine Anahtarlar  
Combination Wrenches

Yıldız Anahtarlar  
Ring Wrenches

Çakma Anahtarlar  
Slugging Wrenches

Kurbağacık Anahtarlar  
Adjustable Wrenches

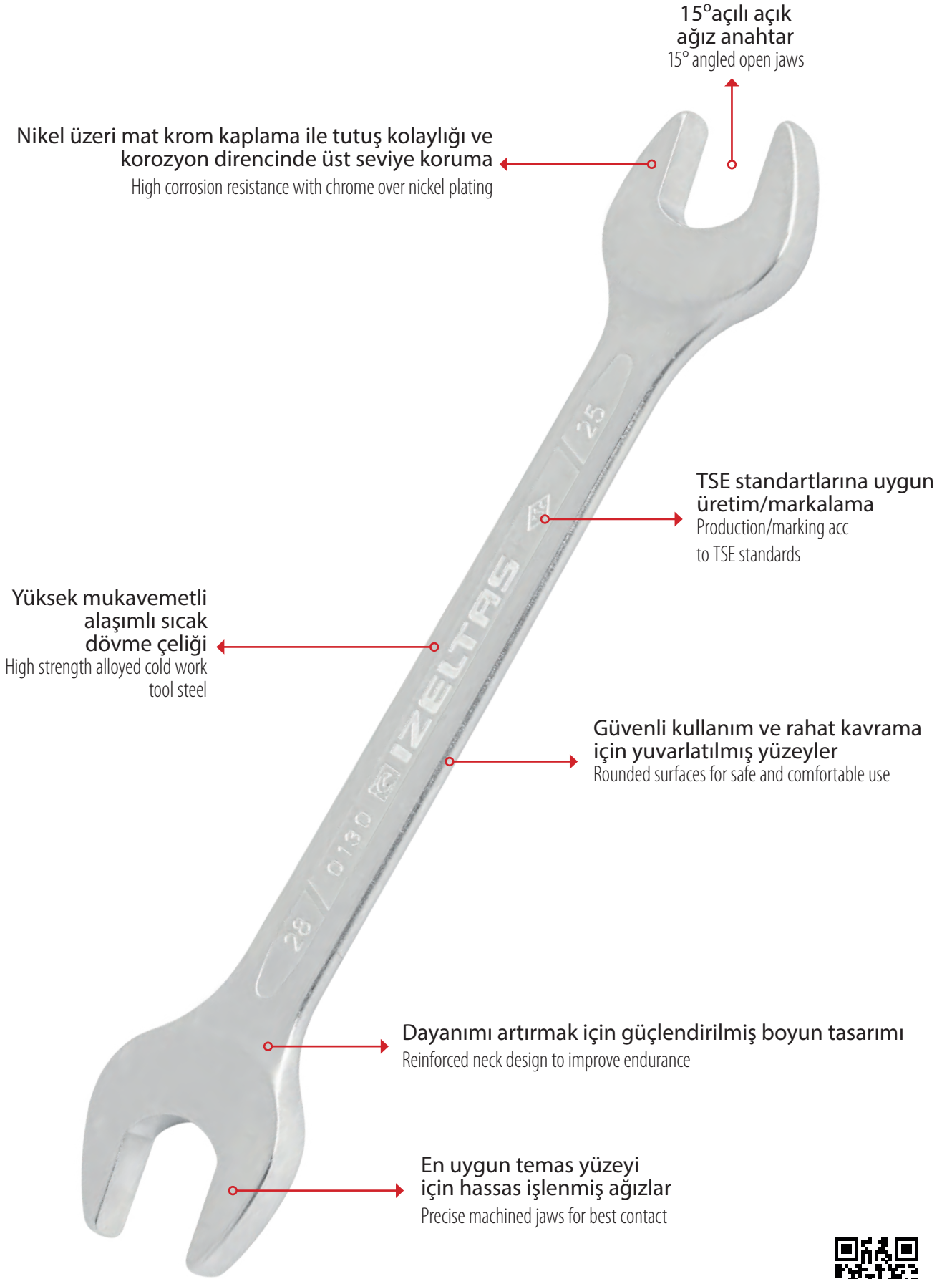

İZELTAS YOUTUBE

**İKİ AĞIZ ANAHTAR / DOUBLE ENDED OPEN JAW WRENCH**

## 0100

### İki Ağız Anahtar Kısa Boy (mm)

Double Ended Open Jaw Wrench Short Pattern (mm)



TS 81-6  
DIN 895



İZELTAS YOUTUBE

Krom vanadyum, Krom kaplı  
Chrom vanadium, Chrom plated

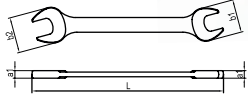

KOD CODE	mm	L mm	a1 mm	b1 mm	b2 mm	g	TL/Ad.	
0100 01 0405	4x5	97	3.5	11	12.5	15	10	30,75
0100 01 0607	6x7	97	3.5	14	16	18	10	31,50
0100 01 0809	8x9	108	4	18	20	30	10	32,25
0100 01 0810	8x10	117	4.5	18	22	33	10	35,50
0100 01 1011	10x11	120	4.6	22	24	41	10	35,25
0100 01 1012	10x12	120	4.6	22	26	35	10	35,25
0100 01 1013	10x13	120	4.6	22	28	38	10	37,75
0100 01 1213	12x13	133	5.2	26	28	57	10	38,75
0100 01 1214	12x14	147	5.2	26	30	59	10	38,75
0100 01 1314	13x14	147	5.2	28	30	66	10	38,75
0100 01 1415	14x15	147	5.8	30	32	78	10	44,75
0100 01 1317	13x17	162	6.2	28	36	80	10	50,75
0100 01 1417	14x17	162	6.2	30	36	90	10	52,25
0100 01 1617	16x17	162	6.2	34	36	109	10	52,25
0100 01 1719	17x19	178	7	36	40	143	10	56,00
0100 01 1819	18x19	178	7	38	40	144	10	56,00
0100 01 1922	19x22	195	7.4	40	46	175	10	63,00
0100 01 2022	20x22	195	7.4	42	46	196	10	65,25
0100 01 2123	21x23	213	7.7	44	48	230	10	68,50
0100 01 2224	22x24	213	8	46	50	239	10	71,50
0100 01 2426	24x26	232	8.2	50	54	297	10	73,50
0100 01 2427	24x27	232	8.2	50	56	296	10	73,50
0100 01 2528	25x28	248	8.6	52	57.5	366	10	91,25
0100 01 2732	27x32	265	9	56	66	415	10	108,75
0100 01 3032	30x32	265	9	62	66	465	10	108,75

### ÖZEL SERİLER (adet ve termin süresi isteyiniz) SPECIAL SERIES (ask for quantity and delivery terms)

0100 01 0608	6x8	97	3.5	14	18	20	10	35,00
0100 01 0708	7x8	108	3.5	16	18	20	10	35,00
0100 01 0709	7x9	108	4	16	20	25	10	35,00
0100 01 0910	9x10	117	4.6	20	22	30	10	36,50
0100 01 0911	9x11	120	4.6	20	24	30	10	38,75
0100 01 1014	10x14	120	5.2	22	30	50	10	44,00
0100 01 1113	11x13	133	5.2	26	28	50	10	38,75
0100 01 1114	11x14	133	5.2	26	28	50	10	45,00
0100 01 1315	13x15	147	5.2	28	30	65	10	44,75
0100 01 1722	17x22	195	7.4	36	46	160	10	69,50
0100 01 1820	18x20	178	7	38	40	125	10	69,50
0100 01 1822	18x22	195	7.4	40	46	160	10	69,50
0100 01 1924	19x24	213	7.7	40	50	200	10	72,25
0100 01 2226	22x26	232	8	46	54	250	10	79,75
0100 01 2227	22x27	232	8.2	46	56	260	10	79,75
0100 01 2430	24x30	265	9	50	62	370	10	115,00
0100 01 2730	27x30	265	9	56	62	380	10	115,00

## 0100

### İki Ağız Anahtar Takımı Kısa Boy (mm)

Double Ended Open Jaw Wrench  
Short Pattern Set (mm)



KOD CODE	İÇERİK CONTENTS	g	TL/Ad.	
0100 00 2108	6x7 - 8x9 - 10x11 12x13 - 14x15 - 16x17 18x19 - 20x22	736	8	356,00
0100 00 2112	6x7 - 8x9 - 10x11 12x13 - 14x15 - 16x17 18x19 - 20x22 - 21x23 24x26 - 25x28 - 30x32	2110	12	698,00

**İki Ağzı Anahtar Uzun Boy (mm)**
*Double Ended Open Jaw Wrench Long Pattern (mm)*

  
 TS ISO 10102  
 DIN 3110

 Krom vanadyum, Krom kaplı  
 Chrom vanadium, Chrom plated

KOD CODE	mm	L mm	a1 mm	b1 mm	b2 mm	g	TL/Ad.	
0130 01 0607	6x7	125	3.5	14	16	24	10	40,00
0130 01 0608	6x8	125	3.5	14	18	20	10	41,50
0130 01 0809	8x9	140	4	18	20	35	10	41,50
0130 01 0810	8x10	140	4	18	22	36	10	41,50
0130 01 1011	10x11	155	4.5	22	24	47	10	45,75
0130 01 1012	10x12	162	4.7	22	26	57	10	45,75
0130 01 1013	10x13	162	4.7	22	28	61	10	45,75
0130 01 1014	10x14	162	4.7	22	28	65	10	45,75
0130 01 1113	11x13	172	5	26	28	70	10	45,75
0130 01 1114	11x14	172	5	26	30	65	10	45,75
0130 01 1213	12x13	172	5	26	28	67	10	48,25
0130 01 1214	12x14	172	5	26	30	65	10	48,25
0130 01 1314	13x14	188	5.5	28	30	85	10	48,25
0130 01 1315	13x15	188	5.5	30	32	93	10	48,25
0130 01 1415	14x15	188	5.5	30	32	91	10	56,00
0130 01 1317	13x17	205	6.2	28	36	111	10	61,25
0130 01 1417	14x17	205	6.2	30	36	106	10	61,25
0130 01 1617	16x17	205	6.2	34	36	120	10	61,75
0130 01 1618	16x18	220	7	36	40	165	10	66,00
0130 01 1719	17x19	220	7	36	40	160	10	66,00
0130 01 1819	18x19	220	7	38	40	161	10	66,00
0130 01 1921	19x21	235	7.5	40	46	195	5	76,75
0130 01 1922	19x22	235	7.5	40	46	195	5	76,75
0130 01 2022	20x22	235	7.5	42	46	195	5	76,75
0130 01 1924	19x24	248	8.3	40	50	235	5	77,25
0130 01 2123	21x23	248	8.3	44	48	235	5	78,50
0130 01 2224	22x24	248	8.3	46	50	235	5	83,25
0130 01 2426	24x26	265	8.8	50	54	300	5	95,25
0130 01 2427	24x27	265	8.8	50	56	300	5	95,25
0130 01 2430	24x30	282	9.3	50	61.5	380	5	106,50
0130 01 2528	25x28	282	9.3	52	57.5	390	5	106,50
0130 01 2729	27x29	300	9.8	56	59	400	5	133,00
0130 01 2730	27x30	300	9.8	56	59	440	5	133,00
0130 01 2732	27x32	300	9.8	56	65.5	460	5	133,00
0130 01 3032	30x32	300	9.8	61.5	65.5	480	5	133,00
0130 01 3036	30x36	325	10.4	61.5	76	645	5	252,25
0130 01 3236	32x36	325	10.4	65.5	76	680	5	252,25
0130 01 3436	34x36	330	10.4	71	76	690	5	252,25
0130 01 3641	36x41	360	12	76	87	955	5	391,75
0130 01 4146	41x46	400	12.5	87	98	1300	5	604,00
0130 01 4650	46x50	450	13	98	107	1635	5	669,75

**ÖZEL SERİLER (adet ve termin süresi isteyiniz)**
**SPECIAL SERIES (ask for quantity and delivery terms)**

0130 01 0555	5x5.5	125	3.5	14	16	15	10	31,50
0130 01 0708	7x8	135	3.5	16	18	20	10	41,50
0130 01 0709	7x9	140	4	16	20	30	10	41,50
0130 01 0910	9x10	140	4	18	22	45	10	45,75
0130 01 0911	9x11	155	4.5	22	24	45	10	45,75
0130 01 1722	17x22	235	7.5	36	46	190	5	76,75
0130 01 1724	17x24	248	8.3	36	50	240	5	77,25
0130 01 2227	22x27	265	8.8	46	56	300	5	95,25

**0130**
**İki Ağzı Anahtar Takımı Uzun Boy (mm)**
*Double Ended Open Jaw Wrench  
Long Pattern Set (mm)*

KOD CODE	İÇERİK CONTENTS	g	TL/Ad.	
0130 00 2108	6x7 - 8x9 - 10x11 - 12x13 14x15 - 16x17 - 18x19 20x22	815	8	436,00
0130 00 2112	6x7 - 8x9 - 10x11 12x13 - 14x15 - 16x17 18x19 - 20x22 - 21x23 24x26 - 25x28 - 27x32	2315	12	849,25

0161

İki Ağız Anahtar Uzun Boy (SAE)  
Double Ended Open Jaw Wrench Long Pattern (SAE)

TSEK



Krom vanadyum, Krom kaplı  
Chrom vanadium, Chrom plated

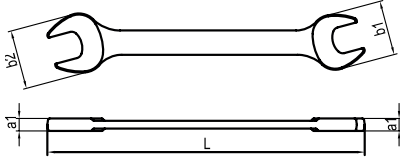

0161

İki Ağız Anahtar Takımı Uzun Boy (SAE)  
Double Ended Open Jaw Wrench  
Long Pattern Set (SAE)

TSEK

KOD CODE	inch	L mm	a1 mm	b1 mm	b2 mm	g	TL/Ad.
0161 01 0608	1/4"x5/16"	125	3.5	14	18	18	49,50
0161 01 0809	5/16"x3/8"	140	4	18	20	30	49,50
0161 01 0810	5/16"x11/32"	140	4	18	20	30	49,50
0161 01 0811	5/16"x7/16"	140	4	18	22	30	49,50
0161 01 0911	3/8"x7/16"	155	4.5	22	24	35	55,00
0161 01 1112	7/16"x1/2"	172	5	26	28	40	55,00
0161 01 1214	1/2"x9/16"	172	5	26	30	65	57,75
0161 01 1416	9/16"x5/8"	188	5.5	30	32	85	67,25
0161 01 1417	9/16"x11/16"	205	6.2	30	36	110	73,25
0161 01 1517	19/32"x11/16"	205	6.2	34	36	115	74,00
0161 01 1619	5/8"x3/4"	220	7	36	40	150	79,25
0161 01 1920	3/4"x25/32"	220	7	38	40	160	79,25
0161 01 2021	25/32"x13/16"	235	7.5	40	46	195	92,00
0161 01 1922	3/4"x7/8"	235	7.5	40	46	195	92,00
0161 01 2122	13/16"x7/8"	248	8.3	44	48	235	93,75
0161 01 2325	15/16"x1"	265	8.8	50	54	300	110,50
0161 01 2328	15/16"x1 1/8"	265	8.8	50	56	300	111,75
0161 01 2628	1 1/16"x1 1/8"	300	9.8	56	59.5	460	160,50
0161 01 2631	1 1/16"x1 1/4"	300	9.8	56	65.5	460	169,50
0161 01 2833	1 1/8"x1 5/16"	300	9.8	56	65.5	460	169,50

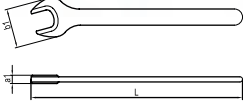

KOD CODE	İÇERİK CONTENTS	g	TL/Ad.
0161 00 2108	1/4"x5/16" - 5/16"x3/8" 7/16"x1/2" - 9/16"x5/8" - 19/32"x11/16" 3/4"x25/32" - 13/16"x7/8" - 15/16"x1"	1090	8 578,75
0161 00 2112	1/4"x5/16" - 5/16"x3/8" - 3/8"x7/16" 7/16"x1/2" - 1/2"x9/16" - 9/16"x5/8" 19/32"x11/16" - 3/4"x25/32" - 13/16"x7/8" 15/16"x1" - 1 1/16"x1 1/4" 1 1/8"x1 5/16"	2165	12 1,030,50

**Bir Ağız Taçlı Anahtar (mm)**
*Single Ended Open Jaw Wrench (mm)*

**Krom vanadyum**  
*Chrom vanadium*

KOD CODE	mm	L mm	a1 mm	b1 mm	g	TL/Ad.
0250 01 0030	30	260	10.5	60	250	1 183,75
0250 01 0036	36	300	10.5	74.5	370	1 232,00
0250 01 0041	41	345	12.2	85.5	550	1 302,75
0250 01 0046	46	390	14	96.5	750	1 326,00
0250 01 0050	50	423	15.2	105	1000	1 407,00
0250 01 0055	55	455	16.5	113.5	1300	1 545,25
0250 01 0060	60	490	17.6	121	1600	1 698,25
0250 01 0065	65	524	19	130	1980	1 851,00

**ÖZEL SERİLER (adet ve termin süresi isteyiniz)**  
**SPECIAL SERIES (ask for quantity and delivery terms)**

0250 01 0021	21	185	8	42.4	95	1	----
0250 01 0022	22	195	8	44.4	110	1	----
0250 01 0023	23	195	8	46.3	115	1	----
0250 01 0024	24	215	9	48.3	150	1	----
0250 01 0025	25	215	9	50.3	155	1	----
0250 01 0027	27	240	9.5	54.3	200	1	----
0250 01 0032	32	274	11	63	300	1	----
0250 01 0034	34	274	11	68	320	1	----
0250 01 0038	38	300	10.5	76.8	400	1	----
0250 01 0070	70	564	20.8	140	2480	1	----
0250 01 0075	75	608	21.8	151	3100	1	----

**Süper İzole Çatal Bir Ağız Anahtar (mm)**
*Single Ended Open Jaw Wrench Super Insulated (mm)*

 IEC 60900  
 ⚡ 1000 V

**Krom vanadyum, Krom kaplı, Kalın PVC izoleli**  
*Chrom vanadium, Chrom plated, Triple PVC insulated*

KOD CODE	mm	L mm	g	TL/Ad.
0255 01 0010	10	110	40	107,50
0255 01 0011	11	120	45	113,50
0255 01 0012	12	130	50	118,75
0255 01 0013	13	140	60	127,75
0255 01 0014	14	155	75	132,50
0255 01 0017	17	170	100	162,50
0255 01 0019	19	185	150	190,75
0255 01 0022	22	200	200	256,50
0255 01 0024	24	220	280	314,00

**Montaj Anahtar (mm)**
*Speed Wrench (mm)*

IZELTAS YOUTUBE

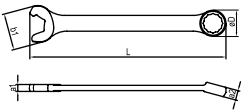
**Krom vanadyum, Krom kaplı**  
*Chrom vanadium, Chrom plated*

KOD CODE	mm	L mm	a1 mm	a2 mm	b1 mm	σD mm	g	TL/Ad.
0325 02 0010	10	135	4.3	6.9	22	15.5	35	10 70,50
0325 02 0013	13	165	5.2	7.9	28	19.5	45	10 78,75
0325 02 0017	17	205	6.4	9.8	36	25.5	110	10 104,25
0325 02 0019	19	225	7	11	40	28.5	155	10 122,00
0325 02 0020	20	230	7.2	11.4	42	30	180	10 124,25
0325 02 0021	21	242	7.4	12	44	31.5	180	10 144,50
0325 02 0022	22	250	8.2	12.6	46	33	245	10 165,50

**%100 Daha Hızlı**

Yeni tasarlanan montaj anahtarları, 2 kat hızlıncırcır mekanizması mantığına dayanan çalışma prensibinden alır. Kullanım sırasında, montaj anahtarını civatadan ayırmadan döndürme kolaylığı kullanım hızını artırırken, civata köşelerine sağlam tutunan anahtar profili güvenli ve kaydırmaz kullanım sağlar.

**Uzun Ömür**

Bu yeni montaj anahtarları profili, civata ve somunlar ile köşelerinden değil düz yüzeyleri üzerinden temas ederek düzenli tork iletimini sağlarken, gerilimin artmasını da engelleyerek anahtar ömrünün uzamasını sağlar.

• Anahtar civatadan ayırmadan hızlı kullanım.

• Güvenli tork iletimi ve uzun ömür.

**100% Faster**

The 100% new design speed wrench takes the 2-fold speed from the operating principle based on the ratchet mechanism logic. While in use, the ease of rotation without detaching the mounting wrench from the bolt increases the speed of use and the profile that firmly secured to the corners ensures safe and non-slip use

**Long Life**

This new mounting wrench profile by contacting bolts and nuts, not on corners, but on their flat surfaces, allows regular torx transmission, prevents the increase in surface tension and provides longer life.

• Quick use without detaching the wrench from the bolt.

• Safe torx transmission and long life.

**Kombine Anahtar Kısa Boy (mm)**  
*Combination Wrench Short Pattern (mm)*

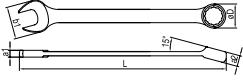
 TS 3794  
 TS ISO 7738 Form A  
 DIN 3113

 Krom vanadyum, Krom kaplı  
 Chrom vanadium, Chrom plated

**0320**
**Kombine Anahtar Takımı Kısa Boy (mm)**  
*Combination Wrench Short Pattern Set (mm)*

KOD CODE	mm	L mm	a1 mm	a2 mm	b1 mm	øD mm	g	TL/ Ad.
0320 02 0005	5	90	3.4	5.1	14	10	15	10 40,00
0320 02 0055	5.5	90	3.4	5.1	14	10	15	10 40,00
0320 02 0006	6	100	3.4	5.1	14	10	15	10 41,50
0320 02 0007	7	110	3.6	5.5	16	11	20	10 44,00
0320 02 0008	8	120	3.8	5.9	18	13	25	10 48,00
0320 02 0009	9	130	4	6.3	20	14	30	10 49,00
0320 02 0010	10	140	4.3	6.9	22	15.5	40	10 55,25
0320 02 0011	11	150	4.5	7.3	24	17	45	10 56,75
0320 02 0012	12	160	4.9	7.7	26	18.5	55	10 60,50
0320 02 0013	13	170	5.2	7.9	28	19.5	60	10 61,75
0320 02 0014	14	180	5.5	8.7	30	21.5	75	10 67,00
0320 02 0015	15	190	5.8	9.1	32	22.5	90	10 71,50
0320 02 0016	16	200	6.1	9.6	34	24	105	10 76,75
0320 02 0017	17	210	6.4	9.8	36	25.5	120	10 82,00
0320 02 0018	18	220	6.8	10.4	38	27	145	10 91,25
0320 02 0019	19	232	7	11	40	28.5	170	10 96,00
0320 02 0020	20	240	7.2	11.4	42	30	195	10 98,00
0320 02 0021	21	250	7.4	12	44	31.5	190	10 113,50
0320 02 0022	22	260	8.2	12.6	46	33	275	10 129,50
0320 02 0023	23	270	8.3	13	48	35	255	5 129,50
0320 02 0024	24	280	8.5	13.6	50	36.5	320	5 158,75
0320 02 0025	25	290	8.8	14	52	39	320	5 158,75
0320 02 0026	26	300	9	14.8	54	41	400	5 187,00
0320 02 0027	27	310	9.3	15	56	41.5	400	5 187,00
0320 02 0028	28	320	9.4	15.4	57.5	42.5	380	5 187,00
0320 02 0029	29	330	10	15.6	59	43.5	510	5 214,00
0320 02 0030	30	340	10.3	16	61.5	44	505	5 214,00
0320 02 0032	32	370	10.5	16.2	65.5	47	560	5 225,00
0320 02 0034	34	400	10.7	16.8	71	50	675	5 235,00

KOD CODE	İÇERİK CONTENTS	g	TL/ Ad.
0320 00 2108	6 - 7 - 8 - 9 - 10 - 13 - 17 - 19	475	8 477,50
0320 00 2112	8 - 9 - 10 - 11 - 12 - 13 - 14 15 - 16 - 17 - 19 - 22	1190	12 854,00
0320 00 2117	6 - 7 - 8 - 9 - 10 - 11 - 12 - 13 - 14 15 - 16 - 17 - 18 - 19 - 20 - 21 - 22	1760	17 1.242,25
0320 00 2121	6 - 7 - 8 - 9 - 10 - 11 - 12 - 13 - 14 15 - 16 - 17 - 18 - 19 - 20 - 21 - 22 24 - 27 - 30 - 32	3650	21 2.027,00

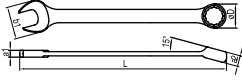
**Kombine Anahtar Uzun Boy (mm)**  
*Combination Wrench, Long Pattern (mm)*

 TS 3794  
 TS ISO 7738 Form A  
 DIN 3113

 Krom vanadyum, Krom kaplı  
*Chrom vanadium, Chrom plated*

KOD CODE	mm	L mm	a1 mm	a2 mm	b1 mm	ØD mm	g	TL/Ad.	
0330 02 0005	5	95	3.2	5.2	12.5	9	20	10	46,25
0330 02 0055	5.5	95	3.2	5.2	12.5	9	20	10	46,25
0330 02 0006	6	105	3.8	5.6	14	10.5	20	10	46,25
0330 02 0007	7	117	4	6.1	16	12	20	10	46,25
0330 02 0008	8	130	4.2	6.6	18	13.5	30	10	54,00
0330 02 0009	9	141	4.5	7	20	15	40	10	54,75
0330 02 0010	10	154	4.7	7.6	22	16	50	10	60,50
0330 02 0011	11	166	5	8.2	24	17.5	60	10	64,00
0330 02 0012	12	178	5.2	8.7	26	19	70	10	64,00
0330 02 0013	13	190	5.6	9.2	28	20.5	80	10	71,75
0330 02 0014	14	203	5.8	9.7	30	22	100	10	74,50
0330 02 0015	15	215	6.4	10.1	32	23.5	115	10	79,75
0330 02 0016	16	227	6.4	10.8	34	25	135	10	80,50
0330 02 0017	17	239	6.6	11.4	36	26.5	160	10	91,25
0330 02 0018	18	250	7	12	38	28	186	10	98,50
0330 02 0019	19	263	7.3	12.7	40	29.5	205	10	107,00
0330 02 0020	20	275	7.7	13.2	42	31	235	10	113,75
0330 02 0021	21	288	8.1	13.3	44	31.5	260	10	121,00
0330 02 0022	22	300	8.5	13.7	46	34	300	10	144,25
0330 02 0023	23	315	8.8	14.2	48	35.5	300	5	176,00
0330 02 0024	24	330	9	14.2	50	37	390	5	176,00
0330 02 0025	25	340	9.3	14.7	52	38.5	380	5	176,00
0330 02 0026	26	350	9.7	14.7	54	40	475	5	207,25
0330 02 0027	27	360	10	15.2	56	41	475	5	207,25
0330 02 0028	28	370	10.4	15.7	57.5	43	475	5	207,25
0330 02 0029	29	390	10.8	16.2	59	44	610	5	207,25
0330 02 0030	30	410	11.2	16.6	61.5	45	610	5	238,00
0330 02 0032	32	420	11.5	17.1	65.5	48	755	5	249,50
0330 02 0034	34	430	11.8	17.4	71	50.5	735	5	254,50
0330 02 0036	36	440	12.2	17.7	76	53	1000	5	288,25
0330 02 0038	38	450	12.5	18.7	80	56	1000	5	295,00
0330 02 0041	41	480	13.5	19.7	87	61	1240	5	335,75
0330 02 0046	46	505	14.7	20.7	95	67.5	1635	1	456,00
0330 02 0050	50	540	15.9	22.7	104	73.5	2100	1	618,25

**0330**
**Kombine Anahtar Takımı Uzun Boy (mm)**  
*Combination Wrench Long Pattern Set (mm)*

KOD CODE	İÇERİK CONTENTS	g	TL/Ad.	
0330 00 2108	6 - 7 - 8 - 9 - 10 - 13 17 - 19	665	8	531,75
0330 00 2112	8 - 9 - 10 - 11 - 12 13 - 14 - 15 - 16 17 - 19 - 22	1780	12	946,25
0330 00 2117	6 - 7 - 8 - 9 - 10 11 - 12 - 13 - 14 - 15 16 - 17 - 18 - 19 20 - 21 - 22	2170	17	1.372,00
0330 00 2121	6 - 7 - 8 - 9 - 10 - 11 12 - 13 - 14 - 15 - 16 17 - 18 - 19 - 20 - 21 22 - 24 - 27 - 30 - 32	4465	21	2.242,75

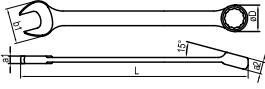

**0331**
**Kombine Anahtar Uzun Boy (SAE)**  
*Combination Wrench Long Pattern (SAE)*
**TSEK**

 WRENCHES  
 ANAHTARLAR

 Krom vanadyum, Krom kaplı  
 Chrom vanadium, Chrom plated

KOD CODE	inch	L mm	a1 mm	a2 mm	b1 mm	aD mm	g	TL/Ad.
0331 02 0005	3/16"	95	3.2	5.2	12.5	9	15	55,25
0331 02 0006	1/4"	105	3.8	5.6	14	10.5	20	57,75
0331 02 0008	5/16"	130	4.2	6.6	18	13.5	30	67,00
0331 02 0010	3/8"	154	4.7	7.6	22	16	50	76,50
0331 02 0011	7/16"	166	5	8.2	24	17.5	60	80,25
0331 02 0013	1/2"	190	5.6	9.2	28	20.5	80	90,50
0331 02 0014	9/16"	203	5.8	9.7	30	22	100	95,00
0331 02 0015	19/32"	215	6.4	10.1	32	23.5	115	100,75
0331 02 0016	5/8"	227	6.4	10.8	34	25	135	108,25
0331 02 0017	11/16"	239	6.6	11.4	36	26.5	155	115,50
0331 02 0019	3/4"	263	7.3	12.7	40	29.5	205	134,50
0331 02 0020	25/32"	275	7.7	13.2	42	31	230	143,75
0331 02 0021	13/16"	288	8.1	13.3	44	31.5	260	158,75
0331 02 0022	7/8"	300	8.5	13.7	46	34	310	182,75
0331 02 0024	15/16"	330	9	14.2	50	37	380	223,75
0331 02 0025	1"	340	9.3	14.7	52	38.5	380	223,75
0331 02 0027	1 1/16"	360	10	15.2	56	41	470	261,75
0331 02 0028	1 1/8"	370	10.4	15.7	57.5	43	470	261,75
0331 02 0030	1 3/16"	410	11.2	16.6	61.5	45	635	299,75
0331 02 0032	1 1/4"	420	11.5	17.1	65.5	48	775	314,25
0331 02 0033	1 5/16"	430	11.8	17.4	71	50.5	775	314,25
0331 02 0038	1 1/2"	450	12.5	18.7	80	56	1015	379,75

**ÖZEL SERİLER (adet ve termin süresi isteyiniz)**  
**SPECIAL SERIES (ask for quantity and delivery terms)**

0331 02 0035	1 3/8"	440	12.2	17.7	76	53	1015	5	345,25
0331 02 0036	1 7/16"	440	12.2	17.7	76	53	1015	5	345,25
0331 02 0041	1 5/8"	480	13.5	19.7	87	61	1325	5	402,50
0331 02 0046	1 13/16"	505	14.7	20.7	95	67.5	1750	5	547,00
0331 02 0050	2"	540	15.9	22.7	104	73.5	2200	5	741,75

**0331**
**Kombine Anahtar Takımı Uzun Boy (SAE)**  
*Combination Wrench Long Pattern Set (SAE)*

KOD CODE	İÇERİK CONTENTS	g	TL/Ad.
0331 00 2108	5/16" - 3/8" - 7/16" - 1/2" - 9/16" - 5/8" - 11/16" - 3/4"	925	8 767,50
0331 00 2112	5/16" - 3/8" - 7/16" - 1/2" - 9/16" - 5/8" - 11/16" - 3/4" - 13/16" - 7/8" - 15/16" - 1"	2320	12 1.556,50
0331 00 2117	1/4" - 5/16" - 3/8" - 7/16" - 1/2" - 9/16" - 19/32" - 5/8" - 11/16" - 3/4" - 25/32" - 13/16" - 7/8" - 15/16" - 1" - 1 1/16" - 1 3/16"	3875	17 2.420,25
0331 00 2120	1/4" - 5/16" - 3/8" - 7/16" - 1/2" - 9/16" - 19/32" - 5/8" - 11/16" - 3/4" - 25/32" - 13/16" - 7/8" - 15/16" - 1" - 1 1/16" - 1 1/8" - 1 3/16" - 1 1/4" - 1 5/16"	5880	20 3.310,50

**Cırcır Kombine Anahtar (mm)**  
Combination Wrench With Ratchet (mm)

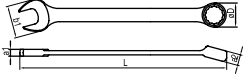

Krom vanadyum, Krom kaplı  
Chrom vanadium, Chrom plated

KOD CODE	mm	L mm	a1 mm	a2 mm	b1 mm	øD mm	g	TL/Ad.
0340 02 0008	8	140	4.9	6.4	16.9	17.1	35	10 200,50
0340 02 0009	9	149	5	6.7	19.7	19.1	40	10 200,00
0340 02 0010	10	159	5	7	21.1	20.3	55	10 209,75
0340 02 0011	11	165	5.3	7.3	24	22.5	70	10 210,75
0340 02 0012	12	171	5.6	7.6	26.5	23.5	80	10 228,50
0340 02 0013	13	178	5.9	8.1	27.7	25.3	90	10 244,75
0340 02 0014	14	190	6.3	8.5	30.7	27.5	120	10 252,25
0340 02 0015	15	199	6.7	9	32	28.8	135	10 267,25
0340 02 0016	16	208	6.7	9.5	34	30.3	155	10 306,25
0340 02 0017	17	225	7	10	36.2	32.2	190	10 324,25
0340 02 0018	18	236	7.7	10.5	38.2	33.3	200	10 351,50
0340 02 0019	19	248	8.3	11	40.4	35	240	10 373,25
0340 02 0021	21	288	9.4	13	45.7	40.7	350	10 519,25
0340 02 0022	22	288	9.4	13	45.7	40.7	340	10 569,50
0340 02 0024	24	321	10.5	14.5	52	46.2	470	5 643,25

**0340**

**Cırcır Kombine Anahtar Takımı (mm)**  
Combination Wrench With Ratchet, Set (mm)



KOD CODE	İÇERİK CONTENTS	g	TL/Ad.
0340 00 2110	8 - 9 - 10 - 11 12 - 13 - 14 - 15 - 17 - 19	1315	10 2.511,25
0340 00 2115	8 - 9 - 10 - 11 - 12 - 13 14 - 15 - 16 - 17 - 18 - 19 - 21 - 22 - 24	2445	15 4.901,00

**13000 005343**

**Cırcır Kombine Anahtar Takımı (4 parça, mm)**  
Combination Wrench With Ratchet Set (4 pcs, mm)

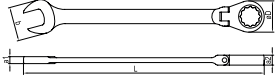

KOD CODE	İÇERİK CONTENTS	g	TL/Ad.
13000 005343	10 - 13 - 17 - 19	595	4 1.152,00

**0345**
**Mafsallı Cırcır Kombine Anahtar (mm)**
*Flexible Head Combination Wrench With Ratchet (mm)*

 Krom vanadyum, Krom kaplı  
 Chrom vanadium, Chrom plated

KOD CODE	mm	L mm	a1 mm	a2 mm	b mm	øD mm	g		TL/Ad.
0345 02 0008	8	136	5.5	7	17	17.5	40	10	331,50
0345 02 0009	9	140	6.1	7.7	21.5	21	50	10	338,25
0345 02 0010	10	140	6.1	7.7	21.5	21	60	10	351,75
0345 02 0011	11	142	6.4	8.3	23.5	22.5	80	10	362,75
0345 02 0012	12	143	6.7	8.7	26	24	90	10	383,50
0345 02 0013	13	156	7	9.3	27	26	105	10	400,00
0345 02 0014	14	164	7.3	9.4	30.5	27.5	125	10	420,50
0345 02 0015	15	174	7.7	10	32	29	145	10	441,25
0345 02 0016	16	176	8	10.6	34	30.5	185	10	480,25
0345 02 0017	17	195	8.3	10.9	37	32.5	210	10	486,50
0345 02 0018	18	213	8.6	11.2	38.5	33.5	235	10	523,75
0345 02 0019	19	214	9	11.5	40	35	260	10	547,25

**0345**
**Mafsallı Cırcır Kombine Anahtar Takımı (mm)**
*Flexible Head Combination Wrench With Ratchet, Set (mm)*



KOD CODE	İÇERİK CONTENTS	g		TL/Ad.
0345 00 2112	8 - 9 - 10 - 11 - 12 - 13 14 - 15 - 16 - 17 - 18 - 19	1365	12	5.067,25

**0335**
**Çoklu Yıldız Cırcır Anahtar (mm)**
*Multi-Ring Wrench (mm)*

 Krom vanadyum, Krom kaplı  
 Chrom vanadium, Chrom plated

KOD CODE	ÖLÇÜ SIZE	L mm	g		TL/Ad.
0335 02 0010	10x13x17x19	230	215	5	742,50

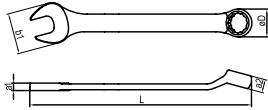
**Boyunlu Kombine Anahtar (mm)**  
*Offset Combination Wrench (mm)*

 TS 3794  
 TS ISO 7738 Form B  
 DIN 3113

 Krom vanadyum, Krom kaplı  
*Chrom vanadium, Chrom plated*
**0370**
**Boyunlu Kombine Anahtar Takımı (mm)**  
*Offset Combination Wrench, Set (mm)*

KOD CODE	mm	L mm	a1 mm	a2 mm	b1 mm	σD mm	g	TL/Ad.
0370 02 0006	6	110	3.8	5.6	16	10.5	20	10 47,75
0370 02 0007	7	120	4	6.2	18	12	25	10 50,75
0370 02 0008	8	130	4.2	6.7	20	13	30	10 55,00
0370 02 0009	9	140	4.4	7.3	22	14.5	35	10 56,25
0370 02 0010	10	150	4.6	7.8	24	16	40	10 63,75
0370 02 0011	11	160	4.8	8.4	26	17	50	10 65,50
0370 02 0012	12	167	5	9	28	18.5	65	10 70,25
0370 02 0013	13	175	5.4	9.6	30	20	75	10 72,00
0370 02 0014	14	185	5.8	10.2	32	21.5	90	10 77,25
0370 02 0015	15	195	6.2	10.8	34	23	105	10 82,25
0370 02 0016	16	210	6.6	11.4	36	24.5	120	10 88,25
0370 02 0017	17	225	7	12	38	26	160	10 94,25
0370 02 0018	18	237	7.4	12.4	40	27.5	170	10 105,00
0370 02 0019	19	250	7.8	13	42	29	200	10 110,50
0370 02 0020	20	267	8.2	13.2	44	30.5	230	10 116,00
0370 02 0021	21	283	8.6	13.8	46	32	265	10 130,50
0370 02 0022	22	295	9.1	14.6	48	34.5	300	10 149,50
0370 02 0023	23	295	9.1	14.6	48	34.5	300	5 182,50
0370 02 0024	24	329	9.4	15.4	52	37	380	5 182,50
0370 02 0025	25	329	9.4	15.4	52	37	380	5 182,50
0370 02 0026	26	360	10.2	16.8	58	41	485	5 214,75
0370 02 0027	27	360	10.2	16.8	58	41	475	5 214,75
0370 02 0028	28	360	10.2	16.8	58	41	470	5 214,75
0370 02 0029	29	394	11	18.2	64	44.5	610	5 239,25
0370 02 0030	30	394	11	18.2	64	44.5	620	5 246,75
0370 02 0032	32	435	11.8	19.7	66	47.5	765	5 258,75
0370 02 0036	36	468	12.6	21.2	76	53	1020	5 299,25

KOD CODE	İÇERİK CONTENTS	g	TL/Ad.
0370 00 2108	6 - 7 - 8 - 9 - 10 - 13 - 17 - 19	665	8 550,25
0370 00 2112	8 - 9 - 10 - 11 - 12 - 13 - 14 15 - 16 - 17 - 19 - 22	1375	12 984,75
0370 00 2117	6 - 7 - 8 - 9 - 10 - 11 - 12 - 13 - 14 15 - 16 - 17 - 18 - 19 - 20 - 21 - 22	2100	17 1.434,75
0370 00 2121	6 - 7 - 8 - 9 - 10 - 11 - 12 - 13 - 14 - 15 16 - 17 - 18 - 19 - 20 - 21 - 22 - 24 - 27 30 - 32	4425	21 2.337,50

**0380**

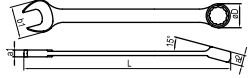
Torx® - mm Kombine Anahtar  
Torx® - mm Combination Wrench



Krom vanadyum, Krom kaplı  
Chrom vanadium, Chrom plated

**0380**

Torx® - mm Kombine Anahtar Takımı  
Torx® - mm Combination Wrench Set

KOD CODE	mm	*	L mm	a1 mm	a2 mm	b1 mm	øD mm	g	TL/Ad.	
0380 02 0008	8	E10	170	4.5	7.5	20.5	13	45	10	95,75
0380 02 0009	9	E12	180	4.5	8	22.5	14.5	45	10	97,25
0380 02 0010	10	E14	190	5	8.5	24.5	16	60	10	107,75
0380 02 0011	11	E14	200	5.5	9	26.5	17	75	10	113,75
0380 02 0012	12	E16	210	6	9.5	28.5	19	90	10	116,75
0380 02 0013	13	E18	225	6.5	10	30.5	20	110	10	128,00
0380 02 0014	14	E18	235	7	11	32.5	22	120	10	141,75
0380 02 0015	15	E20	250	7.5	12	34.5	23	150	10	150,00
0380 02 0017	17	E22	280	8.5	14	38.5	26.5	210	10	162,75
0380 02 0018	18	E24	295	9	15	40.5	28	240	10	176,75
0380 02 0019	19	E24	310	9.5	16	42.5	29.5	280	10	191,25
0380 02 0022	22	E26	350	11	18	48.5	34.5	410	10	257,25

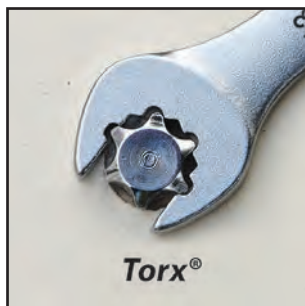

**Torx® - mm Kombine Anahtar:** Bir çatal ağız ve bir yıldız ağızdan oluşan anahtarlarımız 8-22 mm arasında boyları bulunmaktadır. Çatal ağız kısmı mevcut çatal anahtarlardan farklı olarak 6 köşe civatanın yanısıra farklı geometri lere sahip civataları açabilmekte ve sıkabilmektedir.  
TORX-mm combination wrench: Our wrenches consisting of an open end and a ring end are available in sizes from 8 to 22 mm. Unlike the existing open end wrenches, its open end can unbolt and tighten bolts with different geometries as well as the

KOD CODE	İÇERİK CONTENTS	g	TL/Ad.
	8 - 9 - 10 - 11 - 12 - 13 - 17 - 19		
0380 00 2108	E10 - E12 - E14 - E14 E16 - E18 - E22 - E24	790	8 1.013,25
	8 - 9 - 10 - 11 - 12 - 13 14 - 15 - 17 - 18 - 19 - 22		
0380 00 2112	E10 - E12 - E14 - E14 - E16 - E18 E18 - E20 - E22 - E24 - E24 - E26	1590	12 1.739,00

**Yıldız İki Ağız Anahtar (mm)**  
*Double Ended Ring Wrench (mm)*

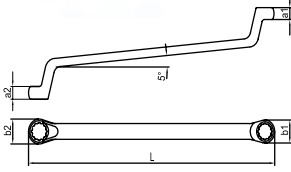
 TS 3794  
 TS ISO 10104 Form B  
 DIN 838

 Krom vanadyum, Krom kaplı  
 Chrom vanadium, Chrom plated

**0430**
**Yıldız İki Ağız Anahtar Takımı (mm)**  
*Double Ended Ring Wrench Set (mm)*

KOD CODE	mm	L mm	a1 mm	a2 mm	b1 mm	b2 mm	g	TL/Ad.
0430 03 0607	6x7	176	5.6	6	10	11.5	55	10 71,75
0430 03 0809	8x9	190	6.4	6.8	13	14.5	75	10 72,75
0430 03 0810	8x10	190	6.4	7.3	13	15.5	70	10 72,75
0430 03 1011	10x11	206	7.3	7.6	15.5	17	105	10 80,50
0430 03 1012	10x12	206	7.3	8.5	15.5	18.5	105	10 80,50
0430 03 1013	10x13	220	7.3	9	15.5	20	120	10 91,25
0430 03 1113	11x13	220	8.5	9	18.5	20	130	10 91,25
0430 03 1213	12x13	220	8.5	9	18.5	20	135	10 91,25
0430 03 1214	12x14	220	8.5	9.5	18.5	23	145	10 91,25
0430 03 1415	14x15	236	9.5	10	21.5	23	180	10 96,00
0430 03 1317	13x17	250	9	11.5	20	26.5	215	10 108,75
0430 03 1417	14x17	250	9.5	11.5	21.5	26.5	210	10 108,75
0430 03 1617	16x17	250	10.8	11.5	25	26.5	220	10 108,75
0430 03 1618	16x18	260	10.8	12	25	27.5	210	10 129,25
0430 03 1719	17x19	271	11.5	12.5	26.5	29	270	10 129,25
0430 03 1819	18x19	271	12	12.5	27.5	29	270	10 129,25
0430 03 1922	19x22	291	12.5	13.5	29	33	330	5 141,75
0430 03 1924	19x24	311	12.5	14.2	29	36.5	345	5 141,75
0430 03 2022	20x22	291	12.9	13.5	30.5	33	330	5 141,75
0430 03 2123	21x23	311	13.1	14	32	35	410	5 162,50
0430 03 2224	22x24	321	13.5	14.2	33	36.5	410	5 162,50
0430 03 2426	24x26	331	14.2	14.6	36.5	39.5	495	5 189,50
0430 03 2427	24x27	331	14.2	15	36.5	40.5	495	5 189,50
0430 03 2430	24x30	352	14.2	16.7	36.5	45	530	5 207,25
0430 03 2528	25x28	352	14.5	15.5	38	42.5	550	5 207,25
0430 03 2729	27x29	371	15	16.7	40.5	45	660	5 228,00
0430 03 2730	27x30	371	15	16.7	40.5	45	660	5 228,00
0430 03 2732	27x32	371	15	16.7	40.5	47.5	660	5 228,00
0430 03 3032	30x32	371	16.4	16.7	45	47.5	660	5 228,00
0430 03 3036	30x36	402	16.4	17.5	45	53	880	5 351,50
0430 03 3236	32x36	402	16.7	17.5	47.5	53	890	5 351,50
0430 03 3436	34x36	420	17.1	17.5	50	53	1000	5 429,75
0430 03 3641	36x41	438	17.5	19.5	53	61	1150	5 477,50
0430 03 4146	41x46	485	19.5	20.5	61	67.5	1430	5 654,25
0430 03 4650	46x50	535	20.5	22.4	67.5	73.5	1960	5 1.041,00



KOD CODE	İÇERİK CONTENTS	g	TL/Ad.
0430 00 2108	6x7 - 8x9 - 10x11 - 12x13 - 14x15 16x17 - 18x19 - 20x22	1450	8 792,00
0430 00 2112	6x7 - 8x9 - 10x11 - 12x13 - 14x15 16x17 - 18x19 - 20x22 - 21x23 24x26 - 25x28 - 27x32	3610	12 1.579,25

**ÖZEL SERİLER (adet ve termin süresi isteyiniz)**  
**SPECIAL SERIES (ask for quantity and delivery terms)**

0430 03 1014	10x14	220	7.3	9.	15.5	21.5	120	10	91,25
0430 03 1315	13x15	236	9	10	20	23	170	10	96,00
0430 03 2227	22x27	331	14.2	15	36.5	40.5	500	5	189,50
0430 03 3034	30x34	379	16.4	16.9	45	50	690	5	303,00

**0431**
**Yıldız İki Ağız Anahtar (SAE)**  
*Double Ended Ring Wrench (SAE)*
**TSEK**

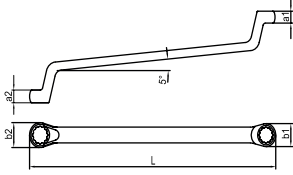
 Krom vanadyum, Krom kaplı  
 Chrom vanadium, Chrom plated

**0431**
**Yıldız İki Ağız Anahtar Takımı (SAE)**  
*Double Ended Ring Wrench, Set (SAE)*
**TSEK**

KOD CODE	inch	L mm	a1 mm	a2 mm	b1 mm	b2 mm	g	TL/ Ad.
0431 03 0608	1/4"x5/16"	176	5.6	6	10	11.5	55	10 88,50
0431 03 0809	5/16"x3/8"	190	6.4	6.8	13	14.5	75	10 92,00
0431 03 0811	5/16"x7/16"	190	6.4	7.3	13	15.5	115	10 96,25
0431 03 0911	3/8"x7/16"	206	7.3	7.6	15.5	17	115	10 101,50
0431 03 1112	7/16"x1/2"	220	8.5	9	18.5	20	135	10 109,50
0431 03 1214	1/2"x9/16"	236	9	10	20	23	145	10 115,50
0431 03 1415	9/16"x19/32"	236	9.5	10	21.5	23	165	10 115,50
0431 03 1416	9/16"x5/8"	236	9.5	10	21.5	24	165	10 116,50
0431 03 1517	19/32"x11/16"	250	10.8	11.5	25	26.5	210	10 130,50
0431 03 1920	3/4"x25/32"	271	12	12.5	27.5	29	270	10 162,00
0431 03 2122	13/16"x7/8"	311	13.1	14	32	35	400	5 194,75
0431 03 2325	15/16"x1"	331	14.2	14.6	36.5	39.5	495	5 227,25
0431 03 2631	1 1/16"x1 1/4"	371	15	16.7	40.5	48	640	5 273,50
0431 03 2833	1 1/8"x1 5/16"	371	15	16.7	40.5	48	660	5 273,50
0431 03 3033	1 3/16"x1 5/16"	371	16.4	16.7	45	48	670	5 291,75

**ÖZEL SERİLER (adet ve termin süresi isteyiniz)**  
**SPECIAL SERIES (ask for quantity and delivery terms)**

0431 03 1217	1/2"x11/16"	250	9	10	20	26.5	185	10 130,50
0431 03 1417	9/16"x11/16"	250	9.5	11.5	21.5	26.5	185	10 130,50
0431 03 1617	5/8"x11/16"	250	10.8	11.5	25	26.5	210	10 130,50
0431 03 1619	5/8"x3/4"	271	11.5	12.5	26.5	29	270	10 155,50
0431 03 2021	25/32"x13/16"	291	12.9	13.5	30.5	33	270	5 170,00
0431 03 1922	3/4"x7/8"	291	12.9	13.5	30.5	33	400	5 170,00
0431 03 2223	7/8"x15/16"	321	13.5	14.2	33	36.5	400	5 194,75
0431 03 2328	15/16"x1 1/8"	331	14.2	15	36.5	40.5	500	5 227,25
0431 03 2528	1"x1 1/8"	352	14.5	15.5	38	42.5	570	5 248,50
0431 03 3036	1 3/16"x1 3/8"	402	16.4	17.5	45	53	880	5 421,50
0431 03 3236	1 1/4"x1 7/16"	402	16.7	17.5	48	53	890	5 421,50
0431 03 3641	1 7/16"x1 5/8"	438	17.5	19.5	53	61	1100	5 573,00
0431 03 4146	1 11/16"x1 7/8"	485	19.5	20.5	61	67.5	1390	5 784,75
0431 03 4650	1 13/16"x2"	535	20.5	22.5	67.5	73.5	1955	5 1.248,75



KOD CODE	İÇERİK CONTENTS	g	TL/Ad.
0431 00 2108	1/4"x5/16" - 5/16"x3/8" 7/16"x1/2" - 9/16"x5/8" 19/32"x11/16" 3/4"x25/32" - 13/16"x7/8" 15/16"x1"	1915	8 1.121,00
0431 00 2112	1/4"x5/16" - 5/16"x3/8" 3/8"x7/16" - 7/16"x1/2" 9/16"x5/8" - 19/32"x11/16" 3/4"x25/32" - 13/16"x7/8" 15/16"x1" - 1 1/16"x1 1/4" 1 1/8"x1 5/16" 1 3/16"x1 5/16"	3985	12 2.061,25

**Düz Yıldız Anahtar (mm)**  
*Flat Ring Wrench (mm)*

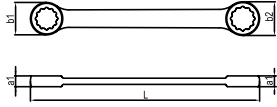
 TS 3794  
 TS ISO 10103  
 DIN 837 -B

 Krom vanadyum, Krom kaplı  
*Chrom vanadium, Chrom plated*

KOD CODE	mm	L mm	a1 mm	b1 mm	b2 mm	g	TL/Ad.
0440 03 0607	6x7	99	4.4	9.5	11	10	66,00
0440 03 0809	8x9	113	5.2	12.5	14	25	69,00
0440 03 1011	10x11	125	6	15.5	16.5	30	76,50
0440 03 1213	12x13	140	6.8	18.5	20	45	82,50
0440 03 1415	14x15	156	7.2	21	22.5	60	96,00
0440 03 1617	16x17	170	8	24	25	80	113,75
0440 03 1819	18x19	188	8.8	26.5	27.5	105	119,00
0440 03 2022	20x22	208	9.6	29	32	135	138,25
0440 03 2123	21x23	230	10.6	30	33	170	163,75
0440 03 2426	24x26	256	10.8	35	37.5	225	165,75
0440 03 2528	25x28	280	11.8	36	40.5	270	193,50
0440 03 2732	27x32	310	12.8	38.5	45.5	355	239,00

**ÖZEL SERİLER (adet ve termin süresi isteyiniz)**  
**SPECIAL SERIES (ask for quantity and delivery terms)**

0440 03 0810	8x10	120	5.6	12.5	15.5	30	10	73,75
0440 03 1013	10x13	140	6.8	18.5	20	45	10	82,50
0440 03 1315	13x15	156	7.2	20	22.5	55	10	96,00
0440 03 1317	13x17	165	7.8	20.2	25.2	85	10	113,75
0440 03 1618	16x18	188	8.8	26.5	27.5	90	10	119,00
0440 03 1719	17x19	188	8.8	26.5	27.5	105	10	119,00
0440 03 2224	22x24	230	10.8	32	35	170	10	163,75
0440 03 2427	24x27	256	10.8	35	38.5	225	10	165,75
0440 03 2729	27x29	290	12.8	38.5	42.5	285	10	221,00
0440 03 3032	30x32	310	12.8	43	45.5	360	10	239,00

**0440**
**Düz Yıldız Anahtar Takımı (mm)**  
*Flat Ring Wrench, Set (mm)*

KOD CODE	İÇERİK CONTENTS	g	TL/Ad.
0440 00 2108	6x7 - 8x9 - 10x11 - 12x13 - 14x15 16x17 - 18x19 - 20x22	560	8 761,00
0440 00 2112	6x7 - 8x9 - 10x11 - 12x13 - 14x15 16x17 - 18x19 - 20x22 - 21x23 24x26 - 25x28 - 27x32	1540	12 1.523,00



**0435**
**Süper İzoleli Bir Ağız Yıldız Anahtar (mm)**  
*Single Ended Ring Wrench Super Insulated (mm)*

⚡ 1000 V

IEC 60900

**Krom vanadyum, Krom kaplı, Kalın PVC izoleli**  
*Chrom vanadium, Chrom plated, Triple PVC insulated*

KOD CODE	mm	L mm	g	TL/Ad.
0435 03 0010	10	170	100	143,25
0435 03 0011	11	175	110	143,25
0435 03 0012	12	180	130	162,50
0435 03 0013	13	185	150	162,50
0435 03 0014	14	190	180	170,75
0435 03 0017	17	205	220	193,25
0435 03 0019	19	220	270	230,75
0435 03 0022	22	245	310	252,75
0435 03 0024	24	270	420	337,75

**0540**
**Rakor Anahtar (mm)**  
*Flare Nut Wrench (mm)*

DIN 3118

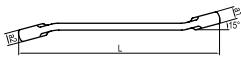
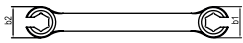
**Krom vanadyum, Krom kaplı**  
*Chrom vanadium, Chrom plated*

KOD CODE	mm	L mm	a1 mm	a2 mm	b1 mm	b2 mm	g	TL/Ad.
0540 01 0810	8x10	130	7	8.5	18	20	60	131,75
0540 01 1011	10x11	150	8.5	9.3	20	22	75	136,75
0540 01 1012	10x12	150	8.5	9.3	20	22	75	136,75
0540 01 1113	11x13	170	9.3	10.8	22	25.5	105	146,50
0540 01 1214	12x14	170	9.3	10.8	22	25.5	105	146,50
0540 01 1719	17x19	210	11.8	13	30.5	33.5	185	261,50
0540 01 1922	19x22	230	12.8	14.9	33.5	39.5	235	313,00

**0530**
**Yarım Ay Anahtar Yıldız İki Ağız (mm)**  
*Double - Hex Starter and Block Wrench (mm)*

TSEK

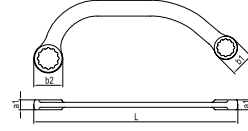
**Krom vanadyum, Krom kaplı**  
*Chrom vanadium, Chrom plated*

KOD CODE	mm	L mm	a1 mm	b1 mm	b2 mm	g	TL/Ad.
0530 04 0810	8x10	120	6	12.5	15.5	30	85,00
0530 04 1011	10x11	150	7	17	20	55	99,75
0530 04 1012	10x12	150	7	17	20	55	99,75
0530 04 1113	11x13	150	7	17	20	55	99,75
0530 04 1315	13x15	185	9	21.5	26	110	118,75
0530 04 1317	13x17	185	9	21.5	26	105	118,75
0530 04 1417	14x17	185	9	21.5	26	110	118,75
0530 04 1517	15x17	185	9	21.5	26	100	118,75
0530 04 1922	19x22	230	11	29	33	195	154,50

**0531**
**Yarım Ay Anahtar Yıldız İki Ağız (SAE)**  
*Double - Hex Starter and Block Wrench (SAE)*

TSEK

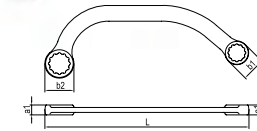

**Krom vanadyum, Krom kaplı**  
*Chrom vanadium, Chrom plated*

KOD CODE	inch	L mm	a1 mm	b1 mm	b2 mm	g	TL/Ad.
0531 04 1112	7/16"x1/2"	150	7	17	20	50	123,00
0531 04 1214	1/2"x9/16"	185	9	21.5	26	110	143,00
0531 04 1416	9/16"x5/8"	185	9	21.5	26	115	147,25
0531 04 1922	3/4"x7/8"	230	11	29	33	195	185,50

**ÖZEL SERİLER (adet ve termin süresi isteyiniz)**  
**SPECIAL SERIES (ask for quantity and delivery terms)**

0531 04 0809	5/16"x3/8"	120	6	12.5	15.5	30	101,75
0531 04 0911	3/8"x7/16"	150	7	17	20	50	119,75
0531 04 1417	9/16"x11/16"	185	9	21.5	26	110	142,50

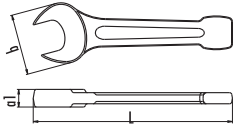
**Çatal Çakma Anahtar (mm)**  
*Slugging Open Jaw Wrench (mm)*

 TS 81  
 DIN 133

 Krom vanadyum  
 Chrom vanadium

KOD CODE	mm	L mm	a1 mm	b mm	g		TL/Ad.
0700 05 0024	24	160	14	50	280	1	171,25
0700 05 0027	27	180	15	55	385	1	212,50
0700 05 0030	30	190	16	64	525	1	261,00
0700 05 0032	32	190	16	64	530	1	293,00
0700 05 0036	36	210	18	75	755	1	329,00
0700 05 0038	38	210	18	75	760	1	396,00
0700 05 0041	41	230	18	85	920	1	430,00
0700 05 0042	42	230	18	85	930	1	497,00
0700 05 0046	46	255	20	95	1305	1	547,00
0700 05 0047	47	255	20	95	1320	1	638,75
0700 05 0050	50	275	20	105	1565	1	683,25
0700 05 0055	55	310	23	119	2305	1	915,75
0700 05 0060	60	310	23	119	2310	1	994,25
0700 05 0065	65	340	28	135	3300	1	1.430,25
0700 05 0070	70	375	31	154	4555	1	1.830,75
0700 05 0075	75	375	31	154	4460	1	1.939,75
0700 05 0080	80	405	34	169	6115	1	2.466,75
0700 05 0085	85	405	34	169	5740	1	3.270,00
0700 05 0090	90	445	38	189	8040	1	3.364,50
0700 05 0095	95	445	38	189	8160	1	3.588,00
0700 05 0100	100	485	44	214	12355	1	5.085,25
0700 05 0105	105	485	44	214	11785	1	5.243,75
0700 05 0110	110	510	50	234	15000	1	5.983,25
0700 05 0115	115	510	50	234	14830	1	6.873,25
0700 05 0120	120	543	54	254	18865	1	7.255,00

**ÖZEL SERİLER (adet ve termin süresi isteyiniz)**  
**SPECIAL SERIES (ask for quantity and delivery terms)**

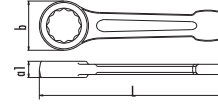
0700 05 0125	125	543	54	254	17250	1	-----
0700 05 0130	130	560	56	275	20000	1	-----
0700 05 0135	135	560	56	275	19700	1	-----
0700 05 0140	140	630	58.5	310	19400	1	-----
0700 05 0145	145	630	58.5	310	28000	1	-----
0700 05 0150	150	630	58.5	310	27600	1	-----

**Yıldız Çakma Anahtar (mm)**  
*Slugging Ring Wrench (mm)*
  
 TS 3794  
 DIN 7444

 Krom vanadyum  
 Chrom vanadium

KOD CODE	mm	L mm	a1 mm	b mm	g		TL/Ad.
0750 05 0024	24	160	15	41.5	235	1	240,00
0750 05 0027	27	180	16	45.5	325	1	286,50
0750 05 0030	30	190	17	51	435	1	341,75
0750 05 0032	32	190	17	51	425	1	392,75
0750 05 0036	36	205	19	58	550	1	444,50
0750 05 0038	38	205	19	58	530	1	532,25
0750 05 0041	41	225	20	63	730	1	581,00
0750 05 0042	42	225	20	63	700	1	664,25
0750 05 0046	46	240	22	71	970	1	694,75
0750 05 0047	47	240	22	71	930	1	766,50
0750 05 0050	50	255	23	77	1160	1	820,25
0750 05 0055	55	272	25	88	1520	1	1.153,75
0750 05 0060	60	272	25	88	1460	1	1.251,75
0750 05 0065	65	300	28	98	2025	1	1.636,50
0750 05 0070	70	330	32	108	2890	1	1.873,50
0750 05 0075	75	330	32	108	2755	1	2.005,25
0750 05 0080	80	360	35	126	4000	1	2.848,25
0750 05 0085	85	360	35	126	3620	1	3.204,50
0750 05 0090	90	390	40	140	5465	1	3.941,75
0750 05 0095	95	390	40	140	5250	1	4.444,75
0750 05 0100	100	420	44	148	6755	1	5.138,25
0750 05 0105	105	420	44	148	6445	1	5.304,00
0750 05 0110	110	450	48	166	8500	1	5.670,00
0750 05 0115	115	450	48	166	8460	1	6.355,75
0750 05 0120	120	490	54	178	10000	1	8.735,25

**ÖZEL SERİLER (adet ve termin süresi isteyiniz)**  
**SPECIAL SERIES (ask for quantity and delivery terms)**

0750 05 0125	125	490	54	178	9900	1	-----
0750 05 0130	130	518	59	196	16000	1	-----
0750 05 0135	135	518	59	196	15900	1	-----
0750 05 0140	140	518	59	196	15800	1	-----
0750 05 0145	145	580	61.8	223	22000	1	-----
0750 05 0150	150	580	61.8	223	21900	1	-----
0750 05 0155	155	580	61.8	223	21800	1	-----
0750 05 0160	160	580	61.8	223	21700	1	-----
0750 05 0165	165	648	67	262	30000	1	-----
0750 05 0170	170	648	67	262	29800	1	-----
0750 05 0180	180	648	67	262	29700	1	-----

## 0550

### Boru Uzatmalı Yıldız Anahtar (mm) Offset Ring Wrench (mm)

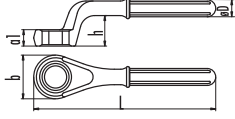

Krom vanadyum, Krom kaplı  
Chrom vanadium, Chrom plated

KOD CODE	mm	L mm	a1 mm	b mm	σD mm	h mm	g	TL/Ad.
0550 05 0024	24	180	17	37	18.5	30	400	1 250,75
0550 05 0027	27	190	18	42	18.5	33	450	1 299,00
0550 05 0030	30	200	20	46	18.5	34	520	1 357,00
0550 05 0032	32	235	21.5	49	21.2	37	700	1 410,00
0550 05 0036	36	245	23	53.5	21.2	42	830	1 463,75
0550 05 0038	38	270	25	60.5	21.2	43	965	1 535,00
0550 05 0041	41	270	25	60.5	21.2	43	950	1 606,00
0550 05 0046	46	280	26	68	24.2	45	1240	1 725,00
0550 05 0050	50	290	28	74	24.2	47	1410	1 856,00
0550 05 0055	55	300	30	79	24.2	50	1550	1 1.204,00
0550 05 0060	60	345	32	89	29	50.5	2390	1 1.306,50
0550 05 0065	65	355	34	98	29	56.5	2730	1 1.414,75

### ÖZEL SERİLER (adet ve termin süresi isteyiniz) SPECIAL SERIES (ask for quantity and delivery terms)

0550 05 0022	22	180	17	37	18.5	30	400	1	----
0550 05 0034	34	235	21.5	49	21.2	37	750	1	----
0550 05 0070	70	365	37	104	29	55	2900	1	----
0550 05 0075	75	375	40	109	29	57.5	3100	1	----
0550 05 0080	80	385	43	124	29	59	3900	1	----
0550 05 0085	85	385	43	124	29	59	3750	1	----
0550 05 0090	90	410	46	140	29	63	5100	1	----
0550 05 0095	95	410	46	140	29	63	4950	1	----
0550 05 0100	100	420	46	150	29	65	4800	1	----

## 0551

### Döndürme Kolu Borusu Tubular Handle



Dikişsiz Çelik Boru  
Seamless Steel Pipe

KOD CODE	mm	L mm	σ mm	g	TL/Ad.
0551 05 0001	22 - 30	460	25	700	1 234,50
0551 05 0002	32 - 41	610	27	1220	1 317,75
0551 05 0003	46 - 55	760	32.2	1880	1 476,50
0551 05 0004	60 - 100	860	38	2975	1 643,00

## 0600

### Kurbağacak Anahtar Adjustable Wrench

TS 3796  
DIN 3117



Yedek parça sayfa 202  
Spare parts pagem 202



IZELTAS YOUTUBE

Krom vanadyum, Krom kaplı, PVC izoleli  
Chrom vanadium, Chrom plated, PVC insulated

KOD CODE	L mm	L inch	a mm	g	TL/Ad.
0600 01 1006	160	6"	18	120	5 230,75
0600 01 1008	208	8"	23	230	5 288,50
0600 01 1010	260	10"	28	400	5 371,75
0600 01 1012	308	12"	34	670	5 513,75
0600 01 1015	388	15"	43	1555	1 805,00

## 0860

### Kanca Anahtar (dörtgen uçlu) Hook Wrench

TS 3798  
DIN 1810

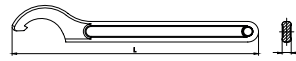

Krom vanadyum, Krom kaplı  
Chrom vanadium, Chrom plated

KOD CODE	mm	L mm	a1 mm	g	TL/Ad.
0860 05 2528	25/28	136	4	50	10 123,00
0860 05 3032	30/32	136	4	50	10 123,00
0860 05 3436	34/36	171	5	95	10 133,00
0860 05 4042	40/42	171	5	95	10 133,00
0860 05 4550	45/50	210	6	160	10 154,00
0860 05 5255	52/55	210	6	160	10 154,00
0860 05 5862	58/62	242	7	270	5 185,75
0860 05 6875	68/75	242	7	270	5 185,75
0860 05 8090	80/90	281	8	400	5 242,50
0860 05 9510	95/100	281	8	400	5 242,50

**Ayarlı Montaj Anahtarı**  
*Adjustable Speed Wrench*

IZELTAS USTA İŞİ  
SOHBETLER

**Yedek parça sayfa 202**  
*Spare parts page 202*

**Krom vanadyum, Krom kaplı**  
*Chrom vanadium, Chrom plated*

6 ile 22 mm arası **Altı Köşe, Torx, XZN, Ribe, Kare** gibi farklı geometriye sahip cıvataları açabilme imkanı sağlar. Anahtarı cıvata başından tam olarak çıkarmadan açma ve sıkma hareketi olanağı sağlar. Anahtar sapına özel olarak açılmış 10-13-15 mm altı köşe cıvataları açabilme imkanı sağlar

*Allows to open bolts with different geometry such as **Hexagon, Torx, XZN, Ribe, Square** in sizes from 6 to 22 mm. Enables unbolting and tightening turn without removing the wrench completely from the bolt head. Specially opened 10-13-15 mm holes on the handle, allows to open hexagon bolts.*

KOD CODE	L mm	L inch	a mm	 g	 5	TL/Ad.
0615 01 0200	200	8"	6-22	220	5	378,75



## MCD ÇOK NOKTADAN TEMAS PROFİLİ / MCD MULTI CONTACT DRIVE PROFILE



### İzeltas Yeni Jenerasyon Yıldız Anahtar Profili

MCD, Multi Contact Drive (çoklu temas), sıkma performansının geliştirilmesi amacıyla dizayn edilmiştir. Bilgisayar destekli titiz çalışmaların sonucunda geliştirilen MCD, klasik 12 köşe anahtardan çok daha kullanışlı, çok daha güçlüdür.

En önemli özelliği, yıldız kafadaki çoklu temas yüzeyleridir. Bu sayede civata ve somunla maksimum temas sağlanır. Böylece basınç tüm köşelere eşit olarak dağılır, temas edilen yüzeylerdeki olası hasarlar önlenir, aletin ömrü uzar.

- Yıldız kafadaki yeni profil, düzensiz bir dalga şeklindedir. Güç, civatanın köşelerine değil, yan yüzeylerine etki eder (çoklu temas). Basınç daha dengeli dağıldığından temas edilen yüzeylerde ezilme meydana gelmez.
- Tolerans dışı civatalar için de uygundur.
- Civata başlarının köşelerini ezmez.
- Geniş temas alanı, anahtar ömrünü arttırır.
- Bozuk ve deforme olmuş civataları kolayca açar.

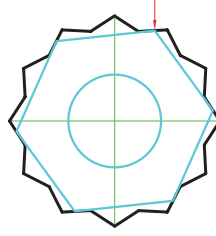

Çoklu Temas / Multi Point Contact

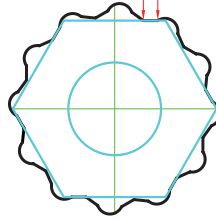

MCD Profil  
MCD Profile

### IZELTAS New Generation Ring Wrench Profile

MCD (Multi Contact Drive) is designed to improve the driving performance of the ring wrench. MCD, designed through computer aided drafting, transmits more torque and has longer life than conventional 12 edge ring profile.

Multi point contact is the source of effectiveness, where maximum surface area is in touch with fastener flats. Increased contact also maximizes tool's life through decreased pressure on the contact points.

- New profile of the ring wrench is formed of curves. Torque is transmitted through these curves rather than edges. As the stress is balanced between enlarged surfaces, the risk of deformation is minimized.
- It is possible to drive off-tolerance fasteners.
- Does not deform the fastener edges.
- Larger contact area increases tool's life.
- Works well with deformed fasteners.

## MONTAJ ANAHTARI / SPEED WRENCH



### %100 Daha Hızlı

Yeni tasarlanan montaj anahtarı, 2 kat hızlı cırcır mekanizması mantığına dayanan çalışma prensibinden alır. Kullanım sırasında, montaj anahtarını civatadan ayırmadan döndürme kolaylığı kullanım hızını arttırırken, civata köşelerine sağlam tutunan anahtar profili güvenli ve kaydırmaz kullanım sağlar.

### Uzun Ömür

Bu yeni montaj anahtarı profili, civata ve somunlar ile köşelerinden değil düz yüzeyleri üzerinden temas ederek düzenli tork iletimini sağlarken, gerilimin artmasını da engelleyerek anahtar ömrünün uzamasını sağlar.

- Anahtarı civatadan ayırmadan hızlı kullanım.
- Güvenli tork iletimi ve uzun ömür.

### 100% Faster

New designed speed wrench takes its 100% faster rotational drive from the ratchet mechanism principle. Rotating the tool without the need for removing from the fastener provides faster usage, while enabling safer and slip-free usage with fully gripping upper and lower jaws.

### Longer Tool Life

This new speed wrench profile contacts the fasteners from their flats rather than edges, which provides balanced torque transmission and decreases stress accumulation on the edges increasing the tool life considerably.

- Fast drive without removing the wrench from the fastener.
- Firm torque transmission and longer life.

## AYARLI MONTAJ ANAHTARI / ADJUSTABLE SPEED WRENCH



6 ile 22 mm arası altı köşe, torx,yive ,ribe, kare gibi farklı geometriye sahip civataları açabilme imkanı sağlar. Anahtarı civata başından tam olarak çıkarmadan açma ve sıkma hareketi olanağı sağlar. Anahtar sapına özel olarak açılmış 10-13-15 mm altı köşe civataları açabilme imkanı sağlar

This tool is used for all different shapes of bolts between 6 and 22 mm. Contact between the tool and bolt is not removed to loosen and tighten the bolt. With the hexagonal holes in the handle, tool also can be used for 10-13-15mm bolts and nuts.



**İZELTAS®**

# LOKMA VE BİJON ANAHTARLARI

## SOCKETS AND RIM WRENCHES

Lokma Anahtarlar  
Socket Wrenches

Lokma Takımları  
Socket Wrench Sets

Kovan Anahtarlar  
Tubular Socket Wrenches

Bijon Anahtarlar  
Rim Wrenches

Tork Anahtarları  
Torque Wrenches



İZELTAS YOUTUBE

SOCKETS AND  
RIM WRENCHES

LOKMA BİJON  
ANAHTARLARI

## Tork (Moment) ve Kuvvet / Torque (Moment) and Force

» Bilindiği üzere kuvvet bir cisme hareketini veren etkidir. Tork ise cismin bir kuvvet etkisinde döndürülmesidir. Bağlantı elemanlarını sıkma işlemlerinde genel olarak yıldız, çatal ya da lokma anahtar gibi çeşitli el aletleri kullanılır. Bu işlem fiziksel olarak işlevsel ve doğru olarak gözüke de vida, cıvata bağlantısının güvenilirliği açısından doğru bir çalışma şekli değildir. Bir vida-cıvata bağlantısının çözülmeye karşı en büyük emniyeti teorik olarak hesaplanmış olan tork değeri ile sıkılmasıdır. Bu da ancak çeşitli modern yöntemler ile sağlanabilir. Örneğin; tork anahtarı ile sıkmak, motor tahrikli sıkma işlemleri, ultrason ile sıkmak gibi. Çeşitli uygulamalar tork anahtarı kullanımının daha makul olduğunu göstermiştir.

» As you know, force is the effect which imparts movement to an object. Torque, is rotation of an object under effect of force. Various hand tools like a Philips head screwdriver, for spanner or socket wrench are used to tighten connection elements. While this process appears functional and correct, it is not an appropriate procedure for reliability of the threaded connection. The greatest safety of a threaded connection against loosening is being tightened at a certain torque level theoretically calculated beforehand. This can only be ensured with various modern methods. For example, tightening with a torque wrench, motor-driven tightening or ultrasound supported tightening. Various applications have shown that use of a torque wrench is more appropriate.



### Sıkma Torku Nedir ?

» Sıkma torku, kuvvet etkisiyle döndürme kolunun uç kısmındaki anahtar ağızında oluşturulur ve birimi Nm'dir. Bu sıkma torku vida bağlantısında bir ön gerilme yaratır. Sıkma torkunun olması gerekenden düşük olması, zamanla oluşabilecek titreşimler sebebiyle vida-cıvata bağlantısında gevşeme/çözülmeye yol açabilir. Ön gerilme kuvveti fazlaca oluşan bağlantılarda ise parçalara zarar verebilir, aynı zamanda vida üzerindeki dişlerde meydana gelecek aşınmalar bağlantıyı çözülemez kılabilir.

### What is Tightening Torque ?

» Tightening torque is generated at the wrench tip at the terminus of the rotating lever under the effect of force, and its unit is Nm. This tightening torque creates a pre-tension on the threaded connection. Tightening torque being lower than what is necessary can cause the threaded connection to loosen/unravel due to vibrations that might occur over time. On the other hand, pre-tension force being over what is necessary can cause damage on the connection parts, as well as causing the threads on the connection piece to wear off or causing the connection become non-severable.

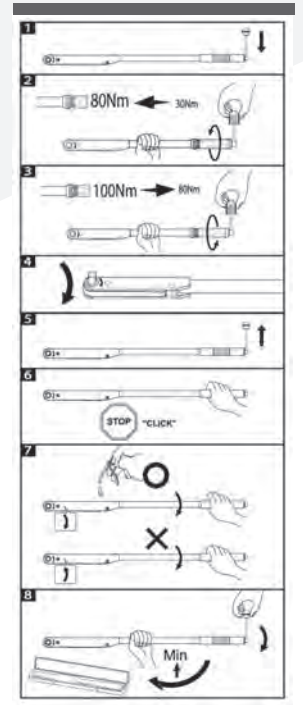



## Tork Anahtarlarının Doğru Kullanımı

- » Tork anahtarı ile çalışırken dikkat edilmesi gereken bazı hususlar bulunmaktadır. Bunlardan başlıcaları;
- Hangi tip tork anahtarı olursa olsun döndürme yönünün aksine kuvvet uygulanmaması gereklidir.
  - Cırcır anahtarlar gibi tork anahtarlarının da sökme işlemi için kullanılmaması gerekir.
  - Klik sesli modellerde klik sesi duyulduğu anda ayarlanmış tork değerine ulaşılmış demektir, daha fazla kuvvet uygulanmamalıdır.
  - Gövdesi hasar görmüş, mekanizması bozulmuş tork anahtarlarını kullanmaya devam etmeyiniz.
  - Kuvvet, tork anahtarının sap kısmından uygulanmalıdır.
  - Kullanımdan sonra nemden ve kirden korumak için her zaman kutusunda muhafaza ediniz.
  - Her kullanımdan sonra tork anahtarındaki yükü "0 Nm" konumuna getiriniz.
  - Tork anahtarlarını kendi başınıza tamir etmeye çalışmayınız.



## Correct Use Of Torque Wrenches

- » There are some important points that must be kept in mind when working with a torque wrench. Some of these include the following.
- No matter which type of torque wrench is used, force should not be applied at the opposite of rotating direction.
  - Torque wrenches like ratchet wrenches should not be used to loosen connections.
  - In models with click sound option, the click indicates the set torque value is achieved and further force should not be applied from then on.
  - Do not continue using torque wrenches with a damaged body or mechanism.
  - Force should be applied at the handle part of the torque wrench.
  - The tool should always be kept in its box after use to protect against moisture and dirt.
  - The load set of the torque wrench should be adjusted to "0 Nm" after each use.
  - Please do not attempt to repair torque wrenches on your own.

## Tork Anahtarlarının Kalibrasyonu

- » Tork anahtarlarının doğru çalışması ve bağlantıların sağlıklı sıkılabilmesi için kalibrasyon işlemi büyük önem arz etmektedir. TS EN ISO 6789-1 Standardına göre tork anahtarlarının ilk kullanımdan itibaren geçerli olmak üzere 12 aylık bir periyotta veya her 5000 kullanımlık çevrim sonunda kalibre edilmesi önerilmektedir.

## Calibration Of Torque Wrenches

- » Calibration process carries great importance for torque wrenches to function correctly and be able to tighten connections in a healthy fashion. TS EN ISO 6789-1 Standard stipulates torque wrenches should be calibrated with 12 month periods or after each cycle of 5000 uses starting from the first use.

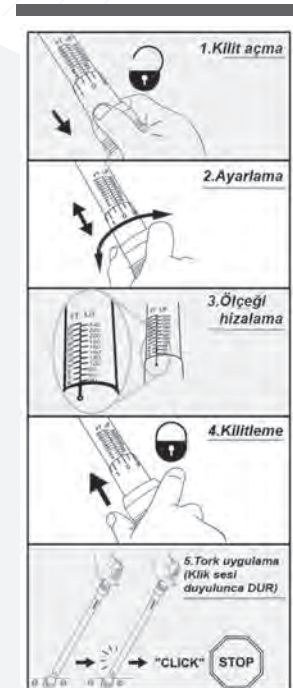

**1/2" ALTI KÖŞE LOKMA ANAHTAR/SOCKET WRENCH 6 POINTS**

Nikel üzeri krom kaplama ile korozyon direncinde üst seviye koruma  
Corrosion protection with nickel over chrome plating

Yüksek dayanım için üst toleranslarda tasarım  
Improved durability with upper tolerance thickness

En uygun temas yüzeyi için hassas dövülmüş altı köşe ağızlar  
Precise forged hex shape for best contact area



Bilya stoplama yuvalı hassas işlenmiş kare kanal  
Precise machined square adapter with ball stopper Groove

Yüksek mukavemetli alaşımlı sıcak dövme çeliği  
High strength alloyed forged steel

Extra sürtünme kabiliyeti için tırtıklı tasarım  
Extra friction capability with knurled design



İZELTAS USTA İŞİ  
SOHBETLER



İZELTAS YOUTUBE

## 1107

1/4" Altı Köşe Lokma Anahtar (mm)  
Socket Wrench 6 Points (mm)

TS ISO 2725 -1  
DIN 3124

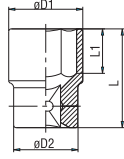

1/4"

Krom vanadyum, Krom kaplı, Polisajlı  
Chrom vanadium, Chrom plated, Polished

KOD CODE	mm	ø D1 mm	ø D2 mm	L mm	L1 mm	g	TL/Ad.
1107 06 0004	4	6.8	11.8	25	4	10	10
1107 06 0045	4.5	7.4	11.8	25	5	10	10
1107 06 0005	5	8	11.8	25	6	10	10
1107 06 0055	5.5	8.5	11.8	25	6	10	10
1107 06 0006	6	9.2	11.8	25	7	10	10
1107 06 0007	7	10.8	11.8	25	7	10	10
1107 06 0008	8	11.9	11.8	25	8	10	10
1107 06 0009	9	12.9	12.8	25	8	15	10
1107 06 0010	10	14.3	14.3	25	9	20	10
1107 06 0011	11	15.8	15.8	25	9	20	10
1107 06 0012	12	16.8	16.8	25	9	25	10
1107 06 0013	13	17.8	17.8	25	9	30	10

## 1107

1/4" Altı Köşe Derin Lokma Anahtar (mm)  
Deep Socket Wrench 6 Points (mm)

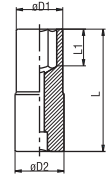

1/4"

Krom vanadyum, Krom kaplı, Polisajlı  
Chrom vanadium, Chrom Plated, Polished

KOD CODE	mm	ø D1 mm	ø D2 mm	L mm	L1 mm	g	TL/Ad.
1107 06 4004	4	6.8	11.8	50	6	10	10
1107 06 4005	5	8	11.8	50	7	20	10
1107 06 4055	5.5	8.7	11.8	50	9	20	10
1107 06 4006	6	9.2	11.8	50	9	25	10
1107 06 4007	7	10.8	11.8	50	15	25	10
1107 06 4008	8	11.8	11.8	50	15	25	10
1107 06 4009	9	13	13	50	15	30	10
1107 06 4010	10	14.5	14.5	50	15	40	10
1107 06 4011	11	15.8	15.8	50	21	45	10
1107 06 4012	12	16.8	16.8	50	21	50	10
1107 06 4013	13	17.8	17.8	50	21	55	10

## 1107

1/4" Altı Köşe Derin Lokma Anahtar Set (14 parça, mm)  
Deep Socket Wrench Set Type 6 Points (14 pcs, mm)



1/4"

KOD CODE	LOKMALAR Sockets	AVADANLIKLAR Accessories	g	TL/Ad.
1107 00 6014	4-5-5.5-6 7-8-9-10 11-12-13	1/4" Cırcır Kol Ratchet Handle	1005	14
	Altı Köşe Derin Lokma Deep Socket Wrench 6 Points	1/4" Ara Kol Extension Bar 50 mm		
		1/4" Ara Kol Extension Bar 100 mm		

**1107**

1/4" Lokmalı Allen Uç  
Hexagonal Bit Socket Wrench

**1/4"**

Krom vanadyum, Krom Kaplı  
Chrom vanadium, Chrom Plated

KOD CODE	mm	L mm	g		TL/Ad.
1107 06 1125	2.5	37	13	10	22,25
1107 06 1103	3	37	13	10	22,25
1107 06 1104	4	37	15	10	22,25
1107 06 1105	5	37	15	10	22,25
1107 06 1106	6	37	15	10	22,25
1107 06 1107	7	37	16	10	26,25
1107 06 1108	8	37	17	10	26,25
1107 06 1110	10	37	19	10	31,50

**1107**

1/4" Lokmalı Star Delikli (Torx®) Uç  
Tamper Resistant Torx  
Bit Socket Wrench

**1/4"**

Krom vanadyum, Krom Kaplı  
Chrom vanadium, Chrom Plated

KOD CODE		L mm	g		TL/Ad.
1107 06 1308	TR8	37	13	10	26,75
1107 06 1309	TR9	37	13	10	26,75
1107 06 1310	TR10	37	13	10	26,75
1107 06 1315	TR15	37	14	10	26,75
1107 06 1320	TR20	37	14	10	26,75
1107 06 1325	TR25	37	14	10	26,75
1107 06 1327	TR27	37	14	10	26,75
1107 06 1330	TR30	37	15	10	26,75
1107 06 1340	TR40	37	16	10	31,25

**1107**

1/4" Lokmalı Star (Torx®) Uç  
Torx Bit Socket Wrench

**1/4"**

Krom vanadyum, Krom Kaplı  
Chrom vanadium, Chrom Plated

KOD CODE		L mm	g		TL/Ad.
1107 06 1208	T8	37	12	10	23,00
1107 06 1209	T9	37	12	10	23,00
1107 06 1210	T10	37	13	10	23,00
1107 06 1215	T15	37	14	10	23,00
1107 06 1220	T20	37	14	10	23,00
1107 06 1225	T25	37	14	10	23,00
1107 06 1227	T27	37	14	10	23,00
1107 06 1230	T30	37	15	10	23,00
1107 06 1240	T40	37	16	10	23,00

**1107**

1/4" Lokmalı Düz Uç  
Slotted Bit Socket Wrench

**1/4"**

Krom vanadyum, Krom Kaplı  
Chrom vanadium, Chrom Plated

KOD CODE		L mm	g		TL/Ad.
1107 06 1403	3	37	13	10	22,25
1107 06 1435	3.5	37	14	10	22,25
1107 06 1404	4	37	14	10	22,25
1107 06 1445	4.5	37	14	10	22,25
1107 06 1455	5.5	37	15	10	22,25
1107 06 1465	6.5	37	15	10	22,25
1107 06 1407	7	37	16	10	22,25
1107 06 1408	8	37	16	10	29,00
1107 06 1410	10	37	17	10	31,25

## 1107

### 1/4" Lokmalı Yıldız Uç Phillips Bit Socket Wrench



1/4"

Krom vanadyum, Krom Kaplı  
Chrom vanadium, Chrom Plated

KOD CODE	+	L mm	g	□	TL/Ad.
1107 06 1501	Ph 1	37	14	10	22,25
1107 06 1502	Ph 2	37	14	10	22,25
1107 06 1503	Ph 3	37	15	10	22,25
1107 06 1504	Ph 4	37	16	10	22,25

## 1107 00 1042

### 1/4" Bits Uçlu Lokma Set (42 Parça) Bit Socket Wrench Set (42 Pcs)



1/4"

KOD CODE	İÇERİK CONTENTS	□	TL/Ad.
1107	<b>1/4" Lokmalı Star Torx® Uçlar</b> Torx® Bit Socket T8-T9-T10-T15-T20-T25-T27-T30-T40	42	1.297,00
	<b>1/4" Lokmalı Star Delikli Torx® Uçlar</b> Tamper Resistant Torx® Bit Socket Wrench TR8-TR9-TR10-TR15-TR20-TR25-TR27 TR30-TR40		
	<b>1/4" Lokmalı Allen Uçlar</b> Hexagonal Bit Socket Wrench 2.5-3-4-5-6-7-8-10		
	<b>1/4" Lokmalı Düz Uç</b> Slotted Bit Socket Wrench 3-3.5-4-4.5-5.5 6.5-7-8-10		
	<b>1/4" Lokmalı Yıldız Uç</b> Phillips Bit Socket Wrench Ph1-Ph2-Ph3-Ph4		
	<b>1/4" Cırcır kolu</b> Ratchet Handle		
	<b>1/4" Ara Kol</b> Extension Bar 100 mm		
	<b>1/4" Lokma Tornavida Adaptörü</b> Spindle Handle		

## 1507

### 1/4" Ara Kol Extension Bar

TS ISO 3316  
DIN 3123



1/4"

Krom vanadyum, Krom kaplı, Polisajlı  
Chrom vanadium, Chrom plated, Polished

KOD CODE	L mm	g	□	TL/Ad.
1507 06 0050	50	25	5	33,25
1507 06 0100	100	45	5	36,00

## 1507

### 1/4" Ara Kol Flexible Flexible Extension



1/4"

Krom vanadyum, Krom kaplı  
Chrom vanadium, Chrom plated

KOD CODE	L mm	g	□	TL/Ad.
1507 06 3150	150	70	5	146,75

## 1507

### 1/4" Mafsal Universal Joint

TS ISO 1174  
DIN 3123



1/4"

Krom vanadyum, Krom kaplı, Polisajlı  
Chrom vanadium, Chrom plated, Polished

KOD CODE	L mm	g	□	TL/Ad.
1507 06 0038	38	25	5	61,00

## 1507

### 1/4" T Kol Sliding T - Handle

TS ISO 3315  
DIN 3122



1/4"

Krom vanadyum, Krom kaplı, Polisajlı  
Chrom vanadium, Chrom plated, Polished

KOD CODE	L mm	g	□	TL/Ad.
1507 06 4115	115	45	5	59,75

**1507**

1/4" Cırcır Kolu  
Ratchet Handle

TS ISO 3315



**1/4"**

Krom vanadyum, Krom kaplı, Polisajlı  
Chrom vanadium, Chrom plated, Polished

KOD CODE	L mm	g		TL/Ad.
1507 06 2140	140	140	5	237,75

**1507**

1/4" Mandallı Cırcır Kolu  
Ratchet With Latch

TS ISO 3315



**1/4"**

Krom vanadyum, Krom kaplı, Polisajlı  
Chrom vanadium, Chrom plated, Polished

KOD CODE	L mm	g		TL/Ad.
1507 06 6140	140	140	5	340,25

**1507**

1/4" Mafsallı Cırcır Kolu (72 Diş)  
Swivel Head Ratchet (72 Teeth)



**1/4"**

Krom vanadyum, Krom kaplı, Polisajlı  
Chrom vanadium, Chrom plated, Polished

KOD CODE	L mm	g		TL/Ad.
1507 06 2150	150	130	5	788,75

**1507**

1/4" Lokma/Bits Tutuculu Cırcır Kolu (72 Diş)  
Socket/Bit Holder mini Ratchet (72 Teeth)



**1/4"**

Krom vanadyum, Krom kaplı, Polisajlı  
Chrom vanadium, Chrom plated, Polished

KOD CODE	L mm	g		TL/Ad.
1507 06 2110	110	100	5	495,00

**1507**

1/4" Mafsallı T Kol Cırcır Kolu Kolu (72 Diş)  
Swivel Head, T Handle Ratchet (72 Teeth)

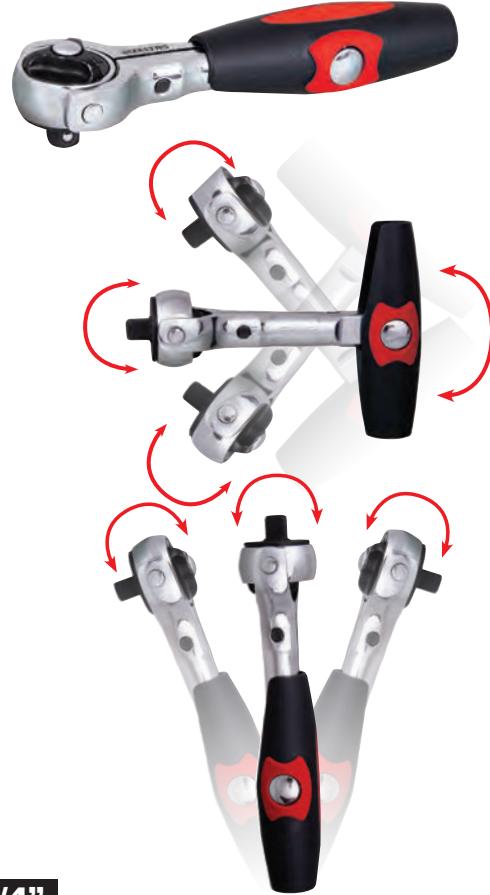

**1/4"**

Krom vanadyum, Krom kaplı, Polisajlı  
Chrom vanadium, Chrom plated, Polished

KOD CODE	L mm	g		TL/Ad.
1507 06 7115	115	110	5	757,75

**1507**

1/4" Lokma Adaptörü  
Adapter

TS ISO 3316  
DIN 3123

**1/4"**

Krom vanadyum, Krom kaplı, Polisajlı  
Chrom vanadium, Chrom plated, Polished

KOD CODE	inch	g		TL/Ad.
1507 06 0004	1/4"Fx3/8"M	20	5	30,75

**1507**

1/4" Derin Lokma Tornavida Adaptörü  
Spindle Handle

TS ISO 3315  
DIN 3122

**1/4"**

Krom vanadyum, Krom kaplı, Polisajlı, Selüloz Asetat Saplı  
Chrom vanadium, Chrom plated, Polished, Cellulose Acetate Handle

KOD CODE	L mm	L1 mm	g		TL/Ad.
1507 06 4080	150	65	100	10	70,75

**1107**

1/4" Bits Tutucu Lokma (Mıknatıslı)  
Bit Holder Socket

**1/4"**

Krom vanadyum  
Chrom vanadium

KOD CODE	Inch	g		TL/Ad.
1107 06 5010	1/4" F - 1/4" F	15	5	49,25

**1107**

1/4" Altı Köşe Lokma Anahtar Takımı (15 parça, mm)  
Socket Wrench Set 6 Points (15 pcs, mm)



**1/4"**

KOD CODE	LOKMA LAR Sockets	AVADANLIKLAR Accessories	g		TL/Ad.
1107 00 6015	4 - 5 - 6 7 - 8 - 9 - 10 11 - 12 - 13	<b>1/4" Cırcır kolu</b> Ratchet Handle	960	15	577,75
	<b>Altı Köşe</b> Six Points	<b>1/4" Mafsaf</b> Universal Joint			
		<b>1/4" T Kol</b> Sliding T Handle			
		<b>1/4" Ara Kol</b> Extension Bar 50 mm			
		<b>1/4" Ara Kol</b> Extension Bar 100 mm			

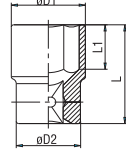

Havallı aletler ile kullanmayınız / Do not use with power-tools

**1110**
**3/8" Altı Köşe Lokma Anahtar (mm)**  
*Socket Wrench 6 Points (mm)*

 TS ISO 2725 - 1  
 DIN 3124

**3/8"**

 Krom vanadyum, Krom kaplı, Polisajlı  
*Chrom vanadium, Chrom plated, Polished*

KOD CODE	mm	Ø D1 mm	Ø D2 mm	L mm	L1 mm	g	TL/Ad.
1110 06 0006	6	9.8	17.8	27	9	25	10 33,75
1110 06 0007	7	10.8	17.8	27	9	25	10 33,75
1110 06 0008	8	12	17.8	27	9	25	10 33,75
1110 06 0009	9	13.2	17.8	27	9	25	10 33,75
1110 06 0010	10	14.5	17.8	27	9	25	10 33,75
1110 06 0011	11	15.8	17.8	27	9	30	10 33,75
1110 06 0012	12	16.8	17.8	27	9	30	10 33,75
1110 06 0013	13	17.8	16.8	27	9	30	10 36,00
1110 06 0014	14	19.6	17.5	29	11	35	10 36,00
1110 06 0015	15	20.8	18	29	11	45	10 36,00
1110 06 0016	16	21.8	19	29	11	45	10 37,50
1110 06 0017	17	23.4	20	29	11	55	10 37,50
1110 06 0018	18	24.7	21	29	13	60	10 39,00
1110 06 0019	19	25.8	22	29	13	65	10 45,00
1110 06 0021	21	27.8	24	32	13	80	10 50,75
1110 06 0022	22	29.7	26	32	15	85	10 54,25
1110 06 0023	23	29.7	26	32	15	90	10 54,25

**1110**
**3/8" Buji Lokma Anahtar (Lastikli)**  
*Spark Plug Socket with Rubber*

TS ISO 2725 - 1

**3/8"**

 Krom vanadyum, Krom kaplı, Polisajlı  
*Chrom vanadium, Chrom plated, Polished*

KOD CODE	mm	L mm	g	TL/Ad.
1110 06 9208	21	70	145	10 72,25

**1510**
**3/8" Cırcır Kolu**  
*Ratchet Handle*

 TS ISO 3315  
 DIN 3122

**3/8"**

 Krom vanadyum, Krom kaplı, Polisajlı  
*Chrom vanadium, Chrom plated, Polished*

KOD CODE	L mm	g	TL/Ad.
1510 06 0200	200	295	5 402,75

**1510**
**3/8" Ara Kol**  
*Extension Bar*

 TS ISO 3316  
 DIN 3123

**3/8"**

 Krom vanadyum, Krom kaplı, Polisajlı  
*Chrom vanadium, Chrom plated, Polished*

KOD CODE	L mm	g	TL/Ad.
1510 06 0075	75	75	5 61,25
1510 06 0150	150	145	5 92,50

**1510**
**3/8" Mafsal**  
*Universal Joint*

 TS ISO 3316  
 DIN 3123

**3/8"**

 Krom vanadyum, Krom kaplı, Polisajlı  
*Chrom vanadium, Chrom plated, Polished*

KOD CODE	L mm	g	TL/Ad.
1510 06 0056	56.5	60	5 99,25



## 1510

3/8" T Kol  
Sliding T - Handle

TS ISO 3315  
DIN 3122



## 1110

3/8" Altı Köşe Lokma Anahtar Takımı (19 parça, mm)  
6 Points Socket Wrench Set (19 Pcs, mm)



## 3/8"

Krom vanadyum, Krom kaplı, Polisajlı  
Chrom vanadium, Chrom plated, Polished



KOD CODE	L mm	g	TL/Ad.
1510 06 1200	200	180	5 142,75

## 3/8"

## 1510

3/8" Lokma Adaptörü  
Adapter

TS ISO 3316  
DIN 3123



## 3/8"

Krom vanadyum, Krom kaplı, Polisajlı  
Chrom vanadium, Chrom plated, Polished

KOD CODE	inch	g	TL/Ad.
1510 06 0007	3/8"Fx1/2"M	45	5 68,25

KOD CODE	LOKMALAR Sockets	AVADANLIKLAR Accessories	g	TL/Ad.
		<b>3/8" Cırcır Kolu</b> Ratchet Handle		
		<b>3/8" Mafsal</b> Universal Joint		
	6 - 7 - 8 - 9 10 - 11 - 12 13 - 14 - 17 19 - 21 - 23			
	<b>Altı Köşe</b> Six Points			
1110 00 6019	20.8	<b>3/8" T Kol</b> Sliding T Handle	1089	19 1.366,50
	<b>Buji Lokma</b> Lastikli <b>Altı Köşe</b> Spark Plug Socket With Rubber			
		<b>3/8" Ara Kol</b> Extension Bar 75 mm		
		<b>3/8" Ara Kol</b> Extension Bar 150 mm		

Havallı aletler ile kullanmayınız / Do not use with power-tools

### 1/2" Lokma Anahtar Sehпасı (145 Parça) Display Frame for Sockets (145 Pcs)



1/2"

KOD CODE	İÇERİK CONTENTS	g	TL/Ad.
1113 00 6145	<b>Dolu/Full</b> 10-11-12-13-14-15-16-17-18-19 10 adet /10 Pcs 21-22-23-24-26-27-28-30-32 5 Adet / 5 Pcs	18.236	1 10.098,50

## 1113

### 1/2" Altı Köşe Lokma Anahtar (mm) Socket Wrench 6 Points (mm)

TS ISO 2725 -1  
DIN 3124



1/2"

Krom vanadyum, Krom kaplı  
Chrom vanadium, Chrom plated

KOD CODE	mm	g D1 mm	g D2 mm	L mm	L1 mm	g	TL/Ad.
1113 06 1008	8	14	22	38	7	55	10 43,25
1113 06 1009	9	14.1	22	38	7	55	10 43,25
1113 06 1010	10	15.4	22	38	8	55	10 53,75
1113 06 1011	11	16.6	22	38	8	60	10 53,75
1113 06 1012	12	17.8	22	38	9	60	10 53,75
1113 06 1013	13	19	22	38	10	65	10 57,75
1113 06 1014	14	20.4	22	38	11	65	10 57,75
1113 06 1015	15	21.6	22	38	11	65	10 57,75
1113 06 1016	16	22.9	22	38	11	70	10 60,50
1113 06 1017	17	24	22	38	12	70	10 60,50
1113 06 1018	18	25.4	23	38	13	75	10 60,50
1113 06 1019	19	26.6	23	38	13	75	10 63,25
1113 06 1020	20	28	24	38	13	80	10 63,25
1113 06 1021	21	29.2	24	38	13	85	5 63,25
1113 06 1022	22	30.4	26	38	15	95	5 63,25
1113 06 1023	23	31.2	28	38	15	100	5 65,75
1113 06 1024	24	32.9	28	38	17	115	5 65,75
1113 06 1025	25	33.2	29	42	17	125	5 65,75
1113 06 1026	26	34	30	42	17	135	5 65,75
1113 06 1027	27	36.6	30	42	19	140	5 75,50
1113 06 1028	28	37.5	30	42	20	160	5 75,50
1113 06 1029	29	39.5	32	42	21	170	5 79,50
1113 06 1030	30	40	32	44	21	180	5 79,50
1113 06 1032	32	43	34	44	23	190	5 82,75

Havali aletler ile kullanmayınız / Do not use with power-tools

### 1000V 1/2" Altı Köşe Lokma Anahtar (mm) Socket Wrench 6 Points 1000V (mm)

TS ISO 2725 -1  
DIN 3124  
1000 V  
IEC 60900



1/2"

Krom vanadyum, Krom kaplı  
Chrom vanadium, Chrom plated

KOD CODE	mm	g D1 mm	g D2 mm	L mm	L1 mm	g	TL/Ad.
13000 005148	10	19,5	27	40	7	55	1 226,00
13000 005149	11	20,7	27	40	7	55	1 224,75
13000 005150	12	22	27	40	8	55	1 228,75
13000 005151	13	23,2	27	40	8	60	1 229,75
13000 005152	14	24,5	27	40	9	60	1 231,50
13000 005153	15	25,7	27	40	10	65	1 232,75
13000 005154	16	27	27	40	11	65	1 237,25
13000 005155	17	28,2	27	40	11	65	1 240,25
13000 005156	19	30,7	27	42	11	70	1 245,50
13000 005157	22	34,5	27	44	12	70	1 251,50
13000 005158	24	37	27	46	13	75	1 256,75
13000 005159	27	40,7	27	48	13	75	1 302,75



## 1114

### 1/2" On İki Köşe Lokma Anahtar (mm) Socket Wrench 12 Points (mm)

TS ISO 2725 - 1  
DIN 3124



1/2"

Krom vanadyum, Krom kaplı  
Chrom vanadium, Chrom plated

KOD CODE	Ø mm	Ø D1 mm	Ø D2 mm	L mm	L1 mm	g	TL/Ad.	
1114 06 1010	10	15	23.3	38	8	60	54,00	
1114 06 1011	11	16.4	23.3	38	8	60	54,00	
1114 06 1012	12	17.8	23.3	38	9	60	54,00	
1114 06 1013	13	19	23.3	38	10	60	58,25	
1114 06 1014	14	20.4	23.3	38	11	60	58,25	
1114 06 1015	15	21.6	23.3	38	11	65	58,25	
1114 06 1016	16	22.9	24	38	11	70	60,75	
1114 06 1017	17	24	22.5	38	12	70	60,75	
1114 06 1018	18	25.2	23	38	13	70	60,75	
1114 06 1019	19	26.8	23	38	13	75	63,75	
1114 06 1020	20	28	23	38	13	80	63,75	
1114 06 1021	21	29.2	23	38	13	80	5	63,75
1114 06 1022	22	30.2	24	40	15	95	5	63,75
1114 06 1023	23	31.4	25	40	15	100	5	66,25
1114 06 1024	24	32.6	26	42	17	105	5	66,25
1114 06 1026	26	35.3	28	42	17	135	5	74,50
1114 06 1027	27	36.6	28	42	19	135	5	85,25
1114 06 1028	28	37.8	30	42	20	155	5	85,25
1114 06 1030	30	40	30	44	21	165	5	89,50
1114 06 1032	32	42.5	30	44	23	180	5	93,75



Havali aletler ile kullanmayınız / Do not use with power-tools

## 1413

### 1/2" On İki Köşe Lokma Anahtar (SAE) Socket Wrench 12 Points (SAE)



1/2"

Krom vanadyum, Krom kaplı  
Chrom vanadium, Chrom plated

KOD CODE	Ø inch	Ø D1 mm	Ø D2 mm	L mm	L1 mm	g	TL/Ad.	
1413 06 1008	5/16"	13.2	21.8	37	6	45	10	63,00
1413 06 1095	3/8"	15	21.8	37	8	50	10	63,00
1413 06 1010	7/16"	16.4	23.3	37	9	60	10	65,25
1413 06 1011	15/32"	18	23.3	37	9	60	10	65,25
1413 06 1012	1/2"	19	23.3	37	9	60	10	68,00
1413 06 1013	9/16"	20.4	23.3	37	11	60	10	70,25
1413 06 1014	19/32"	21.6	23.3	37	11	65	10	70,25
1413 06 1015	5/8"	23.1	22	38	11	70	10	71,00
1413 06 1016	11/16"	24.5	22.5	38	11	70	10	73,50
1413 06 1017	3/4"	26.8	23	38	13	75	10	74,25
1413 06 1020	25/32"	28	23	38	13	75	10	76,75
1413 06 1021	13/16"	28.6	23	38	13	80	10	76,75
1413 06 1022	7/8"	30.2	24	40	15	90	5	76,75
1413 06 1024	15/16"	32.6	26	42	17	115	5	80,00
1413 06 1025	1"	35	28	42	17	130	5	80,00
1413 06 1027	1 1/16"	36.6	28	42	19	135	5	105,00
1413 06 1029	1 1/8"	38.8	30	42	19	170	5	105,00
1413 06 1030	1 3/16"	40	29.5	44	20	170	5	105,00
1413 06 1032	1 1/4"	42.5	30	44	22	185	5	105,00

## 1113

### 1/2" Buji Lokma Anahtar (Lastikli) Spark Plug Socket with Rubber



1/2"

Krom vanadyum, Krom kaplı, Polisajlı  
Chrom vanadium, Chrom plated, Polished

KOD CODE	Ø mm	L mm	g	TL/Ad.	
1113 06 9160	16	70	80	10	77,75
1113 06 9208	21	70	155	10	100,25

**1108**

**1/2" Altı Köşe Derin Lokma Anahtar (mm)**  
Deep Socket Wrench 6 Points (mm)

TS ISO 2725 - 1  
DIN 3124

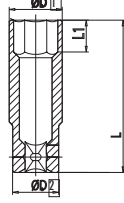

**1/2"**

**Krom vanadyum, Krom kaplı**  
Chrom vanadium, Chrom plated

KOD CODE	Ø mm	ØD1 mm	ØD2 mm	L mm	L1 mm	g	TL/Ad.
1108 06 0010	10	15,2	22	75	6	110	10 100,75
1108 06 0011	11	16,7	24	75	7	110	10 100,75
1108 06 0012	12	18	24	75	8	110	10 100,75
1108 06 0013	13	19	24	75	8	120	10 108,00
1108 06 0014	14	20,5	24	75	10	120	10 108,00
1108 06 0015	15	21,7	24	75	10	140	10 108,00
1108 06 0016	16	22	25,5	75	10	140	10 113,00
1108 06 0017	17	24	25,5	75	10	140	10 113,00
1108 06 0018	18	25,5	25,5	75	12	150	10 113,00
1108 06 0019	19	26	26,7	75	12	150	10 118,25

**1108**

**1/2" Altı Köşe Derin Lokma Anahtar Takımı (10 parça mm)**  
Deep Socket Set (10 pcs. mm)



**1/2"**

KOD CODE	İÇERİK CONTENTS	g	TL/Ad.
1108 00 6010	10-11-12-13-14-15 16-17-18-19	1290	10 1.083,50

**1113**

**1/2" Star (Torx®) Lokma Anahtar**  
Star Torx® Socket Wrench

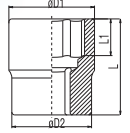

**1/2"**

**Krom vanadyum, Krom kaplı**  
Chrom vanadium, Chrom plated

KOD CODE	Ø D1 mm	Ø D2 mm	L mm	L1 mm	g	TL/Ad.	
1113 06 0210	E10	13.2	23.8	37	7.5	60	10 51,75
1113 06 0212	E12	15	23.8	37	9	65	10 51,75
1113 06 0214	E14	16.4	23.8	37	10	65	10 51,75
1113 06 0216	E16	18.8	23.8	37	11	70	10 51,75
1113 06 0218	E18	20.5	23.8	39	12.5	75	10 51,75
1113 06 0220	E20	23	23.8	39	14	75	10 58,25

**1113**

**1/2" Star (Torx®) Lokma Anahtar Takımı (7 Parça)**  
Star Torx® Socket Wrench Set (7 Pcs)



**1/2"**

KOD CODE	İÇERİK CONTENTS	g	TL/Ad.
1113 00 6007	Star Lokma / Star Socket E10 - E12 - E14 - E16 - E18 - E20 125 mm Ara Kol / Extension Bar	1075	7 430,50

## 1113

1/2" Lokmalı Allen Uç  
Hexagonal Bit Socket Wrench



1/2"

Krom vanadyum, Krom kaplı  
Chrom vanadium, Chrom plated

KOD CODE	mm	L mm	g		TL/Ad.
1113 06 1105	5	60	70	10	69,00
1113 06 1106	6	60	70	10	69,00
1113 06 1107	7	60	75	10	69,00
1113 06 1108	8	60	75	10	69,00
1113 06 1110	10	60	85	10	78,75
1113 06 1112	12	60	100	10	78,75
1113 06 1114	14	60	115	10	78,75
1113 06 4105	5	100	90	10	81,50
1113 06 4106	6	100	90	10	81,50
1113 06 4107	7	100	90	10	81,50
1113 06 4108	8	100	95	10	81,50
1113 06 4110	10	100	105	10	94,25
1113 06 4112	12	100	145	10	94,25
1113 06 4114	14	100	155	10	113,50
1113 06 4117	17	100	200	10	151,75

## 1113

1/2" Lokmalı Star (Torx®) Uç  
Star (Torx) Bit Socket Wrench



1/2"

Krom vanadyum, Krom kaplı  
Chrom vanadium, Chrom plated

KOD CODE	☆	L mm	g		TL/Ad.
1113 06 1220	T20	60	70	10	85,00
1113 06 1225	T25	60	70	10	85,00
1113 06 1227	T27	60	70	10	85,00
1113 06 1230	T30	60	70	10	85,00
1113 06 1240	T40	60	70	10	85,00
1113 06 1245	T45	60	70	10	85,00
1113 06 1250	T50	60	75	10	85,00
1113 06 1255	T55	60	80	10	85,00
1113 06 1260	T60	60	100	10	90,50
1113 06 4220	T20	100	78	10	96,25
1113 06 4225	T25	100	79	10	96,25
1113 06 4227	T27	100	80	10	96,25
1113 06 4230	T30	100	80	10	96,25
1113 06 4240	T40	100	80	10	96,25
1113 06 4245	T45	100	82	10	96,25
1113 06 4250	T50	100	82	10	96,25
1113 06 4255	T55	100	100	10	96,25
1113 06 4260	T60	100	134	10	99,75

## 1113

1/2" Lokmalı Allen Uç Takımı (60 mm, 7 Parça)  
Hexagonal Bits Socket Wrench Set (60 mm, 7 Pcs)

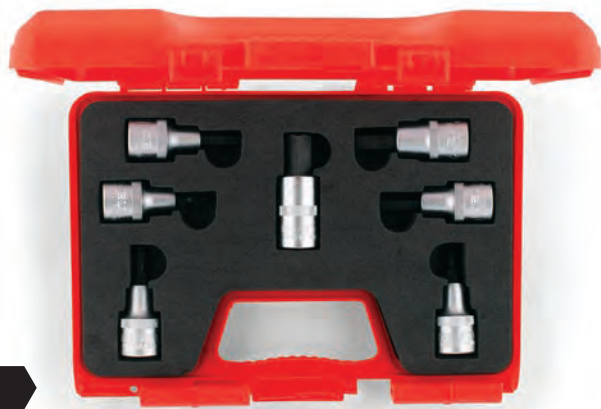

1/2"

KOD CODE	İÇERİK CONTENTS	g		TL/Ad.
1113 00 1107	Allen Uçlar 60mm Hex Bit Socket 5-6-7-8-10-12-14	1040	7	512,25

## 1113

1/2" Lokmalı Torx® Uç Takımı (60 mm, 9 parça)  
Torx® Bits Socket Wrench Set (60 mm, 9 Pcs)

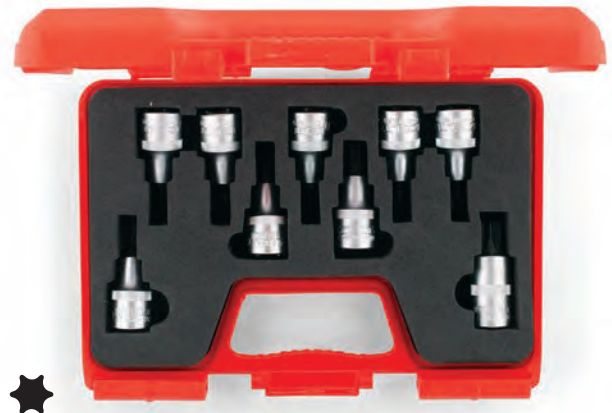

1/2"

KOD CODE	İÇERİK CONTENTS	g		TL/Ad.
1113 00 6009	Torx® Uçlar 60mm Star Socket T20 - T25 - T27 - T30 - T40 - T45 T50 - T55 - T60	1125	9	770,50

**1113 00 6017**

1/2" Lokmalı Allen Uç ve Star (Torx)® Uç Takımı (17 Parça)  
Hex Bit Sockets - Torx Bit Sockets Set (17 Pcs)



1/2"

KOD CODE	İÇERİK CONTENTS	g		TL/Ad.
1113	<b>T Kol (1/2")</b> Sliding T Handle			
1113	5 - 6 - 7 - 8 - 10 - 12 - 14 <b>Lokmalı Allen Uç</b> <b>60mm</b> Hex Bit Socket T20 - T25 - T27 T30 - T40		17	1.530,50
1113	<b>Lokmalı Star (Torx)</b> <b>Uç 60mm</b> Torx Bit Socket T45 - T50 - T55 - T60			

**1114**

1/2" On İki Köşe Lokmalı Bits Uç Yivli (XZN)  
Hex Bit Socket 12 Points (XZN)



1/2"

Krom vanadyum, Krom kaplı  
Chrom vanadium, Chrom plated

KOD CODE		L mm	g		TL/Ad.
1114 06 4005	M5	60	60	10	62,50
1114 06 4006	M6	60	62	10	62,50
1114 06 4008	M8	60	62	10	62,50
1114 06 4010	M10	60	78	10	62,50
1114 06 4012	M12	60	84	10	74,25
1114 06 4106	M6	80	69	10	79,00
1114 06 4108	M8	80	70	10	79,00
1114 06 4110	M10	80	84	10	87,00
1114 06 4112	M12	80	103	10	90,00
1114 06 4114	M14	80	133	10	96,25
1114 06 4208	M8	140	96	10	88,50
1114 06 4210	M10	140	125	10	108,50
1114 06 4212	M12	140	161	10	122,25
1114 06 4214	M14	140	210	10	137,25
1114 06 4216	M16	140	281	10	199,00

**1114**

1/2" Lokmalı (Ribe) Bits Uç  
Socket Wrench 6 Points



1/2"

Krom vanadyum, Krom kaplı  
Chrom vanadium, Chrom plated

KOD CODE		L mm	g		TL/Ad.
1114 06 5004	4	100	75	10	86,00
1114 06 5005	5	100	76	10	86,00
1114 06 5006	6	100	76	10	86,00
1114 06 5007	7	100	77	10	86,00
1114 06 5008	8	100	78	10	86,00
1114 06 5009	9	100	85	10	86,75
1114 06 5010	10	100	96	10	86,75
1114 06 5011	10.5	100	96	10	88,75
1114 06 5012	12	100	121	10	110,50
1114 06 5013	13	100	148	10	121,25
1114 06 5014	14	100	150	10	121,25
1114 06 5016	16	100	198	10	164,00

**1513**

1/2" Cırcır Kolu (32 Diş)  
Ratchet Handle

TS ISO 3315  
DIN3122



1/2"

Krom vanadyum, Krom kaplı  
Chrom vanadium, Chrom plated

KOD CODE	L mm	g		TL/Ad.
1513 06 0032	250	580	5	448,25

**13000 005277**

1000V 1/2" Cırcır Kolu  
Ratchet Handle 1000V

△ 1000 V  
IEC 60900

**YENİ  
NEW**



Krom vanadyum, Krom kaplı  
Chrom vanadium, Chrom plated

KOD CODE	L mm	g		TL/Ad.
13000 005277	275	540	1	2.184,25

## 1513

1/2" Ara Kol  
Extension Bar

TS ISO 3316  
DIN 3123



### 1/2"

Krom vanadyum, Krom kaplı  
Chrom vanadium, Chrom plated

KOD CODE	L mm	g		TL/Ad.
1513 06 4075	75	140	5	101,50
1513 06 4125	125	215	5	113,50
1513 06 4250	250	420	5	172,50

1000V 1/2" Ara Kol  
Extension Bar 1000V

TS ISO 3316  
DIN 3123



### 1/2"

Krom vanadyum, Krom kaplı  
Chrom vanadium, Chrom plated

KOD CODE	L mm	g		TL/Ad.
13000 005262	75	140	1	578,75
13000 005263	125	215	1	641,50
13000 005264	250	420	1	871,50

## 1513

1/2" T Kol Adaptörü  
Adapter



### 1/2"

Krom vanadyum, Krom kaplı  
Chrom vanadium, Chrom plated

KOD CODE	inch	g		TL/Ad.
1513 06 5250	3/8"Fx1/2"M	90	5	105,75

## 1513

1/2" T Kol  
Sliding T - Handle

TS ISO 3315  
DIN 3122



### 1/2"

Krom vanadyum, Krom kaplı  
Chrom vanadium, Chrom plated

KOD CODE	L mm	g		TL/Ad.
1513 06 2250	250	355	5	247,75

## 1513

1/2" Mafsal  
Universal Joint

TS ISO 3316  
DIN 3123



### 1/2"

Krom vanadyum, Krom kaplı  
Chrom vanadium, Chrom plated

KOD CODE	L mm	g		TL/Ad.
1513 06 4070	70	140	5	144,00

## 1513

1/2" Lokma Adaptörü  
Adapter

TS ISO 3316  
DIN 3123



### 1/2"

Krom vanadyum, Krom kaplı  
Chrom vanadium, Chrom plated

KOD CODE	inch	g		TL/Ad.
1513 06 0002	1/2"Fx3/8"M	55	5	53,00
1513 06 0003	1/2"Fx3/4"M	115	5	83,25

## 1113

1/2" Bits Tutucu Lokma  
Bit Holder Scket



### 1/2"

Krom vanadyum, Krom kaplı  
Chrom vanadium, Chrom plated

KOD CODE	Inch	g		TL/Ad.
1113 06 5010	1/2" F - 1/4" F	50	5	60,50

1/4" - 1/2" Altı Köşe Lokma Anahtar Takımı ( 35 Parça )  
Socket Wrench Set 6 Point 1/4" - 1/2" ( 35 Pcs)



KOD CODE	LOKMALAR Sockets	AVADANLIKLAR Accessories	g		TL/Ad.
1113 00 1038	4 - 5 - 6 7 - 8 - 9 - 10 11 - 12 - 13 <b>Altı Köşe</b> Six Points	<b>1/4" Cırcır kolu</b> Ratchet Handle  <b>1/4" Mafsal</b> Universal Joint  <b>1/4" T Kol</b> Sliding T Handle  <b>1/4" Ara Kol</b> Extension Bar 50 mm  <b>1/4" Ara Kol</b> Extension Bar 100 mm  <b>1/2" Cırcır Kolu</b> Ratchet Handle  <b>1/2" T Kol Adaptör</b> Sliding T Handle Adapter  <b>1/2" Ara Kol</b> Extension Bar 75 mm  <b>1/2" Ara Kol</b> Extension Bar 250 mm	4000	35	2.415,00



### 1113

1/2" Altı Köşe Lokma Anahtar Takımı (17 Parça, mm)  
Socket Wrench Set 6 Points (17 pcs, mm)



1/2"



KOD CODE	LOKMALAR Sockets	AVADANLIKLAR Accessories	g	TL/Ad.
1113 00 2017	10 - 11 - 12 13 - 14 - 15 17 - 19 - 22 24 - 27 - 30 32	<b>1/2" Cırcır Kolu</b> Ratchet Handle	2880	17
		<b>1/2" T Kol Adaptör</b> Sliding T Handle Adapter		
		<b>1/2" Mafsal</b> Universal Joint		
		<b>1/2" Ara Kol</b> Extension Bar 250 mm		
				1.695,50

### 1113

1/2" Altı Köşe Lokma Anahtar Takımı (24 Parça, mm)  
Socket Wrench Set 6 Points (24 pcs, mm)



1/2"



KOD CODE	LOKMALAR Sockets	AVADANLIKLAR Accessories	g	TL/Ad.
1113 00 2024	10 - 11 - 12 13 - 14 - 15 16 - 17 - 18 19 - 21 - 22 23 - 24 - 26 27 - 28 - 30 32	<b>1/2" Cırcır Kolu</b> Ratchet Handle	3650	24
		<b>1/2" Mafsal</b> Universal Joint		
		<b>1/2" T Kol Adaptör</b> Sliding T Handle Adapter		
		<b>1/2" Ara Kol</b> Extension Bar 125 mm		
		<b>1/2" Ara Kol</b> Extension Bar 250 mm		
				2.200,25

### 1114

1/2" On İki Köşe Lokma Anahtar Takımı (24 Parça, mm)  
Socket Wrench Set 12 Points (24 pcs, mm)



1/2"



KOD CODE	LOKMALAR Sockets	AVADANLIKLAR Accessories	g	TL/Ad.
1114 00 6024	10 - 11 - 12 13 - 14 - 15 16 - 17 - 18 19 - 21 - 22 23 - 24 - 26 27 - 28 - 30 32	<b>1/2" Cırcır Kolu</b> Ratchet Handle	4150	24
		<b>1/2" Mafsal</b> Universal Joint		
		<b>1/2" T Kol Adaptör</b> Sliding T Handle Adapter		
		<b>1/2" Ara Kol</b> Extension Bar 125 mm		
		<b>1/2" Ara Kol</b> Extension Bar 250 mm		
				2.255,00

### 1413

1/2" On İki Köşe Lokma Anahtar Takımı (24 parça, SAE)  
Socket Wrench Set 12 Points (24 pcs, SAE)



1/2"



KOD CODE	LOKMALAR Sockets	AVADANLIKLAR Accessories	g	TL/Ad.
1413 00 6024	5/16" - 3/8" 7/16" - 15/32" 1/2" - 9/16" 19/32" - 5/8" 11/16" - 3/4" 25/32" - 13/16" 7/8" - 15/16" 1" - 1 1/16" 1 1/8" - 1 3/16" 1 1/4"	<b>1/2" Cırcır Kolu</b> Ratchet Handle	4150	24
		<b>1/2" Mafsal</b> Universal Joint		
		<b>1/2" T Kol Adaptör</b> Sliding T Handle Adapter		
		<b>1/2" Ara Kol</b> Extension Bar 125 mm		
		<b>1/2" Ara Kol</b> Extension Bar 250 mm		
				2.478,00



## 1119

### 3/4" Altı Köşe Lokma Anahtar (mm) Socket Wrench 6 Points (mm)

TS ISO 2725 -1  
DIN 3124



**3/4"**

Krom vanadyum, Krom kaplı  
Chrom vanadium, Chrom plated

KOD CODE	mm	Ø D1 mm	Ø D2 mm	L mm	L1 mm	g	TL/Ad.
1119 06 1022	22	33	36	52	16	225	5 134,00
1119 06 1024	24	35	36	52	16	230	5 134,00
1119 06 1027	27	38	36	52	19	235	5 138,25
1119 06 1030	30	42	38	54	21	300	5 149,00
1119 06 1032	32	44	38	56	23	320	5 155,00
1119 06 1034	34	47	42	58	24	400	5 204,50
1119 06 1036	36	50	42	58	25	440	5 204,50
1119 06 1038	38	52	45	60	27	500	5 204,50
1119 06 1041	41	56	45	64	29	580	1 300,50
1119 06 1046	46	62	48	68	33	730	1 320,00
1119 06 1050	50	68	48	72	34	885	1 384,25
1119 06 1055	55	74	48	76	37	1070	1 489,25
1119 06 1060	60	80	48	78	38	1170	1 584,25

## 1419

### 3/4" On İki Köşe Lokma Anahtar (SAE) Socket Wrench 12 Points (SAE)



**3/4"**

Krom vanadyum, Krom kaplı  
Chrom vanadium, Chrom plated

KOD CODE	inch	Ø D1 mm	Ø D2 mm	L mm	L1 mm	g	TL/Ad.
1419 06 1022	7/8"	33	36	52	16	220	5 148,50
1419 06 1024	15/16"	35	36	52	16	220	5 148,50
1419 06 1025	1"	35	36	52	17	220	5 149,00
1419 06 1027	1 1/16"	38	36	52	19	225	5 153,00
1419 06 1028	1 1/8"	40	38	52	19	225	5 153,00
1419 06 1032	1 1/4"	44	38	56	23	315	5 171,50
1419 06 1033	1 5/16"	46	38	56	23	355	5 213,50
1419 06 1035	1 3/8"	48	42	58	25	400	5 213,50
1419 06 1036	1 7/16"	50	42	58	25	425	5 223,75
1419 06 1038	1 1/2"	52	45	60	27	475	5 223,75
1419 06 1041	1 5/8"	56	45	64	29	555	1 331,50
1419 06 1044	1 3/4"	60	47	66	31	660	1 349,75
1419 06 1046	1 13/16"	62	47	68	34	685	1 352,00
1419 06 1047	1 7/8"	64	48	70	34	730	1 422,25
1419 06 1050	2"	68	48	72	34	805	1 425,25

## 1120

### 3/4" On İki Köşe Lokma Anahtar (mm) Socket Wrench 12 Points (mm)

TS ISO 2725 - 1  
DIN 3124



**3/4"**

Krom vanadyum, Krom kaplı  
Chrom vanadium, Chrom plated

KOD CODE	mm	Ø D1 mm	Ø D2 mm	L mm	L1 mm	g	TL/Ad.
1120 06 1022	22	33	36	52	16	220	5 141,50
1120 06 1024	24	35	36	52	17	225	5 141,50
1120 06 1027	27	38	36	52	19	225	5 146,00
1120 06 1030	30	42	38	54	21	285	5 157,25
1120 06 1032	32	44	38	56	23	310	5 164,50
1120 06 1034	34	47	42	57	24	385	5 216,25
1120 06 1036	36	50	42	58	25	435	5 216,25
1120 06 1041	41	56	45	64	29	560	1 319,25
1120 06 1046	46	62	47	68	34	685	1 339,50
1120 06 1050	50	68	48	72	34	840	1 406,25

## 1519

### 3/4" Cırcır Kolu Ratchet Handle

TS ISO 3315  
DIN 3122



**3/4"**

Krom vanadyum, Krom kaplı  
Chrom vanadium, Chrom plated

KOD CODE	L mm	g	TL/Ad.
1519 06 4510	510	2230	5 1.329,00

## 1519

### 3/4" Ara Kol Extension Bar

TS ISO 3316  
DIN 3123



**3/4"**

Krom vanadyum, Krom kaplı  
Chrom vanadium, Chrom plated

KOD CODE	L mm	g	TL/Ad.
1519 06 4200	200	730	5 350,50
1519 06 4400	400	1370	5 634,75

Havallı aletler ile kullanmayınız / Do not use with power-tools

**1519**

**3/4" T Kol**  
Sliding T - Handle

TS ISO 3315  
DIN 3122



**3/4"**

Krom vanadyum, Krom kaplı  
Chrom vanadium, Chrom plated

KOD CODE	L mm	g		TL/Ad.
1519 06 4500	500	1485	5	706,25

**1519**

**3/4" Lokma Adaptörü**  
Adapter

TS ISO 3316  
DIN 3123



**3/4"**

Krom vanadyum, Krom kaplı  
Chrom vanadium, Chrom plated

KOD CODE	inch	g		TL/Ad.
1519 06 0008	3/4"Fx1/2"M	140	5	139,75
1519 06 0001	3/4"Fx1"M	300	5	189,00

**1119**

**3/4" Altı Köşe Lokma Anahtar Takımı (14 parça, mm)**  
Socket Wrench Set 6 Points (14 pcs, mm)



**3/4"**

**3/4"**

KOD CODE	LOKMALAR Sockets	AVADANLIKLAR Accessories	g		TL/Ad.
1119 00 6114	22 - 24 - 27 30 - 32 - 34 36 - 41 - 46 50	<b>3/4" Cırcır Kolu</b> Ratchet Handle	10180	14	5.144,50
		<b>3/4" T Kol</b> Sliding T Handle			
		<b>3/4" Ara Kol</b> Extension Bar 200 mm			
		<b>3/4" Ara Kol</b> Extension Bar 400 mm			

**1120**

**3/4" On İki Köşe Lokma Anahtar Takımı (14 parça, mm)**  
Socket Wrench Set 12 Points (14 pcs, mm)



**3/4"**

**3/4"**

KOD CODE	LOKMALAR Sockets	AVADANLIKLAR Accessories	g		TL/Ad.
1120 00 6014	22 - 24 - 27 30 - 32 - 34 36 - 41 - 46 50	<b>3/4" Cırcır Kolu</b> Ratchet Handle	13700	14	5.268,75
		<b>3/4" T Kol</b> Sliding T Handle			
		<b>3/4" Ara Kol</b> Extension Bar 200 mm			
		<b>3/4" Ara Kol</b> Extension Bar 400 mm			

**1419**

**3/4" On İki Köşe Lokma Anahtar Takımı (14 parça, SAE)**  
Socket Wrench Set 12 Points (14 pcs, SAE)



**3/4"**

**3/4"**

KOD CODE	LOKMALAR Sockets	AVADANLIKLAR Accessories	g		TL/Ad.
1419 00 6114	15/16" - 1 1/16" 1 1/8" - 1 1/4" 1 5/16" 1 3/8" 1 1/2" - 1 5/8" 1 7/8" - 2"	<b>3/4" Cırcır Kolu</b> Ratchet Handle	10180	14	5.476,25
		<b>3/4" T Kol</b> Sliding T Handle			
		<b>3/4" Ara Kol</b> Extension Bar 200 mm			
		<b>3/4" Ara Kol</b> Extension Bar 400 mm			

## 1225

1" On İki Köşe Lokma Anahtar (mm)  
Socket Wrench 12 Points (mm)

TS ISO 2727-1  
DIN 3124

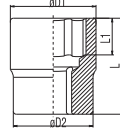

1"

Krom vanadyum, Krom kaplı  
Chrom vanadium, Chrom plated

KOD CODE	mm	Ø D1 mm	Ø D2 mm	L mm	L1 mm	g	TL/Ad.
1225 06 0036	36	52	48	65	26	525	1 419,00
1225 06 0041	41	58	50	70	29	665	1 456,00
1225 06 0046	46	65	54	75	32	900	1 553,00
1225 06 0050	50	70	57	75	34	1040	1 655,00
1225 06 0055	55	76	57	83	42	1250	1 838,75
1225 06 0060	60	82	60	87	46	1505	1 1.090,25

## 1113

1/2" Alaşımli Jant Lokma Takımı (3 Parca, mm)  
Combination Lug Nut Socket Set (3 Pcs, mm)



1/2"

KOD CODE	LOKMALAR Sockets	g	TL/Ad.
1113 00 9003	17 -19 - 21	800	3 705,75

## 1525

1" Lokma Adaptörü  
Adapter

TS ISO 3316  
DIN 3123



1"

Krom vanadyum, Krom kaplı  
Chrom vanadium, Chrom plated

KOD CODE	inch	g	TL/Ad.
1525 06 0005	1"Fx3/4"M	330	5 269,50



**1113**

1/2" Altı Köşe Havalı Lokma Anahtar (mm)  
Impact Socket Wrench 6 Points (mm)

TS ISO 2725-2



İZELTAŞ YOUTUBE

**1/2"**

Krom molibden, Fosfat kaplamalı  
Chrom molybdenum, Phosphate finish

KOD CODE	mm	Ø D1 mm	Ø D2 mm	L mm	L1 mm	g	TL/Ad.
1113 06 7010	10	17	25	38	8	70	10
1113 06 7011	11	18	25	38	8	70	10
1113 06 7012	12	19	25	38	9	70	10
1113 06 7013	13	20	25	38	10	70	10
1113 06 7014	14	22	25	38	10	75	10
1113 06 7015	15	23	30	38	11	110	10
1113 06 7016	16	24	30	38	11	110	10
1113 06 7017	17	26	30	38	12	115	10
1113 06 7018	18	27	30	38	13	115	10
1113 06 7019	19	28	30	38	13	120	10
1113 06 7021	21	30	30	40	14	125	5
1113 06 7022	22	32	30	40	14	145	5
1113 06 7024	24	34	30	42	15	150	5
1113 06 7027	27	38	30	44	16	175	5

**1513**

1/2" Havalı Lokma Ara Kol  
Impact Socket Extension Bar

**1/2"**

Krom molibden, Fosfat kaplamalı  
Chrom molybdenum, Phosphate finish

KOD CODE	L mm	g	TL/Ad.
1513 06 7125	125	275	5

**1108**

1/2" Altı Köşe Havalı Derin Lokma Anahtar (mm)  
6 Point Impact Socket Wrench, Long Type (mm)

**1/2"**

Krom molibden, Fosfat kaplamalı  
Chrom molybdenum, Phosphate finish

KOD CODE	mm	L mm	g	TL/Ad.
1108 06 7010	10	80	136	10
1108 06 7011	11	80	144	10
1108 06 7012	12	80	157	10
1108 06 7013	13	80	157	10
1108 06 7014	14	80	172	10
1108 06 7015	15	80	223	10
1108 06 7016	16	80	230	10
1108 06 7017	17	80	240	10
1108 06 7018	18	80	255	10
1108 06 7019	19	80	236	10
1108 06 7021	21	80	240	10
1108 06 7022	22	80	296	5
1108 06 7024	24	80	308	5
1108 06 7027	27	80	356	5
1108 06 7030	30	80	416	5
1108 06 7032	32	80	510	5

**1513**

1/2" Havalı Lokma Adaptörü  
Impact Socket Adapter

**1/2"**

Krom molibden, Fosfat kaplamalı  
Chrom molybdenum, Phosphate finish

KOD CODE	inch	g	TL/Ad.
1513 06 7002	1/2"Fx3/8"M	95	5
1513 06 7003	1/2"Fx3/4"M	175	5

**1513**

1/2" Havalı Lokma Mafsal  
Impact Socket Universal Joint

**1/2"**

Krom molibden, Fosfat kaplamalı  
Chrom molybdenum, Phosphate finish

KOD CODE	L mm	g	TL/Ad.
1513 06 7075	75	220	5

## 1119

### 3/4" Altı Köşe Havalı Lokma Anahtar (mm) Impact Socket Wrench 6 Points (mm)



**3/4"**

Krom molibden, Fosfat kaplamalı  
Chrom molybdenum, Phosphate finish

KOD CODE	mm	ø D1 mm	ø D2 mm	L mm	L1 mm	g	TL/Ad.
1119 06 7019	19	32	44	50	13	330	5 206,75
1119 06 7021	21	35	44	50	15	340	5 206,75
1119 06 7022	22	36	44	50	15	345	5 206,75
1119 06 7024	24	38	44	50	16	350	5 206,75
1119 06 7027	27	42	44	53	17	380	5 212,75
1119 06 7030	30	46	44	53	20	410	1 229,25
1119 06 7032	32	48	44	57	20	460	1 229,25
1119 06 7034	34	51	44	57	22	490	1 298,75
1119 06 7036	36	53	44	57	22	520	1 298,75
1119 06 7041	41	59	44	58	24	580	1 461,00
1119 06 7046	46	66	44	62	24	715	1 490,00

## 1519

### 3/4" Havalı Lokma Ara Kol Impact Socket Extension Bar



**3/4"**

Krom molibden, Fosfat kaplamalı  
Chrom molybdenum, Phosphate finish

KOD CODE	L mm	g	TL/Ad.
1519 06 7175	175	865	5 509,25
1519 06 7250	250	1155	5 728,25
1519 06 7330	330	1425	5 1.105,25

## 1519

### 3/4" Havalı Lokma Mafsal Impact Socket Universal Joint



**3/4"**

Krom molibden, Fosfat kaplamalı  
Chrom molybdenum, Phosphate finish

KOD CODE	L mm	g	TL/Ad.
1519 06 7108	108	735	5 848,25

## 1519

### 3/4" Havalı Lokma Adaptörü Impact Socket Adapter



**3/4"**

Krom molibden, Fosfat kaplamalı  
Chrom molybdenum, Phosphate finish

KOD CODE	inch	g	TL/Ad.
1519 06 7011	3/4"Fx1/2" M	315	5 294,00



**1125**
**1" Altı Köşe Havalı Lokma Anahtar (mm)**  
*Impact Socket Wrench 6 Points (mm)*

**1"**
**Krom molibden, Fosfat kaplamalı**  
*Chrom molybdenum, Phosphate finish*

KOD CODE	mm	Ø D1 mm	Ø D2 mm	L mm	L1 mm	g		TL/Ad.
1125 06 7024	24	41	54	58	17	560	1	372,25
1125 06 7027	27	44	54	58	19	565	1	375,50
1125 06 7030	30	48	54	60	21	605	1	378,75
1125 06 7032	32	51	54	62	21	650	1	383,25
1125 06 7033	33	52	54	62	21	660	1	383,25
1125 06 7034	34	53	54	62	24	765	1	385,25
1125 06 7036	36	56	54	65	24	720	1	387,00
1125 06 7038	38	58	54	65	26	735	1	403,00
1125 06 7041	41	61	54	70	28	845	1	491,00
1125 06 7046	46	68	54	75	30	1075	1	541,75
1125 06 7050	50	73	54	75	32	1170	1	577,75
1125 06 7055	55	79	54	83	37	1435	1	766,00
1125 06 7060	60	86	54	87	37	1760	1	957,50

**1525**
**1" Havalı Lokma Mafsal**  
*Impact Socket Universal Joint*

**1"**
**Krom molibden, Fosfat kaplamalı**  
*Chrom molybdenum, Phosphate finish*

KOD CODE	L mm	g		TL/Ad.
1525 06 7128	128	1530	1	1.732,25

**1525**
**1" Havalı Lokma Ara Kol**  
*Impact Socket Extension Bar*

**1"**
**Krom molibden, Fosfat kaplamalı**  
*Chrom molybdenum, Phosphate finish*

KOD CODE	L mm	g		TL/Ad.
1525 06 7175	175	1395	5	929,00
1525 06 7250	250	1890	5	1.193,75
1525 06 7330	330	2455	5	1.451,25

**1525**
**1" Havalı Lokma Adaptörü**  
*Impact Socket Adapter*

**1"**
**Krom molibden, Fosfat kaplamalı**  
*Chrom molybdenum, Phosphate finish*

KOD CODE	inch	g		TL/Ad.
1525 06 7015	1"Fx3/4"M	560	5	355,50





## 1800

### Kovan Anahtar İki Ağız (mm) Double Ended Tubular Socket Wrench (mm)

TS ISO 3793  
DIN 896

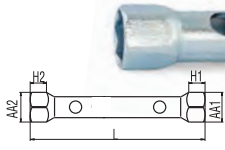

Dikişsiz çelik boru, Çinko kaplı  
Seamless steel tube, Zinc plated

KOD CODE	mm	L mm	AA1 mm	AA2 mm	H1 mm	H2 mm	g		TL/Ad.
1800 07 0607	6x7	105	8.6	9.6	7	8	25	5	62,25
1800 07 0809	8x9	105	11.2	12.2	9	10	35	5	68,25
1800 07 1011	10x11	120	13.6	14.6	11	11.5	55	5	93,50
1800 07 1213	12x13	135	16	17	12	12.5	80	5	99,25
1800 07 1415	14x15	135	18.5	19.5	13	13.5	110	5	108,75
1800 07 1617	16x17	150	21	22	14	14.5	150	5	116,75
1800 07 1819	18x19	150	23	24	15	15.5	170	5	121,00
1800 07 2022	20x22	165	25.4	27.4	16	18	220	5	133,25
1800 07 2224	22x24	180	27.4	29.4	18	20	330	5	149,75
1800 07 2427	24x27	180	30.4	33.4	20	23	400	5	193,50

## 1800

### Kovan Anahtar Takımı İki Ağız (mil dahil, mm) Double Ended Tubular Socket Wrench Set with Tommy Bars (mm)

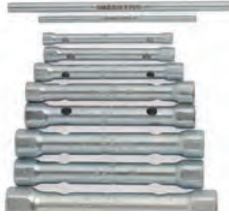

KOD CODE	mm	g		TL/Ad.
1800 00 2108	6x7 - 8x9 - 10x11 - 12x13 - 14x15 16x17 - 18x19 - 20x22 Mil/Handle Bars 5x125-8x180 mm	920	10	865,00

## 1841

### Kovan Anahtar Bir Ağız (mil dahil) Single Ended Tubular Socket Wrench with Tommy Bar



Dikişsiz çelik boru, Çinko kaplı  
Seamless steel tube, Zinc plated

KOD CODE	mm		L mm	ØD mm	Mil Handle bar mm	g		TL/Ad.
	mm	inch						
1841 07 0021	21	13/16"	120	20	10x120	215	5	103,50

## 1850

### Kovan Anahtar Mili Tommy Bar

TS ISO 3793  
DIN 900



KOD CODE	ØDxL mm	g		TL/Ad.
1850 07 5125	5x125	20	10	24,50
1850 07 8180	8x180	70	10	37,50
1850 07 1120	10x120	75	10	42,50
1850 07 1200	10x200	120	10	48,00

## 1870

### Ağır Tip Bijon Anahtarı İki Ağız Uzun Double Ended Rim Wrench (long)

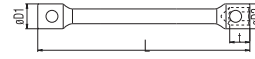

Yüksek alaşımlı çelik, Nikel kaplı  
Special steel, Nickel plated

KOD CODE	mm	L mm	t mm	ØD1 mm	ØD2 mm	g		TL/Ad.
1870 09 2427	24x27	400	34.5	36	40	1135	10	264,50
1870 09 2730	27x30	400	34.5	40	44	1380	10	303,75
1870 09 2732	27x32	400	34.5	40	46	1380	10	303,75
1870 09 3032	30x32	400	34.5	44	46	1380	10	314,25
1870 09 3233	32x33	400	34.5	46	47	1450	10	348,75

## 1874

### Ağır Tip Bijon Anahtarı İki Ağız Kısa Double Ended Rim Wrench (short)

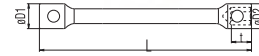

Yüksek alaşımlı çelik, Nikel kaplı  
Special steel, Nickel plated

KOD CODE	mm	L mm	t mm	ØD1 mm	ØD2 mm	g		TL/Ad.
1874 09 2224	22x24	170	34.5	34	36	720	10	167,50
1874 09 2427	24x27	200	34.5	36	40	800	10	214,00

## 1850

### Bijon Anahtar Mili Tommy Bar

TS ISO 3793  
DIN 900

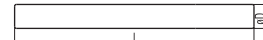

KOD CODE	ØDxL mm	g		TL/Ad.
1850 09 1630	18x630	1260	1	154,00

**1975**

**Bijon Anahtarı İstavroz Tipi**  
*Cross Rim Wrench*

TS ISO 6788

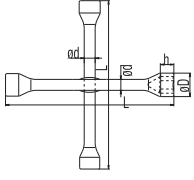

**Yüksek alaşımli çelik, Krom kaplı**  
*Special steel, Chrom plated*

KOD CODE	mm	inch	σD mm	h mm	L mm	σd mm	g	TL/Ad.
	17	11/16"	28	17				
1975 09 1719	19	3/4"	30	18.5	420	16	1422	10 327,00
	21	13/16"	32	19.5				
	22	7/8"	34	20.5				

**1975**

**1/2" Adaptörlü Bijon Anahtarı İstavroz Tipi**  
*Cross Rim Wrench (with 1/2" adapter)*

TS ISO 6788

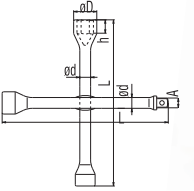

**Yüksek alaşımli çelik, Krom kaplı**  
*Special steel, Chrom plated*

KOD CODE	mm	inch	σD mm	h mm	L mm	A mm	σd mm	g	TL/Ad.
	17	11/16"	28	17					
1975 09 1322	19	3/4"	30	18.5	420	12.65	16	1375	10 328,50
	22	7/8"	34	20.5					
		1/2"							

**1940**

**Bijon Anahtarı Pipo Tipi (Tornavida Ağzılı)**  
*Offset Socket Wrench with Screwdriver*

TSEK

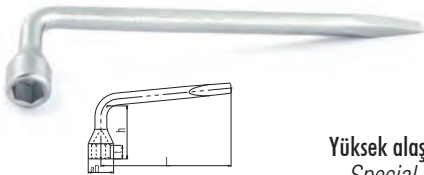

**Yüksek alaşımli çelik, Krom kaplı**  
*Special steel, Chrom plated*

KOD CODE	mm	inch	L mm	σD mm	h mm	g	TL/Ad.
1940 09 0017	17	11/16"	285	28	65	485	10 164,25
1940 09 0019	19	3/4"	285	30	65	470	10 173,50
1940 09 0021	21	13/16"	320	32	85	575	10 187,50

**1840**

**1/2" Mafsallı T Kol**  
*Swivel Handle With Sliding T 1/2"*

**Özel alaşım çelik, Krom kaplı**  
*Special steel, Chrom plated*

**1/2"**

KOD CODE	mm	L mm	g	TL/Ad.
1840 08 0500	1/2"	600	740	10 671,00

**1855**

**Mafsallı T Kol Lokma**  
*T - Handle Wrench with Universal Joint*

**Özel alaşım çelik, Krom kaplı**  
*Special steel, Chrom plated*

KOD CODE	mm	L mm	g	TL/Ad.
1855 08 0008	8	400	225	10 711,50
1855 08 0010	10	450	405	10 865,00
1855 08 0012	12	450	410	10 865,00
1855 08 0013	13	450	425	10 865,00
1855 08 0017	17	500	485	10 963,50
1855 08 0019	19	510	895	10 1.224,75



## 1610

3/8" Tork Anahtarı  
Torque Wrench

TS EN ISO 6789-1  
TS EN ISO 6789-2



### 3/8"

KOD CODE	ÖLÇÜ SIZE	L mm	g	TL/Ad.
1610 06 0100	2.5 - 11 Nm - 0.3 - 1.2 Kg	310	515	1 3.714,50
1610 06 0300	7 - 33 Nm - 0.5 - 3.4 Kg	425	640	1 3.840,25

## 1613

1/2" Tork Anahtarı  
Torque Wrench

TS EN ISO 6789-1  
TS EN ISO 6789-2



### 1/2"

KOD CODE	ÖLÇÜ SIZE	L mm	g	TL/Ad.
1613 06 1200	25 - 135 Nm - 3 - 14 Kg	550	1430	1 3.965,75
1613 06 2000	50 - 225 Nm - 5 - 23 Kg	600	2165	1 4.093,50
1613 06 3000	70 - 330 Nm - 7 - 35 Kg	830	2870	1 4.981,00

## 1619

3/4" Tork Anahtarı  
Torque Wrench

TS EN ISO 6789-1  
TS EN ISO 6789-2



İZELTAS USTA İŞİ  
SOHBETLER

### 3/4"

KOD CODE	ÖLÇÜ SIZE	L mm	g	TL/Ad.
1619 06 2080	200 - 800 Nm - 22 - 82 kg	1030	8860	1 15.349,25

## 1607

1/4" Cırcırlı Tork Anahtar  
Torque Wrench With Reversible Ratchet-Head

TS EN ISO 6789-1  
TS EN ISO 6789-2



İZELTAS YOUTUBE

### 1/4"

KOD CODE	ÖLÇÜ SIZE	L mm	g	TL/Ad.
1607 06 0420	4 - 20 Nm	320	640	1 2.940,25

## 1610

3/8" Cırcırlı Tork Anahtar  
Torque Wrench With Reversible Ratchet-Head

TS EN ISO 6789-1  
TS EN ISO 6789-2



### 3/8"

KOD CODE	ÖLÇÜ SIZE	L mm	g	TL/Ad.
1610 06 2010	20 - 100 Nm	435	1300	1 3.319,75

## 1613

1/2" Cırcırlı Tork Anahtar  
Torque Wrench With Reversible Ratchet-Head

TS EN ISO 6789-1  
TS EN ISO 6789-2



### 1/2"

KOD CODE	ÖLÇÜ SIZE	L mm	g	TL/Ad.
1613 06 4020	40 - 200 Nm	520	1590	1 3.888,50
1613 06 6034	60 - 340 Nm	610	1810	1 4.076,75

## 1619

3/4" Cırcırlı Tork Anahtar  
Torque Wrench With Reversible Ratchet-Head

TS EN ISO 6789-1  
TS EN ISO 6789-2



### 3/4"

KOD CODE	ÖLÇÜ SIZE	L mm	g	TL/Ad.
1619 06 1060	100 - 600 Nm	1050	5600	1 10.782,00

**1/2" CIRCIR KOL / RATCHET HANDLE**

Lokmayı salmayan bilya tasarımı  
(kare adaptörlü bilyalı tasarım)  
Square adaptor with ball design to lock sockets

Değiştirilebilir iç mekanizma  
Inter-changeable inner mechanism

Yüksek dayanım için  
güçlü 32 diş  
32 teeth for high  
endurance

Çift yönlü kullanım  
sağlayan mandal tasarımı  
Bi-directional latch design

Yüksek mukavemetli  
alaşımli sıcak dövme çeliği  
High strength alloyed cold work tool steel

Nikel üzerine krom  
kaplama ile korozyon  
direncinde üst seviye koruma  
High corrosion resistance with chrome over  
nickel plating

Dayanımı yüksek sert plastikten ve  
konforlu tutuş sağlayan yumuşak  
elastomer malzemeden imal edilmiş çift  
komponentli ergonomik sap  
Two component ergonomic handle with high strength and soft  
grip plastic



İZELTAS USTA İŞİ  
SOHBETLER



İZELTAS YOUTUBE

**İZELTAS®**

# BORU ANAHTARLARI VE PENSELER

PIPE WRENCHES AND PLIERS

Boru Anahtarları  
Pipe Wrenches

Fort Penseler  
Water Pump Pliers

Ayarlı Penseler  
Grip Wrenches

Penseler  
Pliers

Kargaburunlar  
Nose Pliers

Kerpetenler  
Carpenter Pincers

Elektronikçi Penseler  
Electronic Pliers



İZELTAS YOUTUBE

PIPE WRENCHES  
AND PLIERS

BORU  
ANAHTARLARI  
PENSELER

**KOMBİNE PENSE KRAFT SERİ/COMBINATION PLIERS**

Güçlü kavrama sağlayan  
tırnaklı tutma yüzeyleri  
Toothed surface for strong grip

Isıl işlem sonrasında indüksiyonda  
sertleştirme ile kullanım ömrü  
artırılmış kesici ağızlar  
Heat-treated and induction hardened cutting edges for long  
lifetime

Nikel üzerine krom kaplama ile  
korozyon direncinde  
üst seviye koruma  
High corrosion resistance  
with chrome over nickel plating

Yüksek karbonlu  
sıcak dövme  
çeliği ile artırılmış  
dayanım  
High carbon forged steel for  
improved durability

Düşmelere ve darbeye dayanıklı,  
selüloz asetat ergonomik sap  
Impact resistant cellulose acetate handle

## 2100

### Stilson Boru Anahtarı Pipe Wrench, Stilson





TS 3796



 Yedek parça sayfa 202  
Spare parts page 202

Krom vanadyum, Dişler indüksiyonda sertleştirilmiş, Elektrostatik boyanmış  
Chrom vanadium, Teeth induction hardened, Electrostatically painted

KOD CODE	L mm	L inch	 mm	ÖLÇÜ SIZE Inch	 g		TL/Ad.
2100 10 0008	200	8"	27	3/4"	280	1	414,50
2100 10 0010	250	10"	34	1"	550	1	498,50
2100 10 0012	300	12"	42	1 1/4"	725	1	561,00
2100 10 0014	350	14"	50	1 1/2"	1030	1	688,50
2100 10 0018	450	18"	60	2"	1775	1	874,00
2100 10 0024	600	24"	76	2 1/2"	2775	1	1.408,00



## 2110

### Ağır Tip Boru Anahtarı Pipe Wrench, Heavy Duty



 Yedek parça sayfa 202  
Spare parts page 202

Krom vanadyum, Dişler indüksiyonda sertleştirilmiş, Elektrostatik boyanmış  
Chrom vanadium, Teeth induction hardened, Electrostatically painted

KOD CODE	L mm	L inch	 mm	ÖLÇÜ SIZE Inch	 g		TL/Ad.
2110 10 0008	200	8"	34	1"	425	1	550,50
2110 10 0010	250	10"	42	1 1/4"	795	1	683,25
2110 10 0012	300	12"	50	1 1/2"	1245	1	782,50
2110 10 0014	350	14"	60	2"	1710	1	911,00
2110 10 0018	450	18"	75	2 1/2"	2685	1	1.271,00
2110 10 0024	600	24"	90	3"	4370	1	2.049,50
2110 10 0036	900	36"	140	5"	7600	1	4.539,25
2110 10 0048	1200	48"	165	6"	15600	1	9.297,00

## 2201

### Maşalı Boru Anahtarı (85°) Pipe Wrench (85°)





TS 3796  
DIN 5234



 Yedek parça sayfa 202  
Spare parts page 202

Krom vanadyum, Dişler indüksiyonda sertleştirilmiş, Elektrostatik boyanmış  
Chrom vanadium, Teeth induction hardened, Electrostatically painted

KOD CODE	L mm	 mm	ÖLÇÜ SIZE Inch	 g		TL/Ad.
2201 10 0010	325	40	1"	870	1	422,00
2201 10 0015	430	60	1 1/2"	1585	1	653,50
2201 10 0020	585	70	2"	2700	1	978,50
2201 10 0030	690	100	3"	4270	1	1.483,50
2201 10 0040	760	130	4"	5800	1	2.224,75

**Üniversal Fort Pense**  
*Waterpump Pliers Universal*TS 60 TS ISO 8976  
DIN ISO 8976

İZELTAŞ YOUTUBE

**Krom vanadyum, Krom kaplı, PVC izoleli**  
*Chrom vanadium, Chrom plated, PVC insulated*

KOD CODE	L mm	L inch	mm	g	TL/Ad.	
2400 11 0160	160	6 1/4"	30	125	5	258,50
2400 11 0240	240	9 1/2"	35	355	5	361,50
2400 11 0315	315	12 1/2"	40	530	5	592,00

**1000V İzoleli Üniversal Fort Pense**  
*Insulated Type Waterpump Pliers Universal 1000V*TS 60  
TS ISO 8976**Krom vanadyum, Krom kaplı, çift komponent saplı**  
*Chrom vanadium, Chrom plated, Two component handle*

KOD CODE	L mm	L inch	mm	g	TL/Ad.	
2400 11 6240	240	9 1/2"	35	370	5	419,25

**Yaylı Fort Pense**  
*Waterpump Pliers With Spring*İZELTAŞ USTA İŞİ  
SOHBETLER**Krom vanadyum, Karartma, PVC izoleli**  
*Chrom vanadium, Black finish, PVC insulated*

KOD CODE	L mm	L inch	mm	g	TL/Ad.	
2415 11 0240	240	9 1/2"	35	365	5	487,50





## 2500

### Üniversal Ayarlı Pense Universal Grip



Çeneler krom vanadyum çeliğinden dövülmüştür, Nikel kaplama,  
Kullanım sahası: Yuvarlak ve düz malzemeler  
Jaws Chrom vanadium forged, Nickel plated  
Application field : Flat and round materials

KOD CODE	L mm	L inch	mm	g		TL/Ad.
2500 11 0250	250	10"	30	560	5	430,50

## 2510

### Spesiyal Ayarlı Pense Special Grip



Çeneler krom vanadyum çeliğinden dövülmüştür, Nikel kaplama,  
Kullanım sahası: Yuvarlak ve düz malzemeler  
Jaws Chrom vanadium forged, Nickel plated  
Application field: Flat and round materials

KOD CODE	L mm	L inch	mm	g		TL/Ad.
2510 11 0250	250	10"	30	550	5	430,50

## 2505

### Standart Ayarlı Pense Standard Grip

TSEK



Çeneler krom vanadyum çeliğinden dövülmüştür, Nikel kaplama  
Kullanım sahası: Düz malzemeler  
Jaws, Chrom vanadium forged, Nickel plated  
Application field: Flat materials

KOD CODE	L mm	L inch	mm	g		TL/Ad.
2505 11 0250	250	10"	30	535	5	430,50

## 2511

### C tipi Ayarlı Pense Clamp Grip C-type



Çeneler krom vanadyum çeliğinden dövülmüştür, Nikel kaplama,  
Kullanım sahası: Ağılı profillerin tutulmasında  
Jaws Chrom vanadium forged, Nickel plated  
Application field: For Gripping angled sheet metal

KOD CODE	L mm	L inch	mm	g		TL/Ad.
2511 11 0280	280	11"	70	700	1	719,75

**Kaynakçı Ayarlı Pense (Düz Ağız)**  
*Lock Grip With Flat Jaws*

Özel alaşımli çelikten imal edilmiş, Nikel kaplama,  
Kullanım sahası: 80 mm düz çeneleri ile kıvrık metal levhaları  
*Made from special alloy steel, Nickel plated,*  
*Application field: Gripping sheet metals with 80 mm Flat jaws*

KOD CODE	L mm	L inch	 mm	 g		TL/Ad.
2512 11 0200	200	8"	30	485	1	726,25

**Kaportacı Ayarlı Pense**  
*Welding Grip*

Özel alaşımli çelikten imal edilmiş- Nikel kaplama,  
Kullanım sahası: Yassı ve köşeli malzemelerde  
*Made from special alloy steel, Nickel plated*  
*Application field : Angled corners and edges*

KOD CODE	L mm	L inch	 mm	 g		TL/Ad.
2515 11 0270	270	10 5/8"	50	765	1	576,50

**Kaynakçı Ayarlı Pense (Boru İçin)**  
*Grip For Tubes*

Özel alaşımli çelikten imal edilmiş, Nikel kaplama,  
Kullanım sahası: Boru malzemeler  
*Made from special alloy steel, Nickel plated,*  
*Application field: Tubes*

KOD CODE	L mm	L inch	 mm	 g		TL/Ad.
2513 11 0280	280	11"	50	800	1	726,25

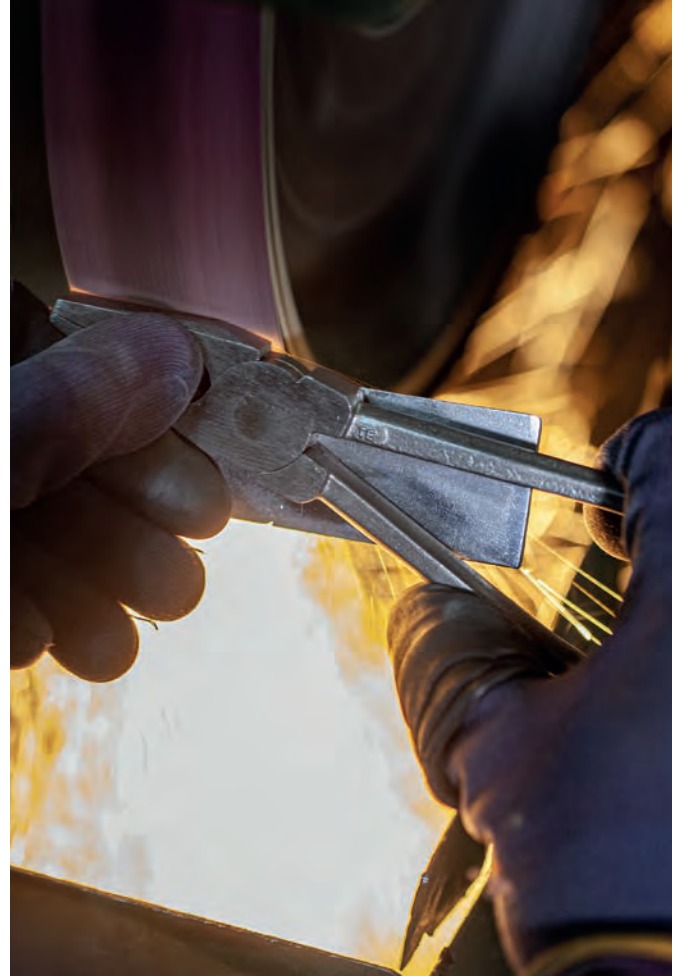

**3020****Kombine Pense Opak Seri**  
*Combination Pliers*TS 60  
TS ISO 5746  
DIN ISO 5746

İZELTAŞ YOUTUBE

Özel alaşımli çelik, Kesici ağızlar indüksiyonda sertleştirilmiş  
*Special steel, Cutters induction hardened*

KOD CODE	L mm	L inch	g	TL/Ad.
3020 12 2160	160	6 1/4"	205	224,75
3020 12 2180	180	7 1/8"	275	255,00
3020 12 2200	200	8"	315	287,75

**3020****Kombine Pense Kraft Seri**  
*Combination Pliers*TS 60  
TS ISO 5746  
DIN ISO 5746Özel alaşımli çelik, Kesici ağızlar indüksiyonda sertleştirilmiş  
*Special steel, Cutters induction hardened*

KOD CODE	L mm	L inch	g	TL/Ad.
3020 12 3160	160	6 1/4"	225	275,25
3020 12 3180	180	7 1/8"	285	307,50
3020 12 3200	200	8"	380	347,50

**3020****1000V İzoleli Elektrikçi Kombine Pense**  
*Electrician Type Insulated*  
*Combination Pliers 1000V*TS 60  
TS ISO 5746  
DIN ISO 5746⚡ 1000 V  
IEC 60900Özel alaşımli çelik, Kesici ağızlar indüksiyonda sertleştirilmiş, Krom kaplı  
*Special steel, Cutters induction hardened, Chrom plated*

KOD CODE	L mm	L inch	g	TL/Ad.
3020 12 6160	160	6 1/4"	205	309,25
3020 12 6180	180	7 1/8"	260	331,25
3020 12 6200	200	8"	345	373,75

**3030****Kombine Pense Ağır Tip (çelik tel için)**  
*Combination Pliers Heavy Duty*  
*(for piano wire)*Özel alaşımli çelik, Kesici ağızlar indüksiyonda sertleştirilmiş,  
*Special steel, Cutters induction hardened*

KOD CODE	L mm	L inch	g	TL/Ad.
3030 12 2180	180	7 1/8"	285	384,00
3030 12 2200	200	8"	380	439,25



**Kargaburun Düz Uçlu Opak Seri**  
*Long Nose Pliers (Flat)*



TS 60 - TS ISO 5745  
DIN ISO 5745



İZELTAS YOUTUBE

Özel alaşımli çelik, Kesici ağızlar indüksiyonda sertleştirilmiş  
*Special steel, Cutters induction hardened*

KOD CODE	L mm	L inch	g	TL/Ad.
3220 13 2140	140	5 1/2"	110	221,25
3220 13 2160	160	6 1/4"	135	250,25
3220 13 2180	180	7 1/8"	170	275,00
3220 13 2200	200	8"	205	291,50

**Kargaburun Düz Uçlu Kraft Seri**  
*Long Nose Pliers (Flat)*

TS 60 - TS ISO 5745  
DIN ISO 5745



Özel alaşımli çelik, Kesici ağızlar indüksiyonda sertleştirilmiş  
*Special steel, Cutters induction hardened*

KOD CODE	L mm	L inch	g	TL/Ad.
3220 13 3140	140	5 1/2"	120	273,25
3220 13 3160	160	6 1/4"	155	308,25
3220 13 3180	180	7 1/8"	185	339,25
3220 13 3200	200	8"	210	359,50

**1000V İzoleli Elektrikçi Kargaburun Düz Uçlu**  
*Insulated Electrician Type*  
*Long Nose Pliers 1000V*



TS 60  
TS ISO 5745  
DIN ISO 5745  
△ 1000  
IEC 60900



Özel alaşımli çelik, Kesici ağızlar indüksiyonda sertleştirilmiş, Krom kaplı  
*Special steel, Cutters induction hardened, Chrom plated*

KOD CODE	L mm	L inch	g	TL/Ad.
3220 13 6140	140	5 1/2"	110	316,50
3220 13 6160	160	6 1/4"	140	350,00
3220 13 6180	180	7 1/8"	160	392,75
3220 13 6200	200	8"	170	408,00

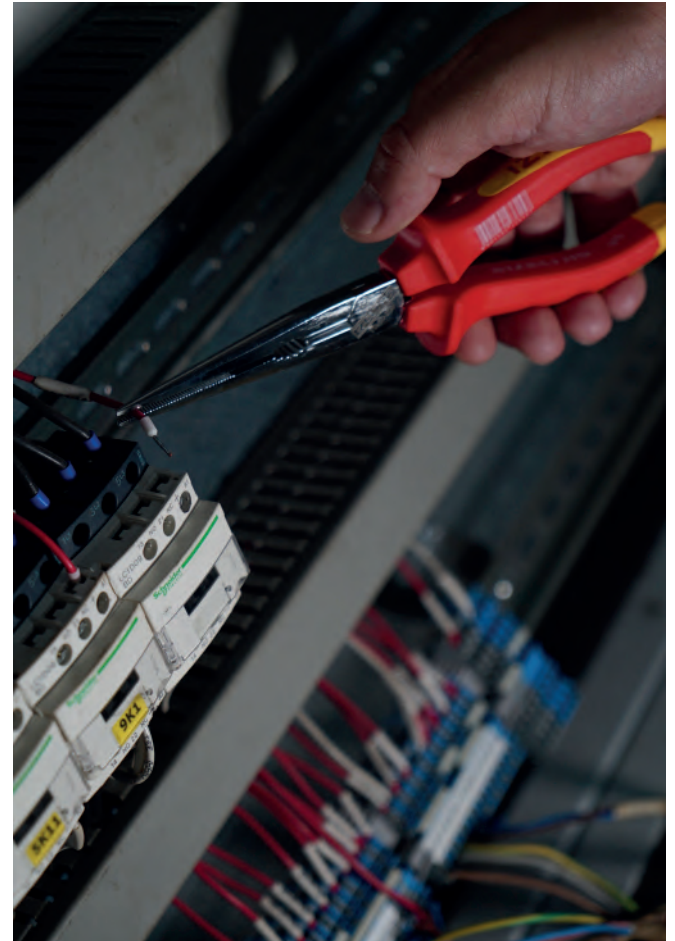

**3225**
**Kargaburun Eğri Uçlu Opak Seri**  
*Long Nose Pliers (Bent)*
  
 TS 60 - TS ISO 5745

Özel alaşımli çelik, Kesici ağızlar induksiyonda sertleştirilmiş  
*Special steel, Cutters induction hardened*

KOD CODE	L mm	L inch	g	TL/Ad.
3225 13 2160	160	6 1/4"	140	264,25
3225 13 2180	180	7 1/8"	170	298,75
3225 13 2200	200	8"	175	319,00

**3225**
**Kargaburun Eğri Uçlu Kraft Seri**  
*Long Nose Pliers (Bent)*
  
 TS 60 - TS ISO 5745

Özel alaşımli çelik, Kesici ağızlar induksiyonda sertleştirilmiş  
*Special steel, Cutters induction hardened*

KOD CODE	L mm	L inch	g	TL/Ad.
3225 13 3160	160	6 1/4"	150	317,75
3225 13 3180	180	7 1/8"	190	349,00
3225 13 3200	200	8"	195	383,75

**3020 00 2003**
**Opak Pense Seti 160mm ( 3 Parça )**  
*Opak Pliers Set 160mm ( 3 Pcs )*

KOD CODE	L mm	İÇERİK CONTENTS	TL Ad.
3020 12 2160	160	<b>Kombine Pense Opak Seri</b> Combination Pliers 160mm	1
3220 13 2160	160	<b>Kargaburun Düz Uçlu Opak Seri</b> Long Nose Pliers (Flat) 160mm	1
3700 16 2160	160	<b>Yan Keski Opak Seri</b> Side Cutting Pliers 160mm	1

**3020 00 1002**
**Pense Kontrol Kalemi Set (2 Parça)**  
*Opak Pliers Set, Voltage Tester (Flat) 2 Pcs*

**ANAHTARLIK HEDİYELİ**



KOD CODE	L mm	İÇERİK CONTENTS	TL Ad.
3020 12 2160	160	<b>Kombine Pense Opak Seri</b> Combination Pliers 160mm	1
4550 17 0190	190	<b>Elektrik Kontrol Kalemi (Düz Uçlu)</b> Voltage Tester (Flat) 190mm	1

**Yan Keski Opak Seri**  
*Side Cutting Pliers*TS 60 - TS ISO 5749  
DIN ISO 5749

İZELTAŞ YOUTUBE

Özel alaşımli çelik, Kesici ağızlar indüksiyonda sertleştirilmiş  
*Special steel, Cutters induction hardened*

KOD CODE	L mm	L inch	g	□	TL/Ad.
3700 16 2140	140	5 1/2"	165	5	233,75
3700 16 2160	160	6 1/4"	230	5	281,50
3700 16 2180	180	7 1/8"	230	5	328,25

**Yan Keski Kraft Seri**  
*Side Cutting Pliers*TS 60 - TS ISO 5749  
DIN ISO 5749

Özel alaşımli çelik, Kesici ağızlar indüksiyonda sertleştirilmiş  
*Special steel, Cutters induction hardened*

KOD CODE	L mm	L inch	g	□	TL/Ad.
3700 16 3140	140	5 1/2"	190	5	282,00
3700 16 3160	160	6 1/4"	240	5	338,75
3700 16 3180	180	7 1/8"	255	5	394,50

**1000V İzoleli Elektrikçi Yan Keski**  
*Insulated Electrician Type Side Cutter 1000V*TS 60  
TS ISO 5749  
DIN ISO 5749  
⚡ 1000 V  
IEC 60900

Özel alaşımli çelik, Kesici ağızlar indüksiyonda sertleştirilmiş, Krom kaplı  
*Special steel, Cutters induction hardened, Chrom plated*

KOD CODE	L mm	L inch	g	□	TL/Ad.
3700 16 6140	140	5 1/2"	165	5	354,75
3700 16 6160	160	6 1/4"	215	5	402,75
3700 16 6180	180	7 1/8"	225	5	450,50

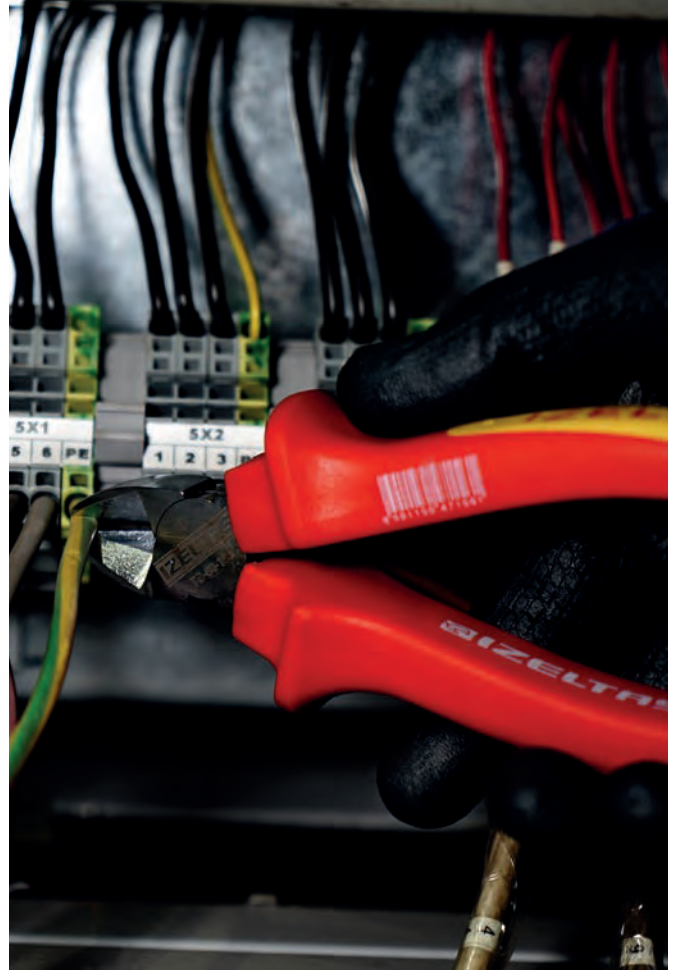

**YAN KESKİ KRAFT SERİ / SIDE CUTTING PLIERS**

Nikel üzerine krom kaplama ile  
korozyon direncinde  
üst seviye koruma  
High corrosion resistance with chrome over nickel  
plating

Isıl işlem sonrası ilave indüksiyonla sertleştirme ile  
kullanım ömrü arttırılmış kesici ağızlar  
Heat-treated and induction hardened cutting edges for long lifetime

Yüksek karbonlu sıcak dövme çeliği ile  
arttırılmış dayanım  
High carbon forged steel for  
improved durability

TSE  
standartlarına  
uygun üretim  
Prodion acc. to  
TSE standards

Düşmelere ve darbeye  
dayanıklı, selüloz  
asetat ergonomik sap  
Impact resistant cellulose  
acetate handle



İZELTAS YOUTUBE

**3705**

İnce Uçlu Yan Keski (Plastikler İçin)  
Side Cutter For Plastics

TS 60  
TS ISO 5749

**3730**

Yan Keski Ağır Tip (Çelik Tel İçin)  
Side Cutter Heavy Duty (for piano wire)



Özel alaşımli çelik, Kesici ağızlar induksiyonda sertleştirilmiş, PVC izoleli  
Special steel, Cutters induction hardened, PVC insulated

Özel alaşımli çelik, Kesici ağızlar induksiyonda sertleştirilmiş  
Special steel, Cutters induction hardened

KOD CODE	L mm	L inch	g	TL/Ad.
3705 16 5160	160	6 1/4"	220	5 366,25

KOD CODE	L mm	L inch	g	TL/Ad.
3730 16 2160	160	6 1/4"	200	5 399,25
3730 16 2200	200	8"	320	5 518,75

**3335 00 1004**

Segman Pense Takımı (4 Parça)  
Circlip Pliers Set (4 Pcs)



330112 0180  
Dış Segman Pense (Düz) ● 19-60



3311 12 0170  
Dış Segman Pense (Eğri) ● 19-60



3321 12 0180  
İç Segman Pense (Düz) ● 19-60



3331 12 0170  
İç Segman Pense (Eğri) ● 19-60



İZELTAS YOUTUBE

KOD CODE	L mm	İÇERİK CONTENTS	TL Ad.
3301 12 0180	180	<b>Dış Segman Pense (Düz)</b> Circlip Pliers, External (Flat)	1
3311 12 0170	170	<b>Dış Segman Pense (Eğri)</b> Circlip Pliers, External (Bent)	1
3321 12 0180	180	<b>İç Segman Pense (Düz)</b> Circlip Pliers, Internal (Flat)	1
3331 12 0170	170	<b>İç Segman Pense (Eğri)</b> Circlip Pliers, Internal (Bent)	1



### 3301

#### Dış Segman Pense (Düz) Circlip Pliers, External (Flat)



TS 60  
DIN 5254



Krom vanadyum, Krom kaplı, PVC izoleli  
Chrom vanadium, Chrom plated, PVC insulated

KOD CODE	L mm	⌀	g	□	TL/Ad.
3301 12 0140	140	10 - 25	90	5	264,00
3301 12 0180	180	19 - 60	195	5	278,50
3301 12 0225	225	40 - 100	235	5	348,00
3301 12 0295	295	85 - 140	445	5	590,00

### 3321

#### İç Segman Pense (Düz) Circlip Pliers Internal (Flat)



TS 60  
DIN 5256



Krom vanadyum, Krom kaplı, PVC izoleli  
Chrom vanadium, Chrom plated, PVC insulated

KOD CODE	L mm	⌀	g	□	TL/Ad.
3321 12 0140	140	12 - 25	100	5	243,25
3321 12 0180	180	19 - 60	185	5	256,50
3321 12 0225	225	40 - 100	250	5	319,25
3321 12 0310	310	85 - 140	445	5	548,00

### 3311

#### Dış Segman Pense (Eğri) Circlip Pliers, External (Bent)



TS 60  
DIN 5254



Krom vanadyum, Krom kaplı, PVC izoleli  
Chrom vanadium, Chrom plated, PVC insulated

KOD CODE	L mm	⌀	g	□	TL/Ad.
3311 12 0125	125	10 - 25	105	5	295,25
3311 12 0170	170	19 - 60	190	5	310,75
3311 12 0210	210	40 - 100	250	5	357,25
3311 12 0275	275	85 - 140	445	5	619,50

### 3331

#### İç Segman Pense (Eğri) Circlip Pliers Internal (Bent)



TS 60  
DIN 5256



Krom vanadyum, Krom kaplı, PVC izoleli  
Chrom vanadium, Chrom plated, PVC insulated

KOD CODE	L mm	⌀	g	□	TL/Ad.
3331 12 0130	130	12 - 25	105	5	261,50
3331 12 0170	170	19 - 60	185	5	275,25
3331 12 0210	210	40 - 100	250	5	343,50
3331 12 0290	290	85 - 140	440	5	589,50

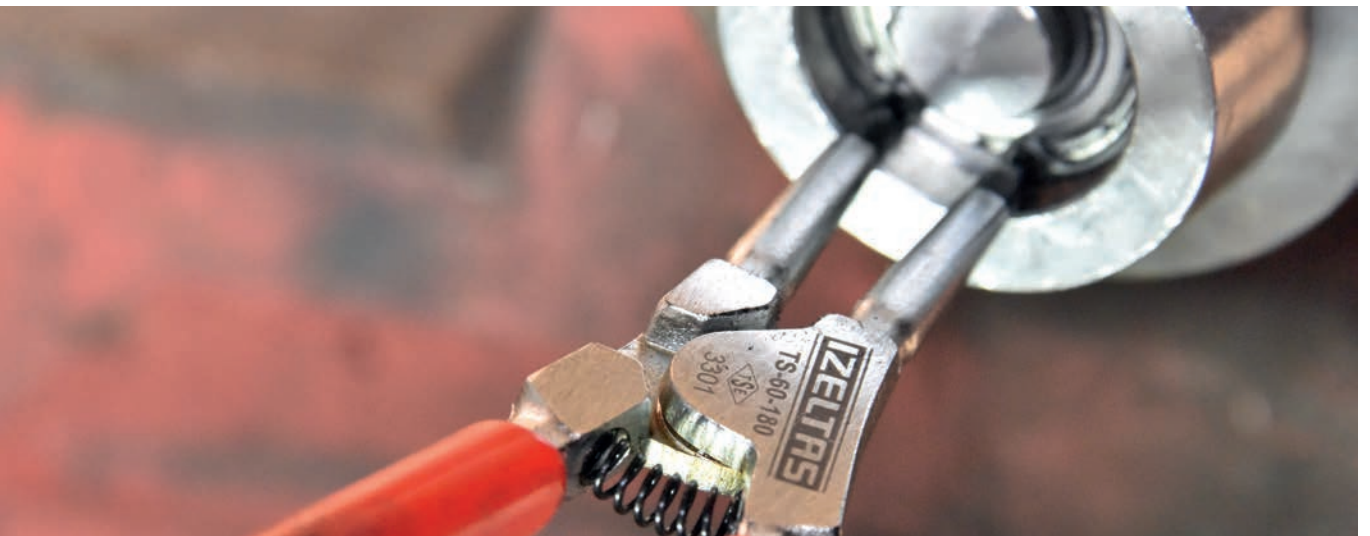

**3420****Hortum Keleçe Pensesi**  
*Hose Clamp Pliers*

KOD CODE	L mm	L inch	g	TL/Ad.
3420 12 0220	220	8 3/4"	185	5 469,50

**3425****Hortum Keleçe Pensesi (Sıkıştırma Tipi)**  
*Hose Clamp Pliers*

KOD CODE	L mm	L inch	g	TL/Ad.
3425 12 0220	235	9 1/4"	355	5 481,00

**3852****Delik Zımba**  
*Revolving Punch Pliers*Ölçü / Size  $\emptyset 2 - \emptyset 2.5 - \emptyset 3 - \emptyset 3.5 - \emptyset 4 - \emptyset 4.5$ 

KOD CODE	L mm	L inch	g	TL/Ad.
3852 24 0225	225	9"	270	5 328,50



**3715**

**Tek Ağızlı Kablo Kesici**  
*Cable Cutter*



Özel alaşımlı çelik, Kesici ağızlar indüksiyonda sertleştirilmiş, PVC izoleli  
*Special steel, Cutters induction hardened, PVC insulated*

KOD CODE	L mm	L inch	g	TL/Ad.
3715 16 0165	165	6 1/4	210	301,75

**3715**

**1000V İzoleli Tek Ağızlı Kablo Kesici**  
*Cable Cutter 1000V*

⚡ 1000 V  
IEC 60900



Özel alaşımlı çelik, Kesici ağızlar indüksiyonda sertleştirilmiş  
*Special steel, Cutters induction hardened*

KOD CODE	L mm	L inch	g	TL/Ad.
3715 16 6165	165	6 1/4	230	355,75

**Çift Ağızlı Kablo Kesici**  
*Cable Cutter, Double Cutter*

Özel alaşımli çelik, Kesici ağızlar indüksiyonda sertleştirilmiş, PVC izoleli  
*Special steel, Cutters induction hardened, PVC insulated*

KOD CODE	L mm	L inch	g	TL/Ad.
3720 16 0220	220	9"	320	5 404,50

**Testere Çaprazı**  
*Saw - Setting Pliers*

TSEK



Özel alaşımli çelik, İndüksiyonda sertleştirilmiş,  
Natural Vernikli, PVC izoleli  
*Special steel, induction hardened, PVC insulated*

KOD CODE	L mm	L inch	g	TL/Ad.
3860 26 0180	180	7 1/8"	245	5 373,25



**3550**

**Elektronikçi Yan Keski**  
*Electronic Diagonal Side Cutting Pliers*



Özel alaşımli çelik  
*Special steel*

KOD CODE	L mm	g		TL/Ad.
3550 14 0125	125	76	5	320,50

**3553**

**Elektronikçi Düz Uçlu Kargaburun**  
*Electronic Flat Nose Pliers*



Özel alaşımli çelik  
*Special steel*

KOD CODE	L mm	g		TL/Ad.
3553 14 0150	150	88	5	289,25

**3551**

**Elektronikçi Tepe Keski**  
*Electronic End Cutting Pliers*



Özel alaşımli çelik  
*Special steel*

KOD CODE	L mm	g		TL/Ad.
3551 14 0125	125	77	5	299,25

**3554**

**Elektronikçi Uzun Kargaburun**  
*Electronic Long Nose Pliers*



Özel alaşımli çelik  
*Special steel*

KOD CODE	L mm	g		TL/Ad.
3554 14 0150	150	88	5	289,25

**3552**

**Elektronikçi Yuvarlak Uçlu Kargaburun**  
*Electronic Round Nose Pliers*



Özel alaşımli çelik  
*Special steel*

KOD CODE	L mm	g		TL/Ad.
3552 14 0125	125	78	5	290,25

**3555**

**Elektronikçi Sivri Uçlu Düz Kargaburun**  
*Electronic Needle Flat Nose Pliers*



Özel alaşımli çelik  
*Special steel*

KOD CODE	L mm	g		TL/Ad.
3555 14 0150	150	86	5	289,25

**3556**

**Elektronikçi Sivri Uçlu Eğri Kargaburun**  
*Electronic Needle Bent Nose Pliers*



Özel alaşımli çelik  
*Special steel*

KOD CODE	L mm	g	TL/Ad.
3556 14 0150	150	85	289,25

**3557**

**Elektronikçi Pense**  
*Electronic Pliers*



Özel alaşımli çelik  
*Special steel*

KOD CODE	L mm	g	TL/Ad.
3557 14 0125	125	80	290,25

**3560 00 2104**

**Elektronikçi Keski ve Pense Seti (4 Parça)**  
*Electronic Cutter & Pliers Set (4 Pcs)*

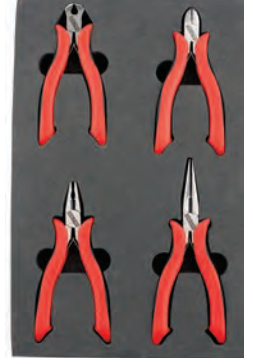

KOD CODE	L mm	İÇERİK CONTENTS	TL Ad.
3550 14 0125	125	<b>Elektronikçi Yan Keski</b> Electronic Diagonal Side Cutting Pliers	1
3551 14 0125	125	<b>Elektronikçi Tepe Keski</b> Electronic End Cutting Pliers	1
3554 14 0150	150	<b>Elektronikçi Uzun kargaburun</b> Electronic Long Nose Pliers	1
3557 14 0125	125	<b>Elektronikçi Pense</b> Electronic Pliers	1
			1.199,25

**3565 00 2104**

**Elektronikçi Kargaburun Seti (4 Parça)**  
*Electronic Long Nose Pliers Set (4 Pcs)*

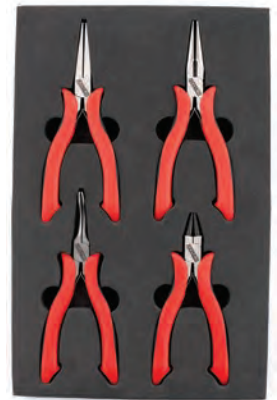

KOD CODE	L mm	İÇERİK CONTENTS	TL Ad.
3552 14 0125	125	<b>Elektronikçi Yuvarlak Uçlu Kargaburun</b> Electronic Round Nose Pliers	1
3553 14 0150	150	<b>Elektronikçi Düz Uçlu Kargaburun</b> Electronic Flat Nose Pliers	1
3555 14 0150	150	<b>Elektronikçi Sivri Uçlu Düz Kargaburun</b> Electronic Needle Nose Pliers	1
3556 14 0150	150	<b>Elektronikçi Sivri Uçlu Eğri Kargaburun</b> Electronic Bent Needle Nose Pliers	1
			1.158,00

### 3800

**Kerpeten**  
*Carpenter Pincers*

TS 60 - TS ISO 9243  
DIN ISO 9243



Özel alaşımlı çelik, Kesici ağızlar indüksiyonda sertleştirilmiş,  
Mangan Fosfat Kaplı, PVC izoleli

*Special steel, Cutters induction hardened, Black finish, PVC insulated*

KOD CODE	L mm	L inch	g		TL/Ad.
3800 15 0160	160	6 1/4"	220	5	231,25
3800 15 0180	180	7 1/8"	295	5	239,25
3800 15 0200	200	8"	330	5	319,00
3800 15 0250	250	10"	530	5	347,50

### 3830

**Betoncu Kerpeteni**  
*Tower Pincers*

TS 60 • TS ISO 9242  
DIN ISO 9242



Özel alaşımlı çelik, Kesici ağızlar indüksiyonda sertleştirilmiş,  
Mangan Fosfat Kaplı, PVC izoleli

*Special steel, Cutters induction hardened, Black finish, PVC insulated*

KOD CODE	L mm	L inch	g		TL/Ad.
3830 15 0225	225	9"	345	5	287,00
3830 15 0250	250	10"	395	5	317,00
3830 15 0280	280	11"	450	5	378,50

### 3831

**Betoncu Kerpeteni Yaylı**  
*Tower Pincers with spring*

TS 60 - TS ISO 9242  
DIN ISO 9242



Özel alaşımlı çelik, Kesici ağızlar indüksiyonda sertleştirilmiş,  
Mangan Fosfat Kaplı, PVC izoleli

*Special steel, Cutters induction hardened, Black finish, PVC insulated*

KOD CODE	L mm	L inch	g		TL/Ad.
3831 15 0280	280	11"	455	5	379,75

### 3835

**Ağır Tip Betoncu Kerpeteni**  
*Heavy Tower Pincers*

TS 60 - TS ISO 9242  
DIN ISO 9242



İZELTAS YOUTUBE

Özel alaşımlı çelik, Kesici ağızlar indüksiyonda sertleştirilmiş,  
Mangan Fosfat Kaplı, PVC izoleli

*Special steel, Cutters induction hardened, Black finish, PVC insulated*

KOD CODE	L mm	L inch	g		TL/Ad.
3835 15 0280	280	11"	400	5	376,50

### 3850

**Danalya**  
*Shoemaker Pliers*



Özel alaşımlı çelik, İndüksiyonda sertleştirilmiş, Siyah Oksit kaplı

*Special steel, Induction hardened, Black finish*

KOD CODE	L mm	L inch	g		TL/Ad.
3850 12 0200	200	8"	360	5	467,50





# 1000V İZOLELİ ALETLER

1000V INSULATED TOOLS



İZELTAŞ YOUTUBE

1000V PRODUCT GROUP

1000V ERİŞİMLİ  
ALETLER

## VDE BELGELİ ÜRÜNLERİMİZ / VDE CERTIFIED PRODUCTS



- » El aletleri sektörünün lider markası İZELTAŞ'ın VDE belgeli ürünleri elektrik sektöründe fark yaratıyor.
- Bu ürünler elektrik sektöründe 1000V izolasyon sağlamak için özel olarak tasarlanmış yanmaz sapları ile kullanıcıya güven verir.
  - Elektrik akımının bulunduğu alanlarda güvenli kullanım sağlar.
  - Yanma, 1000V elektrik direnci, soğuk ve sıcak havalarda sap sökme deneyleri başta olmak üzere pek çok özel testten geçirilen ürünler, Alman VDE firmasından onaylıdır.
  - Ergonomik sap tasarımı ile tutuş ve kullanım kolaylığı sağlar.

- » As the leading brand in hand tools sector, CDE certified products of İZELTAŞ make a difference in electrical sector.
- These products assure the user with their handles specially designed to provide isolation up to 1000 V.
  - They provide safe use in areas with electrical current.
  - The products are certified by German VDE institution, being subjected to various tests particularly including fire resistance, 1000 V electrical resistance and handle detachment tests in hot and cold air conditions.
  - They provide ease of grip and use with an ergonomic design.



### Çalışma sırasında nelere dikkat edilmelidir?

- Elektrik akımının var olduğu alanlarda yalnızca özel eğitilmiş ve alanında uzman kişiler çalışmalıdır.
- Her kullanım öncesinde VDE belgeli ürünlerde ve izolelerinde hasar olup olmadığı kontrol edilmelidir.
- VDE belgeli ürünler amacı dışında ya da birleştirilerek kullanılmamalıdır.
- VDE belgeli ürünler ile koruyucu ekipmanlarımızı da güvenlik amacıyla kullanmalısınız.

### Important points for use

- Only specially trained and expert personnel should engage in work in areas with electrical current.
- Before each use VDE certified products and their isolation materials should be checked against damage.
- VDE certified products should not be used outside their purpose or in combination.
- Protective equipment should also be used to protect personnel in addition to VDE certified products.

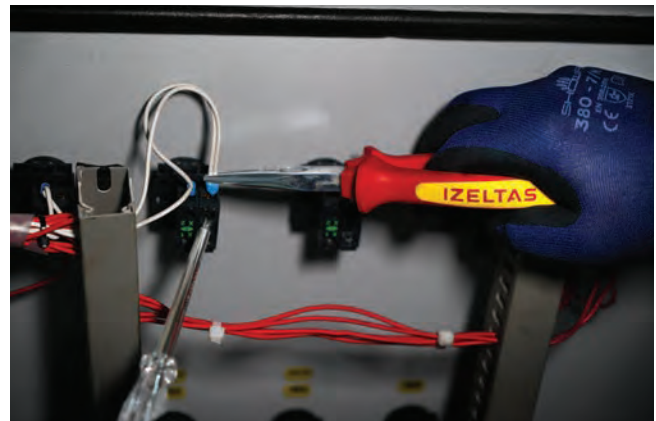

## VDE belgeli ürünlerimiz, ilgili uluslararası standartlara göre kontrol edildikten sonra ek olarak beş ayrı teste tabi tutulur

- » 1- Voltaj Testi: 3 dakika boyunca 10.000V'a tabi tutulan izoleli el aletinde kaçak yada elektrik akımı atlaması olmamalıdır.
- 2- Soğuk Şoklama Testi : -24 derece 2 saat bekletilmiş (şoklanmış) el aletine 60-80 cm yükseklikten 600gr ağırlık ile darbeler uygulanır. İzolede kırılma ya da çatlama olmamalıdır.
- 3- Dayanıklılık Testi: +70 derece 1 hafta bekletilmiş el aletine 50kg yük ile sap sökme testi uygulanır. Sap yerinden çıkmamalıdır.
- 4- Geçirgenlik Testi: 5000V elektrik akımına karşı 3 dakika boyunca 2kg sivri uçlu ağırlıkta baskı yapılarak elektrik verilir. Kaçak ya da elektrik atlaması olmamalıdır.
- 5- Yanma Testi: Yüksek yoğunluktaki alev 20 saniye maruz bırakılarak teste tabi tutulur. Alevden uzaklaştırılan izole yanmaya devam etmemelidir.

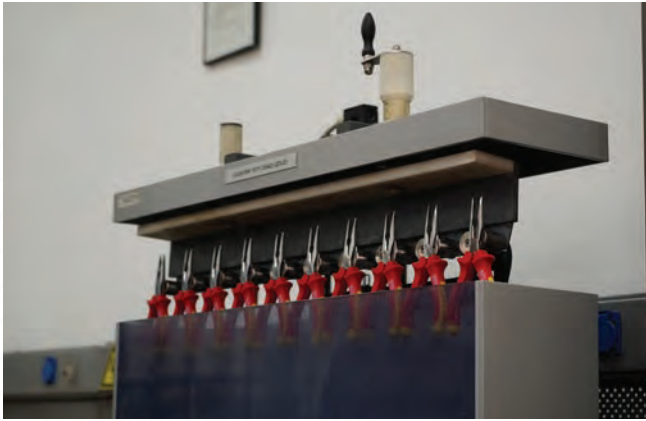

## Our VDE certified products are controlled in accord with the applicable international standards and then are subjected to five different tests:

- » 1- Voltage Test: No residual current or electrical arc should be seen on the isolated hand tool subjected to 10,000 V for 3 minutes.
- 2- Cold Shock Test: Hand tools left in -24 °C for 2 hours (shocked) are subjected to impacts with a 600 gr weight dropped from a height of 60-80 cm. No breakage or cracking should be seen on the isolation material.
- 3- Durability Test: Hand tools left in +70 °C for 1 week are subjected to handle detachment test with a load of 50 kg. The handle should not detach.
- 4- Perviousness Test: Pointed tips under 2 kg load are used to apply 5000 V electrical current for 3 minutes. There should be no residual current or electrical arc.
- 5- Fire Test: The tool is subjected to high intensity flames for 20 seconds. After contact with the flame is ended the isolation material should not continue burning.



Güçlü kavrama sağlayan  
tırnaklı tutma yüzeyleri  
Toothed surface for strong grip

Isıl işlem sonrasında indüksiyonda  
sertleştirme ile kullanım  
ömürü artırılmış kesici ağızlar  
Heat-treated and induction hardened cutting edges for long  
lifetime

Nikel üzerine krom kaplama ile  
korozyon direncinde  
üst seviye koruma  
High corrosion resistance  
with chrome over nickel plating

Yüksek karbonlu  
sıcak dövme çeliği  
ile arttırılmış  
dayanım  
High carbon forged steel for  
improved durability

VDE/GS belgeli, 1000V dayanımlı,  
sert plastikten ve konforlu tutuş  
sağlayan yumuşak elastomer  
malzemeden imal edilmiş  
dayanımı yüksek çift  
komponentli ergonomik sap  
VDE/GS certified, insulated for 1000V  
usage. Two component ergonomic  
handle with high strength and  
soft grip plastic



İZELTAS YOUTUBE

## 0255

**Süper İzole Çatal Bir Ağız Anahtar (mm)**  
*Single Ended Open Jaw Wrench*  
*Super Insulated (mm)*

IEC 60900  
 ⚡ 1000 V



**Krom vanadyum, Krom kaplı, Kalın PVC izoleli**  
*Chrom vanadium, Chrom plated, Triple PVC insulated*

KOD CODE	mm	L mm	g	TL/Ad.
0255 01 0010	10	110	40	107,50
0255 01 0011	11	120	45	113,50
0255 01 0012	12	130	50	118,75
0255 01 0013	13	140	60	127,75
0255 01 0014	14	155	75	132,50
0255 01 0017	17	170	100	162,50
0255 01 0019	19	185	150	190,75
0255 01 0022	22	200	200	256,50
0255 01 0024	24	220	280	314,00

## 0435

**Süper İzoleli Yıldız Bir Ağız Anahtar (mm)**  
*Single Ended Ring Wrench*  
*Super Insulated (mm)*

IEC 60900  
 ⚡ 1000 V



**Krom vanadyum, Krom kaplı, Kalın PVC izoleli**  
*Chrom vanadium, Chrom plated, Triple PVC insulated*

KOD CODE	mm	L mm	g	TL/Ad.
0435 03 0010	10	170	100	143,25
0435 03 0011	11	175	110	143,25
0435 03 0012	12	180	130	162,50
0435 03 0013	13	185	150	162,50
0435 03 0014	14	190	180	170,75
0435 03 0017	17	205	220	193,25
0435 03 0019	19	220	270	230,75
0435 03 0022	22	245	310	252,75
0435 03 0024	24	270	420	337,75

**1000V 1/2" Altı Köşe Lokma Anahtar (mm)**  
*Socket Wrench 6 Points 1000V (mm)*

TS ISO 2725-1  
 DIN 3124

⚡ 1000 V  
 IEC 60900



**Krom vanadyum, Krom kaplı**  
*Chrom vanadium, Chrom plated*

KOD CODE	mm	ø D1 mm	ø D2 mm	L mm	L1 mm	g	TL/Ad.
13000 005148	10	19,5	27	40	7	55	1 226,00
13000 005149	11	20,7	27	40	7	55	1 224,75
13000 005150	12	22	27	40	8	55	1 228,75
13000 005151	13	23,2	27	40	8	60	1 229,75
13000 005152	14	24,5	27	40	9	60	1 231,50
13000 005153	15	25,7	27	40	10	65	1 232,75
13000 005154	16	27	27	40	11	65	1 237,25
13000 005155	17	28,2	27	40	11	65	1 240,25
13000 005156	19	30,7	27	42	11	70	1 245,50
13000 005157	22	34,5	27	44	12	70	1 251,50
13000 005158	24	37	27	46	13	75	1 256,75
13000 005159	27	40,7	27	48	13	75	1 302,75

## 13000 005277

**1000V 1/2" Cırcır Kolu**  
*Ratchet Handle 1000V*

IEC 60900  
 ⚡ 1000 V



**Krom vanadyum, Krom kaplı**  
*Chrom vanadium, Chrom plated*

KOD CODE	L mm	g	TL/Ad.
13000 005277	275	540	1 2.184,25

**1000V Ara Kol**  
*Extension Bar 1000V*



TS ISO 3316  
DIN 3123  
⚡ 1000 V  
IEC 60900



**Krom vanadyum, Krom kaplı**  
*Chrom vanadium, Chrom plated*

KOD CODE	L mm	g	TL/Ad.
13000 005262	75	140	1 578,75
13000 005263	125	215	1 641,50
13000 005264	250	420	1 871,50

**2400**

**1000V İzoleli Üniversal Fort Pense**  
*Insulated Type Waterpump*  
*Pliers Universal 1000V*



TS 60  
TS ISO 8976  
IEC 60900  
⚡ 1000 V



**Krom vanadyum, Krom kaplı, çift komponent saplı**  
*Chrom vanadium, Chrom plated, Two component handle*

KOD CODE	L mm	L inch	mm	g	TL/Ad.
2400 11 6240	240	9 1/2"	35	370	5 419,25

**3020**

**1000V İzoleli Elektrikçi Kombine Pense**  
*Insulated Electrician Type*  
*Combination Pliers 1000V*



TS 60  
TS ISO 5746  
DIN ISO 5746

⚡ 1000 V  
IEC 60900



**Özel alaşımli çelik, Kesici ağızlar indüksiyonda sertleştirilmiş, Krom kaplı**  
*Special steel, Cutters induction hardened, Chrom plated*

KOD CODE	L mm	L inch	g	TL/Ad.
3020 12 6160	160	6 1/4"	205	5 309,25
3020 12 6180	180	7 1/8"	260	5 331,25
3020 12 6200	200	8"	345	5 373,75



## 3220

### 1000V İzoleli Elektrikçi Kargaburun Düz Uçlu Insulated Electrician Type Nose Pliers 1000V

  
TS 60  
TS ISO 5745  
DIN ISO 5745  
⚡ 1000 V  
IEC 60900



Özel alaşımli çelik, Kesici ağızlar indüksiyonda sertleştirilmiş, Krom kaplı  
Special steel, Cutters induction hardened, Chrom plated

KOD CODE	L mm	L inch	g	□	TL/Ad.
3220 13 6140	140	5 1/2"	110	5	316,50
3220 13 6160	160	6 1/4"	140	5	350,00
3220 13 6180	180	7 1/8"	160	5	392,75
3220 13 6200	200	8"	170	5	408,00

## 3700

### 1000V İzoleli Elektrikçi Yan Keski Insulated Electrician Type Side Cutter 1000V

  
TS 60  
TS ISO 5749  
DIN ISO 5749  
⚡ 1000 V  
IEC 60900



Özel alaşımli çelik, Kesici ağızlar indüksiyonda sertleştirilmiş, Krom kaplı  
Special steel, Cutters induction hardened, Chrom plated

KOD CODE	L mm	L inch	g	□	TL/Ad.
3700 16 6140	140	5 1/2"	165	5	354,75
3700 16 6160	160	6 1/4"	215	5	402,75
3700 16 6180	180	7 1/8"	225	5	450,50

## 3715

### 1000V İzoleli Tek Ağızlı Kablo Kesici Cable Cutter 1000V

⚡ 1000 V  
IEC 60900



Özel alaşımli çelik, Kesici ağızlar indüksiyonda sertleştirilmiş  
Special steel, Cutters induction hardened

KOD CODE	L mm	L inch	g	□	TL/Ad.
3715 16 6165	165	6 1/4"	150	5	355,75

## 3020 00 6003

### 1000V İzoleli Elektrikçi Seti (3 Parça) 1000V Insulated Tool Set (3 Pcs)



KOD CODE	İÇERİK CONTENTS	□	TL/Ad.
3020 12 6160	<b>160 mm 1000V İzoleli Elektrikçi Kombine Pense</b> Insulated Electrician Type Combination Pliers	1	
3220 13 6160	<b>160 mm 1000V İzoleli Elektrikçi Kargaburun Düz Uçlu</b> Insulated Electrician Type Nose Pliers	1	1.062,00
3700 16 6160	<b>160 mm 1000V İzoleli Elektrikçi Yankeski</b> Insulated Electrician Type Side Cutter	1	

**4140**

**1000V İzoleli Elektrikçi Düz Uçlu Tornavida**  
*Insulated Electrician Type Flat*  
*Screwdriver 1000V*

TS 59  
 TS ISO 2380-1  
 DIN ISO 2380-1  
 ⚡ 1000 V  
 IEC 60900

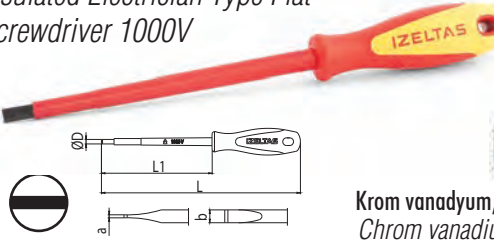

**Krom vanadyum, Siyah oksit kaplı**  
*Chrom vanadium, Black finish*

KOD CODE	øDxL1 mm	⊖		L mm	g	□	TL/Ad.
		a mm	b mm				
4140 17 2575	2.5x75	0.4	2.5	150	25	10	50,75
4140 17 4100	4x100	0.8	4	185	40	10	59,50
4140 17 5512	5.5x125	1	5.5	220	70	10	78,50
4140 17 6515	6.5x150	1.2	6.5	245	90	10	87,75

**4145**

**1000V İzoleli Elektrikçi Yıldız Uçlu Tornavida**  
*Insulated Electrician Type Phillips*  
*Screwdriver 1000V*

TS 59  
 TS 59-5 ISO 8764  
 DIN ISO 8764  
 ⚡ 1000 V  
 IEC 60900

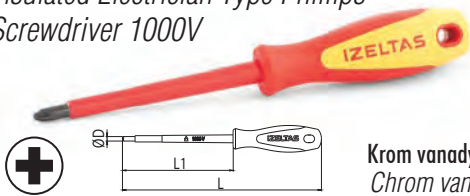

**Krom vanadyum, Siyah oksit kaplı**  
*Chrom vanadium, Black finish*

KOD CODE	øDxL1 mm	⊕	L mm	g	□	TL/Ad.
4145 18 0360	3x60	Ph0	135	25	10	52,75
4145 18 4580	4.5x80	Ph1	165	45	10	74,50
4145 18 6100	6x100	Ph2	195	70	10	87,75

**4140**

**1000V İzoleli Elektrikçi Tornavida Seti (6 Parça)**  
*Insulated Electrician Set (6 Pcs) Screwdriver 1000V*



KOD CODE	İÇERİK CONTENTS	g	□	TL/Ad.
4140 00 9106	2.5x75 - 4x100	340	6	438,75
	⊖ 5.5x125 - 6.5x150			
	Düz uçlu / Flat			
	⊕ 4.5x80 - 6x100			
	Yıldız uçlu / Phillips			

**4773**

**1000V Süngüsü İzoleli Lokma Uçlu Tornavida**  
*Nut Spinner, Electrician Blade Insulated 1000V*

DIN 3125



**Krom vanadyum, iki komponent saplı**  
*Chrome vanadium, Two component handle*

KOD CODE	⊖ mm	L mm	L1 mm	g	□	TL/Ad.
4773 19 0040	4	220	125	90	10	165,00
4773 19 0050	5	220	125	90	10	165,00
4773 19 0055	5.5	220	125	90	10	165,00
4773 19 0060	6	220	125	90	10	165,00
4773 19 0070	7	230	125	110	10	176,75
4773 19 0080	8	230	125	120	10	176,75
4773 19 0090	9	230	125	125	10	191,00
4773 19 0100	10	230	125	125	10	191,00
4773 19 0110	11	230	125	140	10	208,50
4773 19 0120	12	230	125	145	10	223,75
4773 19 0130	13	230	125	150	10	241,00
4773 19 0140	14	230	125	150	10	266,50

**4773**

**1000V Süngüsü İzoleli Lokma Uçlu Tornavida Takımı (8 Parça)**  
*Nut Spinner, Electrician Blade Insulated Set (8 Pcs)*  
*1000V*



KOD CODE	İÇERİK CONTENTS	g	□	TL/Ad.
4773 00 8108	6 - 7 - 8 - 9 - 10 - 11 - 12 - 13	2225	8	1.573,75



**4783**

1000V Sngs İzoleli Manyetik Bits Tutucu Tornavida  
Screwdriver, Magnetic Bit Holder Insulated  
1000V

⚡ 1000 V  
IEC 60900



KOD CODE	mm	L mm	L1 mm	g	TL/Ad.
4783 19 6120	6.3	230	120	115	10

**8795 00 6005**

1000V İzoleli Elektrikçi Seti (5 Parça)  
1000V Insulated Tool Set (5 Pcs)



IZELTAS YOUTUBE

KOD CODE	İÇERİK CONTENTS	TL/Ad.
3020 12 6180	<b>180 mm 1000V İzoleli Elektrikçi Kombine Pense</b> Insulated Electrician Type Combination Pliers 1000V	1
3220 13 6200	<b>200 mm 1000V İzoleli Elektrikçi Kargaburun</b> Insulated Electrician Type Nose Pliers	1
3700 16 6160	<b>160 mm 1000V İzoleli Elektrikçi Yan Keski</b> Insulated Electrician Type Nose	1.308,25
4140 17 5512	<b>5.5x125 1000V Elektrikçi Dz Uçlu Tornavida</b> Insulated Electrician Type Flat Screwdriver 1000V	1
4145 18 6100	<b>6x100 1000V İzoleli Elektrikçi Yıldız Uçlu Tornavida</b> Insulated Electrician Type Phillips Screwdriver 1000V	1

**8440 00 1023**

19" Plastik Takım Çantası Elektrikçi Set ( 23 Parça)  
Plastic Tool Box for Electrician 19" (23 Pcs )



KOD CODE	İÇERİK CONTENTS	TL/Ad.
8440 33 1019	<b>19" Plastik Takım Çantası</b> Plastic Tool Box	1
3700 16 6160	<b>160 mm 1000V İzoleli Elektrikçi Yan Keski</b> Insulated Electrician Type Side Cutter 1000V	1
3020 12 6180	<b>180 mm 1000V İzoleli Elektrikçi Kombine Pense</b> Insulated Electrician Type Combination Pliers 1000V	1
3220 13 6160	<b>160 mm 1000V İzoleli Elektrikçi Kargaburun Dz Uçlu</b> Insulated Electrician Type Nose Pliers 1000V	1
4773 19 0100	<b>1000V Sngs İzoleli Lokma Uçlu Tornavida 10mm</b> Nut Spinner, Electrician Blade Insulated 1000V	1
4773 19 0130	<b>1000V Sngs İzoleli Lokma Uçlu Tornavida 13mm</b> Nut Spinner, Electrician Blade Insulated 1000V	1
3715 16 6165	<b>165mm 1000V İzoleli Elektrikçi Tek Ağız Kablo Kesici</b> Cable Cutter 1000V	1
4520 18 0360	<b>3x60 Klemens Yıldız Tornavida</b> Electronic Screwdriver, Phillips	3.025,75
4520 18 0480	<b>4x80 Klemens Yıldız Tornavida</b> Electronic Screwdriver, Phillips	1
4500 17 0380	<b>3x80 Klemens Dz Tornavida</b> Electronic Screwdriver, Flat	1
4500 17 0480	<b>4x80 Klemens Dz Tornavida</b> Electronic Screwdriver, Flat	1
4140 17 4100	<b>4x100 1000V İzoleli Elektrikçi Dz Tornavida</b> Insulated Electrician Type Flat Screwdriver 1000V	1
4145 18 4580	<b>4,5x80 1000V İzoleli Elektrikçi Yıldız Tornavida</b> Insulated Electrician Type Phillips Screwdriver 1000V	1
4145 18 6100	<b>6x100 1000V İzoleli Elektrikçi Yıldız Tornavida</b> Insulated Electrician Type Phillips Screwdriver 1000V	1
4550 17 0190	<b>190 mm Kontrol Kalem</b> Voltage Tester Flat	1
4560 18 0190	<b>190 mm Yıldız Kontrol Kalem</b> Voltage Tester Phillips	1
4783 19 6120	<b>6.3x120 1000V İzoleli Elektrikçi Manyetik Bits Tutucu Tornavida</b> Screwdriver, Magnetic Bit Holder Insulated 1000V	1
4800 00 8106	<b>6 lı Bits Set ( 25 mm )</b> Bit Set 6 Pcs	6



**İZELTAS®**

# TORNAVİDA VE ALLEN ANAHTARLAR

## SCREWDRIVERS AND HEX KEY WRENCHES

Tornavidalar  
Screwdrivers

Kontrol Kalemleri  
Testers

Bits Uçlar ve Aparatları  
Bits

Allen Anahtarlar  
Hex Key Wrenches

SCREWDRIVERS, HEX KEY  
WRENCHES

TORNAVİDALAR  
ALLEN  
ANAHTARLAR



İZELTAS YOUTUBE

**ELEKTRİK KONTROL KALEMİ/VOLTAGE TESTER**

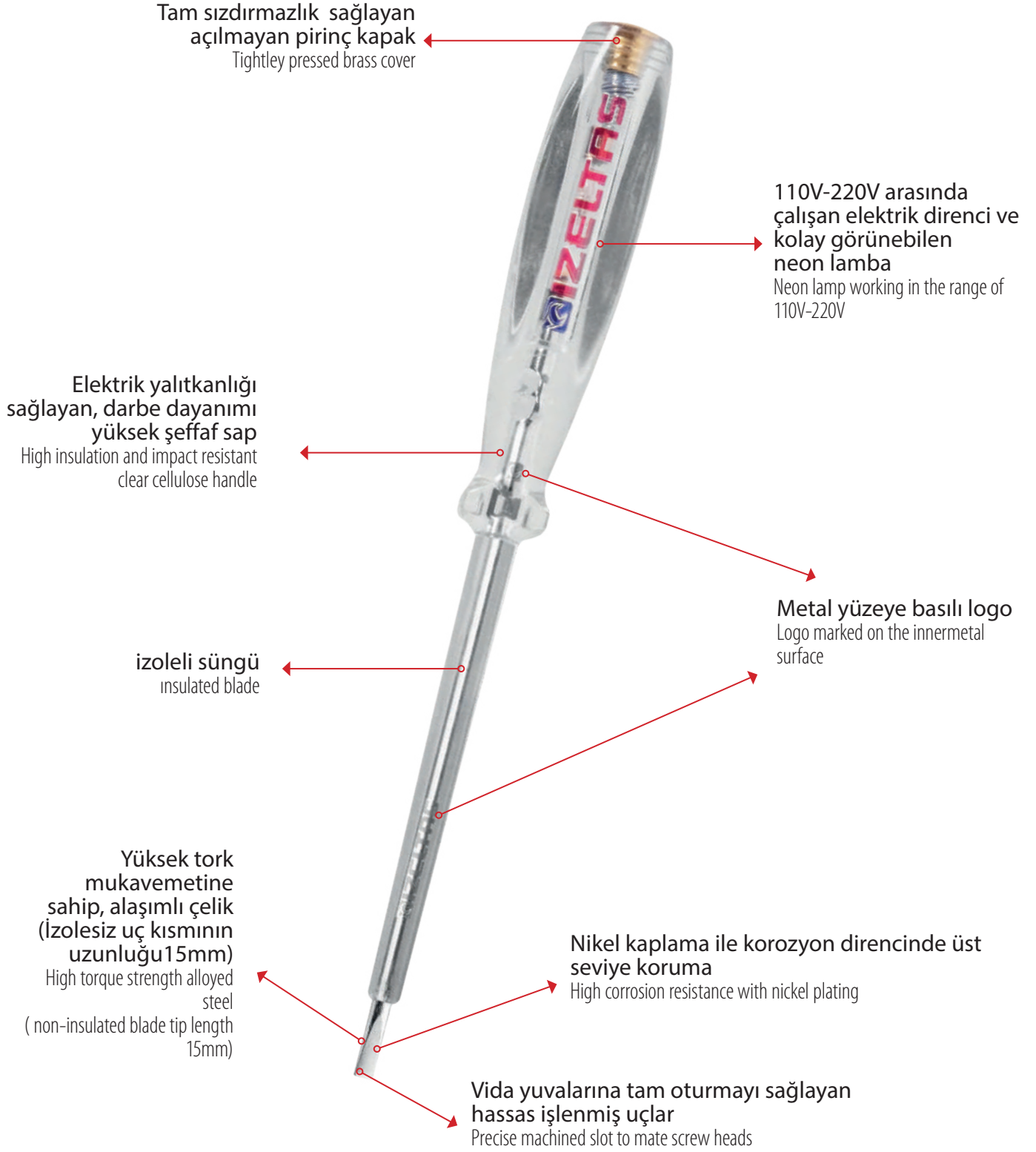

## 4550

Elektrik Kontrol Kalemi (Düz Uçlu)  
Voltage Tester (Flat)

TS 13108

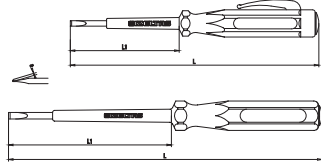

Krom vanadyum, Nikel kaplı,  
Chrom vanadium, Nickel plated,

KOD CODE	L mm	⊖		L1 mm	g	□	TL/ Ad.
		a mm	b mm				
4550 17 0135	135	0.5	3	60	20	10	47,00
4550 17 0190	190	0.8	4	100	40	10	60,00

## 4560

Elektrik Kontrol Kalemi (Yıldız Uçlu)  
Voltage Tester (Phillips)

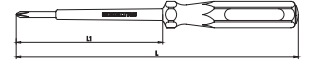
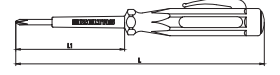

Krom vanadyum, Nikel kaplı  
Chrom vanadium, Nickel plated

KOD CODE	L mm	L1 mm	+	g	□	TL/ Ad.
4560 18 0190	190	100	Ph0	40	10	71,00

## 4555

Master Elektrik Kontrol Kalemi (Düz Uçlu)  
Voltage Tester Master (Flat)

TS 13108

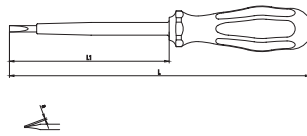

Krom vanadyum, Nikel kaplı  
Chrom vanadium, Nickel plated.

KOD CODE	L mm	⊖		L1 mm	g	□	TL/ Ad.
		a mm	b mm				
4555 17 0165	165	0.5	3.5	88	40	10	65,00

## 4565

Oto Kontrol Kalemi  
Car Voltage Tester

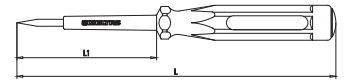

Krom vanadyum, Krom kaplı  
Chrom vanadium, Chrom plated

Tüm otomobil ve ağır vasıta araçlarda 6-24V arası elektrik tesisatının kontrol edilmesinde kullanılır. Sivri uçlu olması sebebiyle kablo ve soketleri yerinden sökmeden kontrol kolaylığı sağlar.

Tool is used to control 6-24V electrical wiring in all cars and heavy duty vehicles. With its point tip, wires and sockets are not required to be disassembled.

KOD CODE	L mm	L1 mm	●	Kablo L (m)	g	□	TL/ Ad.

**Kraft Seri Düz Uçlu Tornavida**  
*Screwdriver, Kraft, Flat*

TS ISO 2380 - 1  
DIN ISO 2380-1

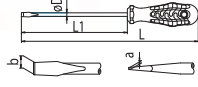

**Krom vanadyum, Krom kaplı, Ucu siyah oksit, Selüloz asetat saplı**  
*Chrom vanadium, Chrom plated and black tip, Cellulose acetate handle*

KOD CODE	øDxL1 mm	-		L mm	g	□	TL/Ad.
		a mm	b mm				
4100 17 0340	3x40	0.5	3	105	20	10	39,50
4100 17 0380	3x80	0.5	3	155	35	10	42,00
4100 17 0480	4x80	0.8	4	165	50	10	45,25
4100 17 4100	4x100	0.8	4	185	50	10	52,50
4100 17 0580	5x80	1.0	5.5	175	70	10	55,50
4100 17 5100	5x100	1.0	5.5	195	75	10	61,00
4100 17 5125	5x125	1.0	5.5	220	80	10	69,75
4100 17 5150	5x150	1.0	5.5	245	80	10	76,25
4100 17 6100	6x100	1.2	6.5	195	85	10	62,50
4100 17 6125	6x125	1.2	6.5	220	90	10	71,75
4100 17 6150	6x150	1.2	6.5	245	95	10	78,75
4100 17 6175	6x175	1.2	6.5	270	100	10	101,00
4100 17 7125	7x125	1.2	8	230	120	10	79,75
4100 17 7150	7x150	1.2	8	255	130	10	92,25
4100 17 7175	7x175	1.2	8	280	135	10	105,75
4100 17 8150	8x150	1.6	10	255	145	10	104,75
4100 17 8175	8x175	1.6	10	280	150	10	111,75
4100 17 8200	8x200	1.6	10	305	160	10	136,75
4100 17 9200	9x200	2.0	12	305	190	10	145,75
4100 17 1125	11x250	2.5	14	365	305	10	185,25



**Kraft Seri Düz Uçlu Tornavida Takımı (8 Parça)**  
*Screwdriver, Flat, Kraft Set (8 Pcs)*



KOD CODE	İÇERİK CONTENTS	g	□	TL/Ad.
4100 00 8108	3x80 - 4x80 - 4x100 5x100 - 5x125 - 6x100 6x125 - 6x150 Düz uçlu / Flat	550	8	483,50

**Kraft Seri Süngüsü Uzun Düz Uçlu Tornavida**  
*Screwdriver, Kraft, Flat, Long*

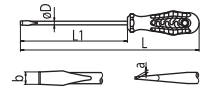

**Krom vanadyum, Krom kaplı, Ucu siyah oksit, Selüloz asetat saplı**  
*Chrom vanadium, Chrom plated and black tip, Cellulose acetate handle*

KOD CODE	øDxL1 mm	-		L mm	g	□	TL/Ad.
		a mm	b mm				
4100 17 4300	4x300	0.8	4	385	70	10	129,00
4100 17 5250	5x250	1.0	5.5	345	95	10	144,25
4100 17 5350	5x350	1.0	5.5	445	115	10	162,75
4100 17 6350	6x350	1.2	6.5	445	125	10	172,25

**4120**
**Kraft Seri Yıldız Uçlu Tornavida**  
*Screwdriver, Kraft, Phillips*

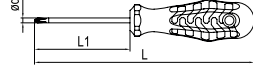
 TS 59 - 5 ISO 8764-1  
 DIN ISO 8764-1

Krom vanadyum, Krom kaplı, Ucu siyah oksit, Selüloz asetat saplı  
*Chrom vanadium, Chrom plated and black tip, Cellulose acetate handle.*

KOD CODE	ØdxL1 mm	+	L mm	g	TL/Ad.
4120 18 0360	3x60	Ph0	135	30	10 44,50
4120 18 4580	4.5x80	Ph1	165	55	10 64,00
4120 18 5100	4.5x100	Ph1	185	55	10 71,25
4120 18 5150	4.5x150	Ph1	235	60	10 85,25
4120 18 6100	6x100	Ph2	195	85	10 77,00
4120 18 6150	6x150	Ph2	245	95	10 92,25
4120 18 6200	6x200	Ph2	295	105	10 119,75
4120 18 8150	8x150	Ph3	255	150	10 146,00
4120 18 1200	10x200	Ph4	315	240	10 225,75

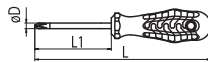
**4120**
**Kraft Seri Süngüsü Uzun Yıldız Uçlu Tornavida**  
*Screwdriver, Kraft, Phillips, Long*

Krom vanadyum, Krom kaplı, Ucu siyah oksit, Selüloz asetat saplı  
*Chrom vanadium, Chrom plated and black tip, Cellulose acetate handle*

KOD CODE	ØDxL1 mm	+	L mm	g	TL/Ad.
4120 18 5300	4.5x300	Ph1	385	80	10 201,50
4120 18 6300	6x300	Ph2	395	125	10 208,25

**4120**
**Kraft Seri Yıldız Uçlu Tornavida Takımı (6 parça)**  
*Screwdriver, Kraft, Phillips, Set (6 Pcs)*



KOD CODE	İÇERİK CONTENTS	g	TL/Ad.
4120 00 8106	 3x60 - 4.5x80 4.5x100 - 4.5x150 6x100 - 6x150 Yıldız uçlu / Phillips	380	6 434,25

**4100**
**Kraft Seri Tornavida Seti (7 parça)**  
*Screwdriver Set, Kraft (7 Pcs)*

KOD CODE	İÇERİK CONTENTS	g	TL/Ad.
4100 00 8107	 3x80 - 4x80 - 4x100 5x125 - 6x150 Düz uçlu / Flat  4.5x80 - 6x100 Yıldız uçlu / Phillips	445	7 429,25

**Kraft Seri Düz Uçlu Topaç Tornavida**  
Screwdriver, Kraft, Stubby, Flat

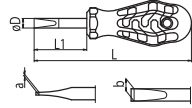
TS 59



**Krom vanadyum, Krom kaplı, Ucu siyah oksit, Selüloz asetat saplı**  
Chrom vanadium, Chrom plated and black tip,  
Cellulose acetate handle

KOD CODE	øDxL1 mm	⊖		L mm	g	TL/Ad.	
		a mm	b mm				
4110 17 5525	5.5x25	1	5.5	70	30	5	45,50
4110 17 5540	5.5x40	1	5.5	105	45	5	61,50
4110 17 6525	6.5x25	1.2	6.5	70	35	5	50,75
4110 17 6540	6.5x40	1.2	6.5	105	50	5	69,75

**Kraft Seri Yıldız Uçlu Topaç Tornavida**  
Screwdriver, Kraft, Stubby, Phillips

TS 59 -5

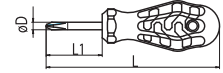

**Krom vanadyum, Krom kaplı, Ucu siyah oksit, Selüloz asetat saplı**  
Chrom vanadium, Chrom plated and black tip,  
Cellulose acetate handle

KOD CODE	øDxL1 mm	⊕	L mm	g	TL/Ad.	
						4130 18 4525
4130 18 4540	4.5x40	Ph1	105	40	5	61,25
4130 18 0625	6x25	Ph2	70	30	5	51,00
4130 18 0640	6x40	Ph2	105	50	5	69,00





## 4140

### 1000V İzoleli Elektrikçi Düz Uçlu Tornavida Insulated Electrician Type Flat Screwdriver 1000V

TS 59  
TS ISO 2380-1  
DIN ISO 2380-1  
⚡ 1000 V  
IEC 60900

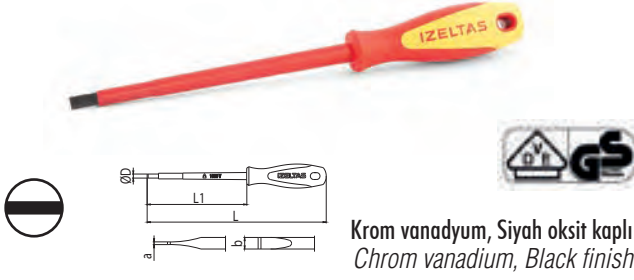

Krom vanadyum, Siyah oksit kaplı  
Chrom vanadium, Black finish

KOD CODE	øDxL1 mm	⊖		L mm	g	TL/Ad.	
		a mm	b mm				
4140 17 2575	2.5x75	0.4	2.5	150	25	10	50,75
4140 17 4100	4x100	0.8	4	185	40	10	59,50
4140 17 5512	5.5x125	1	5.5	220	70	10	78,50
4140 17 6515	6.5x150	1.2	6.5	245	90	10	87,75

## 4145

### 1000V İzoleli Elektrikçi Yıldız Uçlu Tornavida Insulated Electrician Type Phillips Screwdriver 1000V

TS 59  
TS 59-5ISO 8764  
DIN ISO 8764  
⚡ 1000 V  
IEC 60900

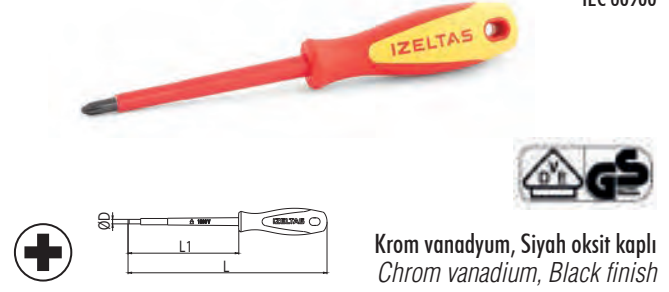

Krom vanadyum, Siyah oksit kaplı  
Chrom vanadium, Black finish

KOD CODE	øDxL1 mm	⊕	L mm	g	TL/Ad.	
						4145 18 0360
4145 18 4580	4.5x80	Ph1	165	45	10	74,50
4145 18 6100	6x100	Ph2	195	70	10	87,75

## 4140

### 1000V İzoleli Elektrikçi Tornavida Seti (6 Parça) Insulated Electrician Set (6 Pcs) Screwdriver 1000V



KOD CODE	İÇERİK CONTENTS	g	TL/Ad.
4140 00 9106	2.5x75 - 4x100	340	6
	⊖ 5.5x125 - 6.5x150		
	Düz uçlu / Flat		
	⊕ 4.5x80 - 6x100		
	Yıldız uçlu / Phillips		438,75



**Opak Seri Düz Uçlu Tornavida**  
Screwdriver, Opak, Flat

TS ISO 2380-1  
DIN ISO 2380-1

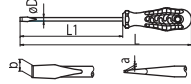

**Krom vanadyum, Krom kaplı, Ucu siyah oksit, PP saplı**  
Chrome vanadium, Chrom plated and black tip, PP handle

KOD CODE	øDxL1 mm	⊖		L mm	g	□	TL/Ad.
		a mm	b mm				
4300 17 0380	3x80	0.5	3	155	25	10	37,00
4300 17 0480	4x80	0.8	4	165	35	10	38,25
4300 17 4100	4x100	0.8	4	185	40	10	45,50
4300 17 5100	5x100	1.0	5.5	195	60	10	55,00
4300 17 5125	5x125	1.0	5.5	220	60	10	64,00
4300 17 6100	6x100	1.2	6.5	195	65	10	57,25
4300 17 6125	6x125	1.2	6.5	220	70	10	65,25
4300 17 6150	6x150	1.2	6.5	245	80	10	71,25
4300 17 7125	7x125	1.2	8	230	95	10	73,00
4300 17 7150	7x150	1.2	8	255	105	10	84,00
4300 17 8175	8x175	1.6	10	280	130	10	101,75
4300 17 9200	9x200	2.0	12	305	165	10	134,50

**Opak Seri Yıldız Uçlu Tornavida**  
Screwdriver, Opak, Phillips

TS 59 - 5 ISO 8764-1  
DIN ISO 8764

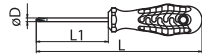

**Krom vanadyum, Krom kaplı, Ucu siyah oksit, PP saplı**  
Chrome vanadium, Chrom plated and black tip, PP handle

KOD CODE	øDxL1 mm	+	L mm	g	□	TL/Ad.
4320 18 0360	3x60	Ph0	135	25	10	40,75
4320 18 4580	4.5x80	Ph1	165	40	10	58,00
4320 18 6100	6x100	Ph2	195	70	10	70,25
4320 18 8150	8x150	Ph3	255	140	10	133,00

**Opak Seri Tornavida Seti (7 Parça)**  
Screwdriver Set, Opak (7 Pcs)



KOD CODE	İÇERİK CONTENTS	g	□	TL/Ad.
4300 00 8107	3x80 - 4x80 - 4x100	520	7	384,25
	⊖ 5x125 - 6x150			
	⊕ 4.5x80 - 6x100			
	<b>Yıldız uçlu / Phillips</b>			

**Opak Seri Pozidriv Yıldız Uçlu Tornavida**  
Screwdriver, Opak, Pozidriv

DIN ISO 8764

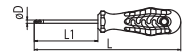

**Krom vanadyum, Krom kaplı, Ucu siyah oksit, PP saplı**  
Chrome vanadium, Chrom plated and black tip, PP handle

KOD CODE	øDxL1 mm	+	L mm	g	□	TL/Ad.
4325 18 0360	3x60	Pz0	135	25	10	44,50
4325 18 4580	4.5x80	Pz1	165	40	10	64,00
4325 18 6100	6x100	Pz2	195	70	10	77,00
4325 18 8150	8x150	Pz3	255	140	10	146,00



SCREWDRIVERS, HEXKEY  
WRENCHES

TORNANTLALAR  
ALLEN  
ANHTARLAR

**4240**

**Değişken Uçlu Tornavida**  
*Screwdriver - Reversible*

TSEK



**Krom vanadyum, Krom kaplı, Selüloz asetat saplı**  
*Chrom vanadium, Chrom plated, Cellulose acetate handle*

KOD CODE	øDxL1 mm	-		L mm	g	TL/Ad.	
		a mm	b mm				
4240 17 0680	6x80	1.2x6	Ph2	175	80	10	80,50

**4240**

**Değişken Uçlu Tornavida Takımı**  
*Screwdriver Set - Reversible*

TSEK



KOD CODE	øDxL1 mm	-		L mm	g	TL/Ad.	
		a mm	b mm				
4240 00 7102	6x80	1.2x6	Ph2	175	105	1	138,00
	4.5x80	0.65x4.5	Ph1				

**4500**

**Elektronikçi Tip (Klemens) Düz Uçlu Tornavida**  
*Electronic Screwdriver, Flat*



**Krom vanadyum, Krom kaplı, Ucu siyah oksit, PP saplı**  
*Chrome vanadium, Chrom plated and black tip, PP handle*

KOD CODE	øDxL1 mm	-		L mm	g	TL/Ad.	
		a mm	b mm				
4500 17 2560	2.5x60	0.4	2.5	140	15	10	35,75
4500 17 2580	2.5x80	0.4	2.5	160	15	10	37,50
4500 17 0380	3x80	0.5	3	160	15	10	39,75
4500 17 3100	3x100	0.5	3	180	20	10	48,50
4500 17 3125	3x125	0.5	3	205	20	10	64,00
4500 17 3510	3.5x100	0.6	3.5	180	20	10	50,00
4500 17 0480	4x80	0.8	4	160	20	10	40,75
4500 17 4100	4x100	0.8	4	180	20	10	50,00
4500 17 4125	4x125	0.8	4	205	25	10	67,25
4500 17 4150	4x150	0.8	4	230	25	10	73,25

**4520**

**Elektronikçi Tip (Klemens) Yıldız Uçlu Tornavida**  
*Electronic Screwdriver, Phillips*



**Krom vanadyum, Krom kaplı, Ucu siyah oksit, PP saplı**  
*Chrome vanadium, Chrom plated and black tip, PP handle*

KOD CODE	øDxL1 mm	+	L mm	g	TL/Ad.	
4520 18 0360	3x60	Ph0	140	15	10	42,00
4520 18 0480	4x80	Ph0	160	20	10	60,25
4520 18 4150	4x150	Ph0	230	25	10	80,25

**4500**

**Elektronikçi Tip (Klemens) Tornavida Seti (6 Parça)**  
*Electronic Screwdriver Set (6 Pcs)*



KOD CODE	İÇERİK CONTENTS	g	TL/Ad.
4500 00 8106	3x80 - 3x100	115	6
	3x125 - 4x150		
	<b>Düz uçlu / Flat</b> 3x60 - 4x80		
	<b>Yıldız uçlu / Phillips</b>		

**4530**

Elektronikçi Tip (Klemens) Torx® Uçlu Tornavida  
Electronic Screwdriver, Torx®

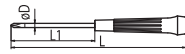

Krom vanadyum, Krom kaplı, Ucu siyah oksit, PP saplı  
Chrome vanadium, Chrom plated and black tip, PP handle

KOD CODE	øDxL1 mm	*	L mm	g	TL/Ad.
4530 17 0560	2.5x60	T5	145	15	10 48,50
4530 17 0660	2.5x60	T6	145	15	10 48,50
4530 17 0760	3x60	T7	145	15	10 50,25
4530 17 0860	3x60	T8	145	20	10 50,25
4530 17 0960	3x60	T9	145	20	10 50,25
4530 17 1060	3.5x60	T10	145	20	10 50,25

**4530**

Elektronikçi Tip (Klemens) Torx® Uçlu Tornavida Takımı (6 Parça)  
Electronic Screwdriver Set Torx (6 Pcs)



KOD CODE	İÇERİK CONTENTS	g	TL/Ad.
4530 00 1006	T5 - T6 - T7 - T8 - T9 - T10	115	6 298,00

**4540**

Klips Sökme Tornavidası  
Hupcap and Clip Remover

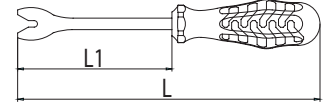

Krom vanadyum, Krom kaplı, PP Saplı  
Chrom vanadium, Chrom plated, PP insulated

KOD CODE	L mm	L1	g	TL/Ad.
4540 19 0190	290	180	160	10 189,25

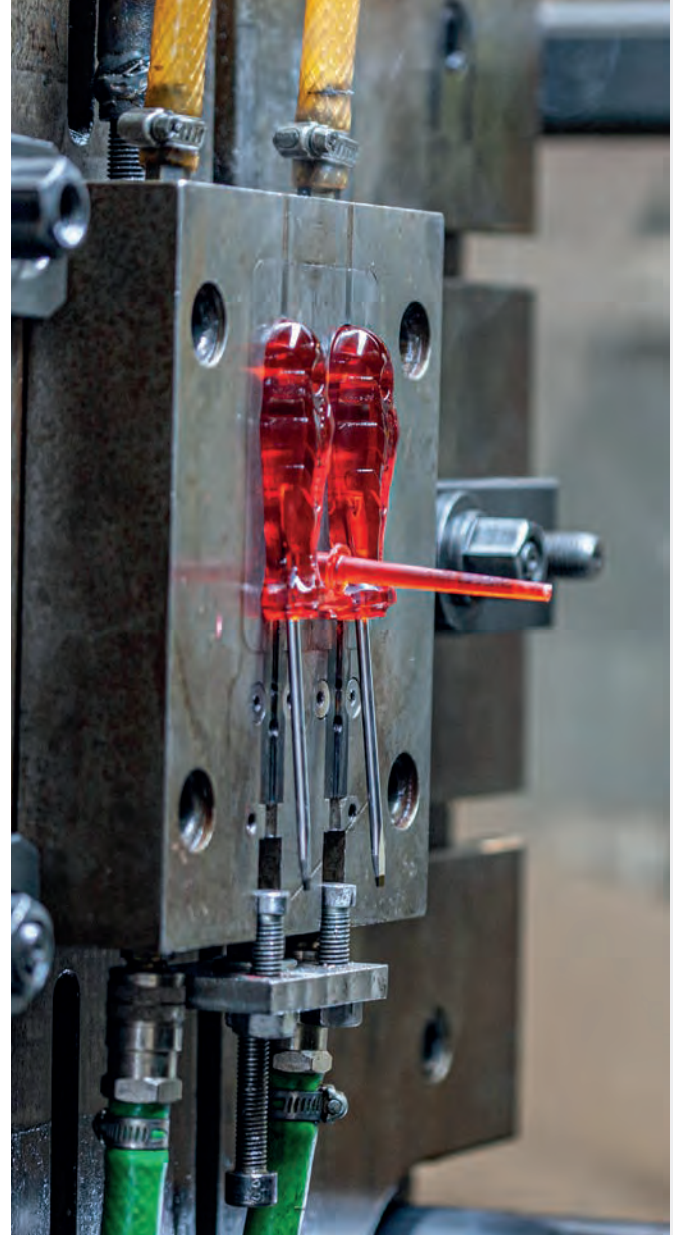

**T Tipi Lokma Uçlu Tornavida (mm)**  
*Nut Spinner With T-Handle (mm)*



**Krom vanadyum, Krom kaplı, PP Saplı**  
*Chrom vanadium, Chrom plated, PP insulated*

KOD CODE	mm	L mm	L1 mm	g		TL/Ad.
4765 19 0040	4	185	135	75	10	102,25
4765 19 0050	5	185	135	75	10	102,25
4765 19 0055	5.5	185	135	75	10	102,25
4765 19 0060	6	185	135	75	10	102,25
4765 19 0070	7	185	135	90	10	109,00
4765 19 0080	8	185	135	95	10	109,00
4765 19 0090	9	185	135	100	10	121,00
4765 19 0100	10	185	135	100	10	121,00
4765 19 0110	11	185	135	110	10	133,75
4765 19 0120	12	185	135	110	10	138,00
4765 19 0130	13	185	135	115	10	144,50
4765 19 0140	14	185	135	115	10	168,00

**Lokma Uçlu Tornavida (mm)**  
*Nut Spinner (mm)*

DIN 3125



**Krom vanadyum, Krom kaplı, PP Saplı**  
*Chrom vanadium, Chrom plated, PP insulated*

KOD CODE	mm	L mm	L1 mm	g		TL/Ad.
4770 19 0040	4	220	125	80	10	116,25
4770 19 0050	5	220	125	80	10	116,25
4770 19 0055	5.5	220	125	80	10	116,25
4770 19 0060	6	220	125	80	10	116,25
4770 19 0070	7	230	125	100	10	125,00
4770 19 0080	8	230	125	110	10	125,00
4770 19 0090	9	230	125	115	10	134,75
4770 19 0100	10	230	125	115	10	134,75
4770 19 0110	11	230	125	130	10	147,25
4770 19 0120	12	230	125	135	10	157,75
4770 19 0130	13	230	125	140	10	170,00
4770 19 0140	14	230	125	140	10	188,00



**Lokma Uçlu Tornavida Takımı (8 Parça, mm)**  
*Nut Spinner Set (8 Pcs, mm)*



KOD CODE	İÇERİK CONTENTS	g		TL/Ad.
4770 00 8108	6 - 7 - 8 - 9 - 10 - 11 - 12 - 13	2145	8	1.110,75

**4773**

1000V Sngs İzoleli Lokma Uçlu Tornavida  
Nut Spinner, Electrician Blade Insulated 1000V

DIN 3125  
⚡ 1000 V  
IEC 60900



Krom vanadyum, İki Komponent Saplı  
Chrome vanadium, Two Component Insulated

KOD CODE	mm	L mm	L1 mm	g		TL/Ad.
4773 19 0040	4	220	125	90	10	165,00
4773 19 0050	5	220	125	90	10	165,00
4773 19 0055	5.5	220	125	90	10	165,00
4773 19 0060	6	220	125	90	10	165,00
4773 19 0070	7	230	125	110	10	176,75
4773 19 0080	8	230	125	120	10	176,75
4773 19 0090	9	230	125	125	10	191,00
4773 19 0100	10	230	125	125	10	191,00
4773 19 0110	11	230	125	140	10	208,50
4773 19 0120	12	230	125	145	10	223,75
4773 19 0130	13	230	125	150	10	241,00
4773 19 0140	14	230	125	150	10	266,50

**4775**

Torx® Uçlu Tornavida  
Torx® Screwdriver

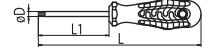

Krom vanadyum, Krom kaplı, Ucu siyah oksit, PP saplı  
Chrome vanadium, Chrom plated and blackened, PP handle

KOD CODE	ØDxL1 mm	Star	L mm	g		TL/Ad.
4775 18 0010	4x80	T10	165	35	10	57,75
4775 18 0015	4x80	T15	165	35	10	57,75
4775 18 0020	4x100	T20	185	40	10	64,00
4775 18 0025	4.5x100	T25	185	40	10	74,25
4775 18 0027	5x125	T27	220	60	10	81,75
4775 18 0030	6x125	T30	220	70	10	86,75
4775 18 0040	7x125	T40	230	100	10	108,00
4775 18 0045	8x125	T45	230	120	10	122,00

**4773**

1000V Sngs İzoleli Lokma Uçlu Tornavida Takımı (8 Parça)  
Nut Spinner, Electrician Blade Insulated Set (8 Pcs)  
1000V



KOD CODE	İÇERİK CONTENTS	g		TL/Ad.
4773 00 8108	6 - 7 - 8 - 9 - 10 - 11 - 12 - 13	2225	8	1.573,75

**4775**

Torx® Uçlu Tornavida Takımı (7 Parça)  
Torx® Screwdriver Set (7 Pcs)



KOD CODE	İÇERİK CONTENTS	g		TL/Ad.
4775 00 8107	T10 - T15 - T20 - T25 - T27 - T30 - T40	380	7	530,25

**4776**

Delikli Torx® Uçlu Tornavida  
Torx® Screwdriver / Tamper Resistance

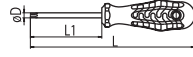

Krom vanadyum, Krom kaplı, Ucu siyah oksit, PP saplı  
Chrome vanadium, Chrom plated and blackened, PP handle

KOD CODE	ØDxL1 mm	☆	L mm	g	□	TL/Ad.
4776 18 0009	4x60	TR9	145	35	10	75,00
4776 18 0010	4x80	TR10	165	35	10	77,50
4776 18 0015	4x80	TR15	165	40	10	77,50
4776 18 0020	4x100	TR20	185	40	10	86,50
4776 18 0025	4.5x100	TR25	185	45	10	99,75
4776 18 0027	5x125	TR27	220	60	10	110,00
4776 18 0030	6x125	TR30	220	70	10	117,00
4776 18 0040	7x125	TR40	230	100	10	145,00

**4776**

Delikli Torx® Uçlu Tornavida Takımı (7 Parça)  
Torx® Screwdriver / Tamper Resistance Set (7 Pcs)



KOD CODE	İÇERİK CONTENTS	g	□	TL/Ad.
4776 00 8107	TR10 - TR15 - TR20 - TR25 - TR27 TR30 - TR40	380	7	713,25

**4780**

Manyetik Bits Tutucu Tornavida (Uzun)  
Screwdriver, Magnetic Bit Holder (Long)



KOD CODE	○ mm	L mm	L1 mm	g	□	TL/Ad.
4780 19 6120	6.3	230	120	105	10	150,00

**4783**

1000V Süngüsü İzoleli Manyetik Bits Tutucu Tornavida  
Screwdriver, Magnetic Bit Holder Insulated  
1000V

△ 1000 V  
IEC 60900



KOD CODE	○ mm	L mm	L1 mm	g	□	TL/Ad.
4783 19 6120	6.3	230	120	115	10	185,50

**4785**

Manyetik Bits Tutucu Tornavida (Kısa)  
Screwdriver, Magnetic Bit Holder, (Short)



KOD CODE	○ mm	L mm	L1 mm	g	□	TL/Ad.
4785 19 6330	6.3	130	30	60	10	81,75

**4790**

Üniversal Bits Adaptörü (Manyetik)  
Screwdriver Universal Bit Holder (Magnetic)



KOD CODE	mm	○ mm	L mm	g	□	TL/Ad.
4790 26 6360	6.3	6.3	60	25	10	71,50



**4795**

T Tipi Manyetik Bits Tutucu Tornavida  
Magnetic Bit Holder With T-Handle



KOD CODE	mm	L mm	L1 mm	g		TL/Ad.
4795 19 0010	6.3	180	130	60	10	158,75

**4788**

Manyetik Bits Tutucu Tornavida, Flexible  
Screwdriver, Magnetic Bit Holder, Flexible



KOD CODE	mm	L mm	L1 mm	g		TL/Ad.
4788 19 6160	6.3	285	175	130	10	311,00

**4805**

Bits Uç Lokma Adaptörü (Makine Kullanımına Uygun)  
Socket Adapter



KOD CODE		L mm	g		TL/Ad.
4805 20 5010	1/4"M - 1/4"M	50	20	10	25,75
4805 20 5011	1/4"M - 1/2"M	50	25	10	52,25

**4815**

Değişken Bits Uçlu Tornavida Set (7 parça)  
Screwdriver - Interchangeable Bits Set (7 pcs)



KOD CODE	İÇERİK CONTENTS	g		TL/Ad.
4815 00 6107	100mm Sap Ph1x4.5 - Ph2x5.5 - Ph3x7 Pz1x4.5 - Pz2x5.5 - Pz3x7	140	7	172,50

**4800**

6'lı Bits Set  
Bit Set (6 Pcs)



KOD CODE	İÇERİK CONTENTS	g		TL/Ad.
4800 00 8106	0.6x4.5 - 0.8x5.5	50	6	58,50
	Ph1 - Ph2 - Ph3			
	T27			

**4800**

10'lu Bits Set  
Bit Set (10 Pcs)



KOD CODE	İÇERİK CONTENTS	g		TL/Ad.
4800 00 8110	0.6x4.5 - 0.8x5.5 1.2x6.5	55	10	108,25
	Ph1 - Ph2 - Ph3			
	T25 - T27 - T30 - T40			

**4800**

31'li Bits Set (Plastik Kutulu)  
Bit Set In Plastic Case  
(31 Pcs)



KOD CODE	İÇERİK CONTENTS	g		TL/Ad.
4800 00 8131	0.6x4.5 - 0.8x5.5	385	6-6	364,00
	1.2x6.5			
	Ph1			
	Ph2 - Ph3			
	T27			
	T25 - T30 - T40			
6.3 x 60 Adaptör	1			

## 4810-4860

### Düz Bits Uçlar

Bits Flat

25mm-50mm-75mm-100mm-150mm



Krom vanadyum  
Chrom vanadium

KOD CODE	☯	L mm	g	□	TL/Ad.
4810 20 0645	0.6x4.5	25	5	10	8,50
4810 20 0855	0.8x5.5	25	5	10	8,50
4810 20 1265	1.2x6.5	25	5	10	8,50
4810 20 5645	0.6x4.5	50	10	10	14,25
4810 20 5855	0.8x5.5	50	10	10	14,25
4810 20 5265	1.2x6.5	50	10	10	14,25
4860 20 0745	0.6x4.5	75	11	10	21,50
4860 20 0755	0.8x5.5	75	13	10	21,50
4860 20 0765	1.2x6.5	75	15	10	21,50
4860 20 1045	0.6x4.5	100	14	10	32,25
4860 20 1055	0.8x5.5	100	17	10	32,25
4860 20 1065	1.2x6.5	100	18	10	32,25
4860 20 1545	0.6x4.5	150	21	10	46,00
4860 20 1555	0.8x5.5	150	26	10	46,00
4860 20 1565	1.2x6.5	150	28	10	46,00

## 4820-4870

### Yıldız Bits Uçlar

Bits Phillips

25mm-50mm-75mm-100mm-150mm



Krom vanadyum  
Chrom vanadium

KOD CODE	⊕	L mm	g	□	TL/Ad.
4820 21 0001	Ph1	25	5	10	9,25
4820 21 0002	Ph2	25	5	10	9,25
4820 21 0003	Ph3	25	5	10	9,25
4820 21 0011	Ph1	50	10	10	16,50
4820 21 0012	Ph2	50	10	10	16,50
4820 21 0013	Ph3	50	10	10	16,50
4870 21 0701	Ph1	75	17	10	22,25
4870 21 0702	Ph2	75	18	10	22,25
4870 21 0703	Ph3	75	18	10	22,25
4870 21 1001	Ph1	100	20	10	34,25
4870 21 1002	Ph2	100	24	10	34,25
4870 21 1003	Ph3	100	24	10	34,25
4870 21 1501	Ph1	150	23	10	48,25
4870 21 1502	Ph2	150	33	10	48,25
4870 21 1503	Ph3	150	33	10	48,25

## 4810

### Düz Bits Takımı (25 mm)

Flat Bit Set (25 mm)



KOD CODE	☯	g	□	TL/Ad.
4810 00 0645	0.6x4.5	45	10	85,00
4810 00 0855	0.8x5.5	50	10	85,00
4810 00 1265	1.2x6.5	55	10	85,00

## 4820

### Yıldız Bits Takımı (25 mm)

Phillips Bit Set (25 mm)



KOD CODE	⊕	g	□	TL/Ad.
4820 00 0001	Ph1	50	10	92,50
4820 00 0002	Ph2	50	10	92,50
4820 00 0003	Ph3	55	10	92,50

## 4825-4880

### Pozidriv Bits Uçlar

Bits Pozidriv

25mm-50mm-75mm-100mm-150mm



Krom vanadyum  
Chrom vanadium

KOD CODE	+	L mm	g	□	TL/Ad.
4825 21 0001	Pz1	25	5	10	10,00
4825 21 0002	Pz2	25	5	10	10,00
4825 21 0003	Pz3	25	5	10	10,00
4825 21 0011	Pz1	50	10	10	17,50
4825 21 0012	Pz2	50	10	10	17,50
4825 21 0013	Pz3	50	10	10	17,50
4880 21 0701	Pz1	75	17	10	22,75
4880 21 0702	Pz2	75	18	10	22,75
4880 21 0703	Pz3	75	18	10	22,75
4880 21 1001	Pz1	100	20	10	34,50
4880 21 1002	Pz2	100	24	10	34,50
4880 21 1003	Pz3	100	24	10	34,50
4880 21 1501	Pz1	150	23	10	49,50
4880 21 1502	Pz2	150	33	10	49,50
4880 21 1503	Pz3	150	33	10	49,50

## 4825

### Pozidriv Bits Takımı (25 mm)

Pozidriv Bit Set (25 mm)



KOD CODE	+	g	□	TL/Ad.
4825 00 0001	Pz1	50	10	100,00
4825 00 0002	Pz2	55	10	100,00
4825 00 0003	Pz3	55	10	100,00

## 4830-4885

### Torx® Bits Uçlar

Bits Torx®

25mm-50mm-75mm-100mm-150mm



Krom vanadyum  
Chrom vanadium

KOD CODE	☆	L mm	g	□	TL/Ad.
4830 21 0025	T25	25	5	10	13,75
4830 21 0027	T27	25	5	10	13,75
4830 21 0030	T30	25	5	10	13,75
4830 21 0040	T40	25	5	10	13,75
4830 21 0125	T25	50	10	10	17,50
4830 21 0127	T27	50	10	10	17,50
4830 21 0130	T30	50	10	10	17,50
4830 21 0140	T40	50	10	10	17,50
4885 21 0725	T25	75	12	10	24,25
4885 21 0727	T27	75	15	10	24,25
4885 21 0730	T30	75	15	10	24,25
4885 21 0740	T40	75	17	10	24,25
4885 21 1025	T25	100	15	10	35,00
4885 21 1027	T27	100	20	10	35,00
4885 21 1030	T30	100	20	10	35,00
4885 21 1040	T40	100	23	10	35,00
4885 21 1525	T25	150	20	10	50,25
4885 21 1527	T27	150	25	10	50,25
4885 21 1530	T30	150	25	10	50,25
4885 21 1540	T40	150	33	10	50,25

## 4830

### Torx® Bits Takımı (25 mm)

Torx® Bit Set (25 mm)



KOD CODE	☆	g	□	TL/Ad.
4830 00 0025	T25	50	10	137,50
4830 00 0027	T27	50	10	137,50
4830 00 0030	T30	55	10	137,50
4830 00 0040	T40	60	10	137,50

**4784**

1/4" Avuç İçi Bits Tutucu  
Palm Ratchet Bit Holder



**YENİ  
NEW**

KOD CODE	Ø	L mm	g	TL/Ad.
4784 19 6346	46	26,5	100	5 289,00

**4850**

100mm Uzun Bits Uç Takımı (13 Parça)  
Bit Set, Long Type 100 mm (13 Pcs)



**100mm**

KOD CODE	İÇERİK CONTENTS	g	TL/Ad.
4850 00 1013	<b>Düz Uçlar</b> Flat Bits 0.6x4.5 - 0.8x 5.5 1.2x6.5	263	13 443,00
	<b>Yıldız Uçlar</b> Phillips Bits Ph1 - Ph2 - Ph3		
	<b>Pozidriv Uçlar</b> Pozidriv Bits Pz1 - Pz2 - Pz3		
	<b>Torx® Uçlar</b> Torx® Bits T25 - T27 - T30 - T40		

**4850**

75mm Uzun Bits Uç Takımı (13 Parça)  
Bit Set, Long Type 75 mm (13 Pcs)



**75mm**

KOD CODE	İÇERİK CONTENTS	g	TL/Ad.
4850 00 0713	<b>Düz Uçlar</b> Flat Bits 0.6x4.5 - 0.8x 5.5 1.2x6.5	204	13 296,50
	<b>Yıldız Uçlar</b> Phillips Bits Ph1 - Ph2 - Ph3		
	<b>Pozidriv Uçlar</b> Pozidriv Bits Pz1 - Pz2 - Pz3		
	<b>Torx® Uçlar</b> Torx® Bits T25 - T27 T30 - T40		

**4850**

150mm Uzun Bits Uç Takımı (13 Parça)  
Bit Set, Long Type 150 mm (13 Pcs)



**150mm**

KOD CODE	İÇERİK CONTENTS	g	TL/Ad.
4850 00 1513	<b>Düz Uçlar</b> Flat Bits 0.6x4.5 - 0.8x 5.5 1.2x6.5	356	13 632,25
	<b>Yıldız Uçlar</b> Phillips Bits Ph1 - Ph2 - Ph3		
	<b>Pozidriv Uçlar</b> Pozidriv Bits Pz1 - Pz2 - Pz3		
	<b>Torx® Uçlar</b> Torx® Bits T25 - T27 - T30 - T40		

## 4900

### Allen Anahtar Altı Köşe (mm) Hex Key Wrench (mm)

TS ISO 2936  
DIN ISO 2936

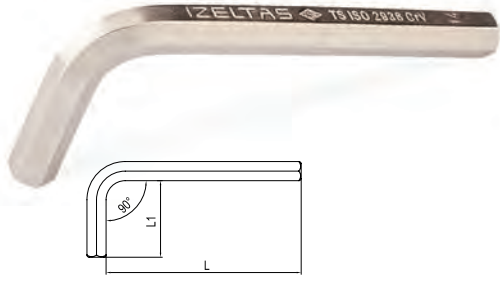

Krom Vanadyum, Nikel Kaplı  
Chrom Vanadium, Nickel Plated

KOD CODE	mm	L mm	L1 mm	g	TL/Ad.	
4900 22 0015	1.5	45	14	1.5	10	5,00
4900 22 0020	2	50	16	2	10	7,25
4900 22 0025	2.5	56	18	4	10	9,00
4900 22 0030	3	63	20	6	10	9,75
4900 22 0035	3.5	66	22	8	10	12,25
4900 22 0040	4	70	25	10	10	12,50
4900 22 0050	5	80	28	20	10	14,50
4900 22 0060	6	90	32	30	10	19,00
4900 22 0070	7	95	34	40	10	28,00
4900 22 0080	8	100	36	55	10	32,25
4900 22 0090	9	105	38	75	10	39,75
4900 22 0100	10	112	40	100	10	49,00
4900 22 0120	12	125	45	160	10	71,00
4900 22 0140	14	140	56	250	5	113,50
4900 22 0160	16	152	60	375	5	209,25
4900 22 0170	17	160	63	425	5	225,75
4900 22 0190	19	180	70	610	5	279,00
4900 22 0220	22	200	80	940	5	465,75
4900 22 0240	24	224	90	1250	5	628,75

## 4900

### Allen Anahtar Takım Altı Köşe (mm) Hex Key Wrench Set (mm)



KOD CODE	İÇERİK CONTENTS	g	TL/Ad.	
4900 00 3110	2 - 2.5 - 3 - 4 - 5 - 6 7 - 8 - 9 - 10	400	10	221,00
4900 00 3112	2 - 2.5 - 3 - 3.5 - 4 - 5 6 - 7 - 8 - 9 - 10 - 12	565	12	304,25

## 4901

### Allen Anahtar Altı Köşe (SAE) Hex Key Wrench (SAE)

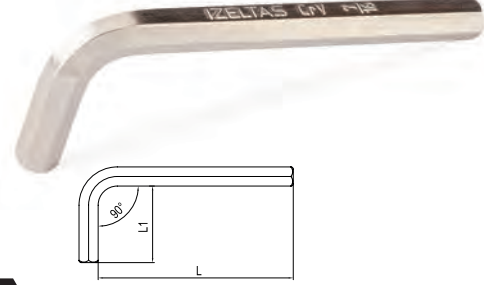

Krom Vanadyum, Nikel Kaplı  
Chrom Vanadium, Nickel Plated

KOD CODE	inch	L mm	L1 mm	g	TL/Ad.	
4901 22 1984	5/64"	50	16	2	10	9,75
4901 22 2381	3/32"	54	18	4	10	10,50
4901 22 3125	1/8"	58	20	5	10	12,75
4901 22 3968	5/32"	62	22	10	10	15,50
4901 22 4762	3/16"	68	24	15	10	16,00
4901 22 5556	7/32"	74	26	25	10	21,25
4901 22 6350	1/4"	82	28	35	10	26,00
4901 22 7937	5/16"	94	32	55	10	32,25
4901 22 9825	3/8"	106	38	90	10	44,50
4901 22 1111	7/16"	118	42	130	10	59,75
4901 22 1270	1/2"	132	46	190	10	75,25
4901 22 1428	9/16"	144	52	265	10	109,75
4901 22 1587	5/8"	156	58	365	10	170,50
4901 22 1905	3/4"	176	66	600	5	238,50

## 4901

### Allen Anahtar Takım Altı Köşe (SAE) Hex Key Wrench Set (SAE)



KOD CODE	İÇERİK CONTENTS	g	TL/Ad.	
4901 00 3110	5/64" - 3/32" - 1/8" - 5/32" 3/16" - 7/32" - 1/4" - 5/16" 3/8" - 7/16"	405	10	248,25
4901 00 3112	5/64" - 3/32" - 1/8" - 5/32" 3/16" - 7/32" - 1/4" - 5/16" 3/8" - 7/16" - 1/2" - 9/16"	855	12	433,25

## 4903

Allen Anahtar Altı Köşe Uzun Boy (mm)  
Hex Key Wrench Long Pattern (mm)

TS ISO 2936  
DIN ISO 2936



Krom Vanadyum, Nikel Kaplı  
Chrom Vanadium, Nickel Plated

KOD CODE	mm	L mm	L1 mm	g		TL/ Ad.
4903 22 0020	2	100	16	3	10	10,50
4903 22 0025	2.5	112	18	5	10	12,25
4903 22 0030	3	126	20	10	10	14,00
4903 22 0035	3.5	136.5	22	15	10	17,25
4903 22 0040	4	140	25	20	10	17,75
4903 22 0050	5	160	28	30	10	19,75
4903 22 0060	6	180	32	50	10	32,25
4903 22 0070	7	190	34	80	10	47,75
4903 22 0080	8	200	36	100	10	52,00
4903 22 0090	9	210	38	145	10	70,50
4903 22 0100	10	224	40	180	10	87,25
4903 22 0120	12	250	45	285	10	125,50
4903 22 0140	14	280	56	460	5	202,25
4903 22 0160	16	290	60	625	5	327,00
4903 22 0170	17	320	63	750	5	356,25
4903 22 0190	19	360	70	1100	5	527,75

## 4903

Allen Anahtar Takım Altı Köşe Uzun Boy (mm)  
Hex Key Wrench Set Long Pattern (mm)



KOD CODE	İÇERİK CONTENTS	g		TL/Ad.
4903 00 3110	2 - 2.5 - 3 - 4 - 5 - 6 7 - 8 - 9 - 10	660	10	364,00
4903 00 3112	2 - 2.5 - 3 - 3.5 - 4 - 5 6 - 7 - 8 - 9 - 10 - 12	940	12	506,75

## 4905

Yuvarlak Başlı Allen Anahtar (mm)  
Hex Key Wrench Ballpoint (mm)



Krom Vanadyum, Nikel Kaplı  
Chrom Vanadium, Nickel Plated

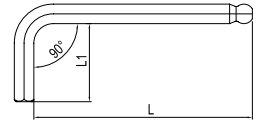

KOD CODE	mm	L mm	L1 mm	g		TL/ Ad.
4905 22 0020	2	50	16	3	10	11,75
4905 22 0025	2.5	56	18	4	10	14,25
4905 22 0030	3	63	20	5	10	16,25
4905 22 0040	4	70	25	10	10	20,00
4905 22 0050	5	80	28	20	10	21,00
4905 22 0060	6	90	32	30	10	34,00
4905 22 0080	8	100	36	55	10	52,25
4905 22 0100	10	112	40	100	10	83,00

## 4905

Yuvarlak Başlı Allen Anahtar Takımı (8 Parça, mm)  
Hex Key Wrench Ballpoint Set (8 Pcs, mm)



KOD CODE	İÇERİK CONTENTS	g		TL/Ad.
4905 00 7108	2 - 2.5 - 3 - 4 5 - 6 - 8 - 10	275	8	252,50

## 4906

**Yuvarlak Başlı Allen Anahtar Uzun Boy (mm)**  
Hex Key Wrench Ballpoint Long Pattern (mm)

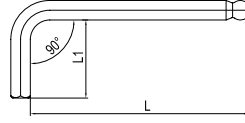

**Krom Vanadyum, Nikel Kaplı**  
Chrom Vanadium, Nickel Plated

KOD CODE	mm	L mm	L1 mm	g	TL/Ad.	
4906 22 0015	1.5	79	12	1.5	10	15,75
4906 22 0020	2	84	16	3	10	21,00
4906 22 0025	2.5	89	16	5	10	22,75
4906 22 0030	3	99	18	7	10	24,50
4906 22 0040	4	109	23	13	10	28,00
4906 22 0050	5	125	26	25	10	35,25
4906 22 0060	6	150	28	42	10	40,50
4906 22 0080	8	167	33	85	10	64,25
4906 22 0100	10	190	37	150	10	95,50

## 4906

**Yuvarlak Başlı Allen Anahtar Takım Altı Köşe Uzun Boy (9 parça, mm)**  
Hex Key Wrench Ballpoint Long Pattern Set (9 Pcs, mm)



KOD CODE	İÇERİK CONTENTS	g	TL/Ad.	
4906 00 3109	1.5 - 2 - 2.5 - 3 - 4 - 5 - 6 8 - 10	355	9	347,50

## 4910

**Torx® Allen Anahtar**  
Torx® Key Wrench

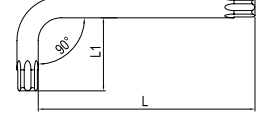

**Krom Vanadyum, Nikel Kaplı**  
Chrom Vanadium, Nickel Plated

KOD CODE	☆	L mm	L1 mm	g	TL/Ad.	
4910 22 0006	T6	42	16	2	10	49,25
4910 22 0007	T7	48	16	2	10	49,25
4910 22 0008	T8	48	16	3	10	49,25
4910 22 0009	T9	48	16	3	10	49,50
4910 22 0010	T10	51	17	4	10	49,50
4910 22 0015	T15	54	18	5	10	51,00
4910 22 0020	T20	57	19	5	10	53,50
4910 22 0025	T25	60	20	10	10	53,50
4910 22 0027	T27	64	21	15	10	53,50
4910 22 0030	T30	70	24	20	10	57,25
4910 22 0040	T40	76	26	30	10	61,00
4910 22 0045	T45	83	29	40	10	74,75
4910 22 0050	T50	95	32	60	10	85,00
4910 22 0055	T55	108	35	125	10	118,00
4910 22 0060	T60	120	38	185	10	162,50

## 4910

**Torx® Allen Anahtar Takımı (8 Parça)**  
Torx® Key Wrench Set (8 Pcs)

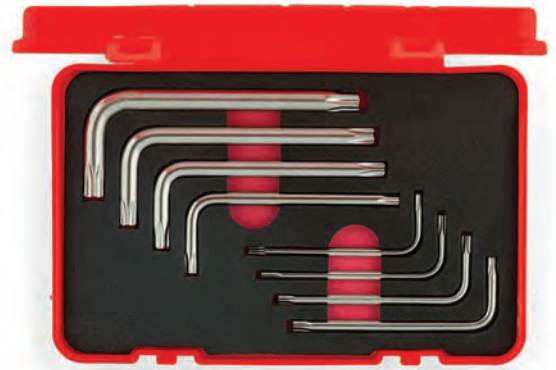

KOD CODE	İÇERİK CONTENTS	g	TL/Ad.	
4910 00 7108	T9 - T10 - T15 T20 - T25 - T27 T30 - T40	155	8	428,75

**4912**

**Kaset Allen Anahtar Takımı (7 Parça, mm)**  
*Hex Key Wrench Folding Set (7 Pcs, mm)*



**Krom vanadyum**  
*Chrom vanadium*

KOD CODE	İÇERİK CONTENTS	g	TL/Ad.
4912 00 3107	2.5 - 3 - 4 - 5 - 6 - 8 - 10	355	1 434,00

**4912**

**Kaset Allen Anahtar Takımı (7 Parça, mm)**  
*Hex Key Wrench Folding Set (7 Pcs, mm)*



**Krom vanadyum**  
*Chrom vanadium*

KOD CODE	İÇERİK CONTENTS	g	TL/Ad.
4912 00 0007	1.5 - 2 - 2.5 3 - 4 - 5 - 6	130	1 275,00

**4909**

**T Tipi Torx® Allen Anahtar**  
*T Handle Torx® Key*

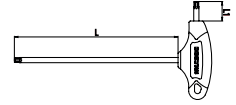

**Krom vanadyum, Nikel kaplı**  
*Chrom vanadium, Nickel plated*

KOD CODE	☆	L1 mm	L2 mm	g	TL/Ad.
4909 22 0009	T9	125	15	22	5 125,50
4909 22 0010	T10	125	15	22	5 128,00
4909 22 0015	T15	125	15	26	5 130,75
4909 22 0020	T20	125	15	44	5 131,75
4909 22 0025	T25	150	20	49	5 134,75
4909 22 0027	T27	150	20	62	5 149,75
4909 22 0030	T30	150	20	82	5 154,00
4909 22 0040	T40	175	25	100	5 159,75

**4909**

**T Tipi Torx Allen Anahtar Takımı (8 Parça)**  
*T Handle Torx Key Wrench Set (8 Pcs)*



KOD CODE	İÇERİK CONTENTS	g	TL/Ad.
4909 00 8108	T9 - T10 - T15 - T20 T25 - T27 - T30 - T40	407	8 1.114,25



## 4920

### T Tipi Allen Anahtar (mm) Hex Key Wrench T - Handle (mm)

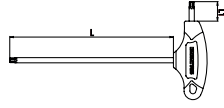

Krom Vanadyum  
Chrom Vanadium



KOD CODE	mm	L mm	L1 mm	g	TL/Ad.
4920 22 0025	2.5	110	14	20	5 67,75
4920 22 0030	3	125	17	23	5 69,00
4920 22 0040	4	140	20	45	5 77,50
4920 22 0050	5	155	23	58	5 82,75
4920 22 0060	6	170	26	100	5 94,50
4920 22 0070	7	185	30	125	5 99,25
4920 22 0080	8	200	34	150	5 116,50
4920 22 0100	10	220	40	240	5 176,50

## 4921

### T Tipi Yuvarlak Başlı Allen Anahtar (mm) Hex Key Wrench T - Handle Ballpoint (mm)

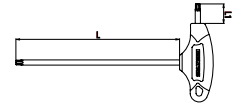

Krom Vanadyum  
Chrom Vanadium



KOD CODE	mm	L mm	L1 mm	g	TL/Ad.
4921 22 0025	2.5	110	14	20	5 88,00
4921 22 0030	3	125	17	23	5 89,25
4921 22 0040	4	140	20	45	5 100,00
4921 22 0050	5	155	23	58	5 107,25
4921 22 0060	6	170	26	100	5 122,75
4921 22 0070	7	185	30	125	5 128,50
4921 22 0080	8	200	34	150	5 138,25
4921 22 0100	10	220	40	235	5 229,25

## 4920

### T Tipi Allen Anahtar Takımı (8 Parça, mm) Hex Key Wrench T - Handle Set (8 Pcs, mm)



KOD CODE	İÇERİK CONTENTS	g	TL/Ad.
4920 00 8108	2.5 - 3 - 4 - 5 6 - 7 - 8 - 10	760	8 783,75

## 4921

### T Tipi Yuvarlak Başlı Allen Anahtar Takımı (8 Parça, mm) Hex Key Wrench T - Handle Ballpoint Set (8 Pcs, mm)



KOD CODE	İÇERİK CONTENTS	g	TL/Ad.
4921 00 8108	2.5 - 3 - 4 5 - 6 - 7 - 8 - 10	755	8 1.003,25

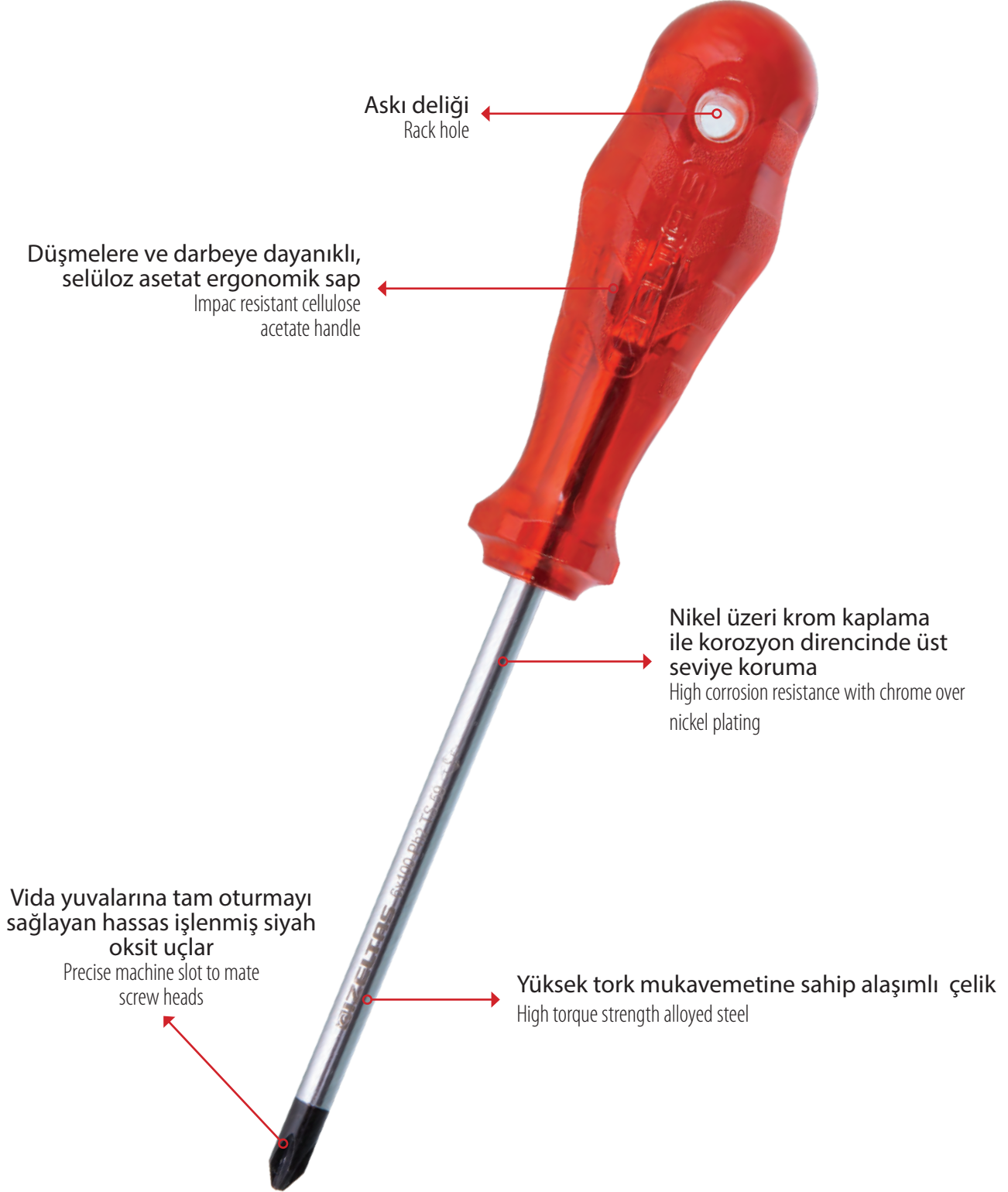

**IZELTAS**<sup>®</sup>

# KESKİLER VE ÇEKİÇLER

## CHISELS AND HAMMERS

Keskiler  
Chisels

Zimbalar  
Punches

Çekiçler  
Hammers

Keserler  
Adzes



CHISELS AND HAMMERS

KESKİLER  
ÇEKİÇLER



Darbeyi eşit olarak dağıtmaya yarayan yuvarlak çelik kama  
Steel wedge to equally distribute impact

İndüksiyonda sertleştirilmiş darbe yüzeyleri  
Induction hardened impact surfaces

Yüksek karbonlu sıcak dövme çeliği ile artırılmış dayanım  
High carbon, hot forged steel

Sapın çıkmasını engelleyen epoksi yapıştırıcı  
Epoxy glue to prevent handle separation

İndüksiyonda sertleştirilmiş darbe yüzeyleri  
Induction hardened impact surfaces

Sap-gövde birleşiminden kırılmayı önleyen çelik yüzük  
Steel bushing to prevent breakage at the head and handle connection area

Dişbudak ağacından üretilmiş, el ergonomisine uygun özel tasarımlı, vernikli ahşap sap  
Ergonomic special design handle produced from strong ash tree hardwood



İZELTAŞ USTA İŞİ  
SOHBETLER

## 5010

### Iskarpela (Düz) Wood Chisel

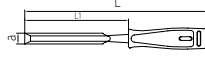

Özel alaşımli çelik, Uç induksiyonda sertleştirilmiş, PP Saplı  
Special steel, Induction hardened tips, PP Handle

KOD CODE	a mm	L mm	L1 mm	g	TL/Ad.	
5010 23 0006	6	240	120	115	5	125,25
5010 23 0008	8	242	122	125	5	133,75
5010 23 0010	10	244	124	135	5	141,25
5010 23 0012	12	246	126	135	5	155,00
5010 23 0014	14	248	128	145	5	160,25
5010 23 0016	16	250	130	150	5	171,50
5010 23 0018	18	252	132	160	5	186,00
5010 23 0020	20	254	134	170	5	206,75
5010 23 0022	22	256	136	190	5	224,00
5010 23 0024	24	258	138	195	5	242,00
5010 23 0026	26	260	140	200	5	250,75
5010 23 0030	30	264	144	205	5	267,75

## 5010

### Iskarpela Takım (6 parça) Wood Chisel Set (6 Pcs)



KOD CODE	İÇERİK CONTENTS	g	TL/Ad.	
5010 00 8106	10 - 12 - 14 16 - 18 - 20	985	6	1.020,75

## 5500

### Düz Keski Flat Cold Chisel

TS 492  
DIN 6453



Özel alaşımli çelik, Krom kaplı  
Special steel, Chrom plated

KOD CODE	L mm	a mm	g	TL/Ad.	
5500 23 0100	100	17	75	5	75,00
5500 23 0125	125	19	110	5	90,25
5500 23 0150	150	21	180	5	116,00
5500 23 0175	175	24	245	5	130,75
5500 23 0200	200	27	340	5	182,00
5500 23 0250	250	30	525	5	223,75
5500 23 0300	300	30	635	5	358,50

## 5500

### Düz Keski (Kalkan İzoleli) Flat Cold Chisel (With Safety Handle)

TS 492  
DIN 6453

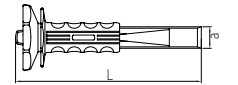

Özel alaşımli çelik, Krom kaplı  
Special steel, Chrom plated

KOD CODE	L mm	a mm	g	TL/Ad.	
5500 23 1250	250	30	700	1	284,75
5500 23 1300	300	30	790	1	415,00

## 5510

Tesviyeci Düz Keski  
Flat Cold Chisel Octagonal

TS 492  
DIN 6453



Krom vanadyum, Krom kaplı  
Chrom vanadium, Chrom plated

KOD CODE	L mm	a mm	g	TL/Ad.
5510 23 0125	125	10	75	102,75
5510 23 0150	150	14	125	128,25

## 5520

Tırnak Keski  
Cross Cut Chisel

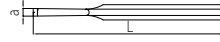

Krom vanadyum, Krom kaplı  
Chrom vanadium, Chrom plated

KOD CODE	L mm	a mm	g	TL/Ad.
5520 23 0125	130	5	70	115,25
5520 23 0150	150	6	110	137,25

## 5540

Nokta Zimba  
Center Punch

DIN 7250

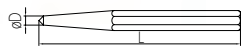

Krom vanadyum, Elektrostatik boyanmış  
Chrom vanadium, Electrostatically painted

KOD CODE	L mm	L inch	σD mm	g	TL/Ad.
5540 24 4120	120	4 3/4"	4	65	86,75
5540 24 5120	120	4 3/4"	5	95	102,25
5540 24 5150	150	6"	5	115	113,25
★5540 24 0412	120	4 3/4"	4	65	85,75

★ Krom Kaplı / Chrom Plated

## 5545

Konik Pim Zimba  
Drift Punch

DIN 6458

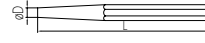

Krom vanadyum, Elektrostatik boyanmış  
Chrom vanadium, Electrostatically painted

KOD CODE	L mm	L inch	σD mm	g	TL/Ad.
5545 24 0002	120	4 3/4"	2	90	74,75
5545 24 0003	120	4 3/4"	3	90	81,25
5545 24 0004	120	4 3/4"	4	90	91,50
5545 24 0005	120	4 3/4"	5	95	93,25
5545 24 0006	120	4 3/4"	6	95	137,50
5545 24 0007	120	4 3/4"	7	100	143,25
5545 24 0008	150	6"	8	125	148,75
5545 24 0009	150	6"	9	130	152,25
5545 24 0010	150	6"	10	130	155,25
5545 24 0012	150	6"	12	180	162,25
★5545 24 0103	120	4 3/4"	3	90	85,00

## 5550

Düz Pim Zimba  
Split Pin Punch

DIN 6450

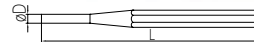

Krom vanadyum, Elektrostatik boyanmış  
Chrom vanadium, Electrostatically painted

KOD CODE	L mm	L inch	σD mm	g	TL/Ad.
5550 24 0002	150	6"	2	70	107,00
5550 24 0003	150	6"	3	65	107,00
5550 24 0004	150	6"	4	65	108,75
5550 24 0005	150	6"	5	65	108,75
5550 24 0006	150	6"	6	70	109,75
5550 24 0007	150	6"	7	100	114,25
5550 24 0008	150	6"	8	105	122,25
5550 24 0009	150	6"	9	110	124,00
5550 24 0010	150	6"	10	120	125,25
★5550 24 0105	150	6"	5	65	95,50

## 5550

Düz Pim Zimba Takımı (6 Parça)  
Split Pin Punch (6 Pcs)



KOD CODE	İÇERİK CONTENTS	g	TL/Ad.
5550 00 1006	3 - 4 - 5 - 6 - 7 - 8	865	670,75

## 5600 00 6106

Keski Zımba Seti (6 Parça)  
Chisel And Punch Set (6 Pcs)



KOD CODE	İÇERİK CONTENTS	g		TL/Ad.
5510 23 0125	<b>125 Tevsiyecii Düz Keski</b> 125 Flat Cold Chisel Octagonal	865	6	612,50
5510 23 0150	<b>150 Tevsiyecii Düz Keski</b> 150 Flat Cold Chisel Octagonal			
5520 23 0125	<b>130 Tırnak Keski</b> 130 Cross Cut Chisel			
5540 24 0412	<b>4x120 Nokta Zımba</b> 4x120 Center Punch			
5550 24 0105	<b>5x150 Düz Pim Zımba</b> 5x150 Split PinPunch			
5545 24 0103	<b>3x120 Konik Pim Zımba</b> 3x120 Drift Punch			



## 5700

Kayış Zımba  
Belt Punch

DIN 7200  
TSEK



Krom vanadyum, Elektrostatik boyanmış  
Chrom vanadium, Electrostatically painted

KOD CODE	ØD mm	L mm	g		TL/Ad.
5700 24 0003	3	105	35	10	64,00
5700 24 0004	4	105	40	10	67,00
5700 24 0005	5	110	50	10	72,75
5700 24 0006	6	110	60	10	74,25
5700 24 0007	7	115	75	10	81,75
5700 24 0008	8	115	90	10	86,75
5700 24 0009	9	120	100	10	96,75
5700 24 0010	10	120	110	10	103,25
5700 24 0011	11	125	130	5	111,00
5700 24 0012	12	125	165	5	132,75
5700 24 0013	13	130	165	5	139,75
5700 24 0014	14	130	180	5	153,50
5700 24 0015	15	135	245	5	176,00
5700 24 0016	16	135	300	5	192,75
5700 24 0017	17	140	365	5	210,75
5700 24 0018	18	140	380	5	229,75
5700 24 0019	19	145	405	5	249,75
5700 24 0020	20	145	450	5	266,00

## 5700

Kayış Zımba Takımı  
Belt Punch Set

TSEK



KOD CODE	İÇERİK CONTENTS	g		TL/Ad.
5700 00 2110	3 - 4 - 5 - 6 - 7 8 - 9 - 10 - 11 - 12	845	10	890,25
5700 00 2112	3 - 4 - 5 - 6 - 7 - 8 - 9 10 - 11 - 12 - 13 - 14	1180	12	1.183,50

**5800**

Tesviyeci Çekiç  
Machinist Hammer

TS 5-1  
DIN 1041  
TSE



İZELTAS YOUTUBE

Yedek parça sayfa 203  
Spare parts page 203

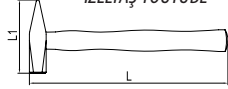

Özel alaşımlı çelik, İndüksiyonda sertleştirilmiş, Elektrostatik boyanmış  
Special steel, Induction hardened, Electrostatically painted

KOD CODE	L mm	L1 mm	g	g	TL/Ad.
5800 25 0100	260	82	100	160	10 139,25
5800 25 0200	280	95	200	260	10 151,75
5800 25 0300	300	105	300	395	10 183,75
5800 25 0500	320	118	500	600	5 212,75
5800 25 1000	360	135	1000	1095	5 307,50
5800 25 1500	380	145	1500	1630	5 403,75
5800 25 2000	400	155	2000	2100	5 496,50

**5850**

Plastik Çekiç  
Plastic Hammer

TS 5  
TSE

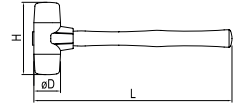

Yedek parça sayfa 203  
Spare parts page 203

Darbeye dayanıklı, Kolay değiştirilebilir başlık  
Durable and easily changeable heads

KOD CODE	L mm	øD mm	H mm	g	TL/Ad.
5850 25 0030	300	30	100	345	5 199,00
5850 25 0040	320	40	110	645	5 242,25
5850 25 0050	350	50	120	1015	5 307,00

**5810**

Emniyet Çekici  
Safety Hammer

TS 5-1

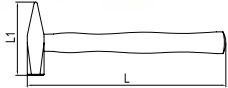

Özel alaşımlı çelik, İndüksiyonda sertleştirilmiş, Elektrostatik boyanmış  
Special steel, Induction hardened, Electrostatically painted

KOD CODE	L mm	L1 mm	g	g	TL/Ad.
5810 25 1000	360	135	1000	1095	5 401,00
5810 25 1500	380	145	1500	1630	5 554,75
5810 25 2000	400	155	2000	2100	5 685,25

**Emniyet çekici**

Çekiç kafası ile sapın birleşiminde yuvarlak kama ve yapışkan malzeme kullanılarak sağlamlığı artırılmış ayrıca birleşimi çelik sac malzeme ile desteklenerek güvenli kullanım sağlanmıştır.

**Safety Hammer**

Connection between the hammer head and the handle is ensured by circular wedge and epoxy glue, while it is also reinforced by sheet metal for safe use.

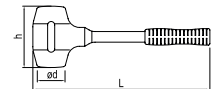

**5870**

Lastik Çekiç  
Rubber Hammer



KOD CODE	L mm	ød mm	h mm	g	g	TL/Ad.
5870 25 0400	300	47	104	400	610	5 385,50

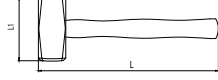

**5865**
**Madırğa**  
*Mallet*

**Yedek parça sayfa 203**  
*Spare parts page 203*
**Özel alaşımli çelik**  
*Special steel*

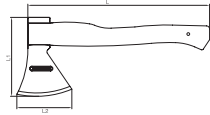
KOD CODE	L mm	L1 mm				TL/Ad.
5865 25 1000	260	95	1000	1210	5	367,50
5865 25 1500	280	110	1500	1770	5	438,75

**6410**
**Nacak**  
*Hatchet*

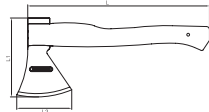
**Yedek parça sayfa 203**  
*Spare parts page 203*
**Özel alaşımli çelik, İndüksiyonda sertleştirilmiş, Elektrostatik boyanmış**  
*Special steel, Induction hardened, Electrostatically painted*

KOD CODE	L mm	L1 mm	L2 mm				TL/Ad.
6410 25 0800	380	165	115	800	1065	1	733,50

**13000 005248**
**Kamp Baltası**  
*Hatchet*
**YENİ**  
**NEW**

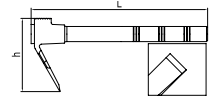
**Özel alaşımli çelik, Elektrostatik boyanmış**  
*Special steel, Electrostatically painted*

KOD CODE	L mm	L1 mm	L2 mm				TL/Ad.
13000 005248	270	118	85	600	600	1	606,50

**6400**
**Keser**  
*Adze*

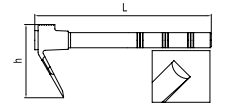
**Yedek parça sayfa 203**  
*Spare parts page 203*
**Özel alaşımli çelik, İndüksiyonda sertleştirilmiş, Elektrostatik boyanmış, PVC ağız koruyucu**  
*Special steel, Induction hardened, Electrostatically painted, PVC cutting edge protector*

KOD CODE	L mm	h mm				TL/Ad.
6400 25 0600	400	125	400	550	5	405,00

**6401**
**Usta Keseri**  
*Master Adze*

**Yedek parça sayfa 203**  
*Spare parts page 203*
**Özel alaşımli çelik, İndüksiyonda sertleştirilmiş, Elektrostatik boyanmış, PVC ağız koruyucu**  
*Special steel, Induction hardened, Electrostatically painted, PVC cutting edge protector*

KOD CODE	L mm	h mm				TL/Ad.
6401 25 0600	400	125	400	540	5	405,00



# GENEL EL ALETLERİ

## GENERAL HAND TOOLS

Servis Aletleri  
Service Equipment

Perçin Tabancası  
Riveting Pliers

İşkenceler  
Clamps

İnşaat Ekipmanları  
Construction Equipment

Metreler  
Measuring Tapes

Mengene  
Forged Steel Vice

Su Terazisi  
Straight Level

Gres Pompası  
Grease Gun



**KABLO SIYIRICI (KANCA BIÇAKLI) / CABLE STRIPPER (WITH HOOKED BLADE)**

Tüm standart kabloları  
sıyırmak için daha uzun ömür,  
daha hızlı kesme ve daha az  
aşınma sağlayan özel  
titanyum nitrür (TIN)  
kaplama  
Tin plated long lasting/fast cutting blade to  
strip all standard cables

Özel alışılmış çelikten  
sertleştirilmiş ve kaplanmış  
kanca bıçak  
Plated special alloy hardened steel hook blade

Kapasite 8-28mm  
çaplı kablolar  
için uygun  
Suitable for 8-28mm  
diameter cables

Özel kaydırmaz formu  
dayanıklı polyamid (PA) sap  
Non-slip and durable  
polyamid handle

Çevirerek kolay  
bıçak yükseklik ayarı  
Easy-to-rotate blade height adjuster

**03750**

**Kablo Sıyrıcı ( Kanca Bıçaklı )**  
Cable Stripper (With Hooked Blade)



 Yedek parça sayfa 203  
Spare parts page 203

KOD CODE	ÖLÇÜ SIZE	g	TL/Ad.
03750 50 020	Ø8-28	79	5 278,50

**03753**

**Mekanik Kablo Sıyrıcı**  
Mechanical Cable Stripper



KOD CODE	ÖLÇÜ SIZE	g	TL/Ad.
03753 50 054	0.2/6	100	5 476,25

**03752**

**Kablo Sıyrıcı**  
Cable Stripper



 Yedek parça sayfa 203  
Spare parts page 203



İZELTAS YOUTUBE

KOD CODE	ÖLÇÜ SIZE	g	TL/Ad.
03752 50 625	Ø4-16	70	5 253,50

**05881**

**Krom Şerit Metre**  
Chrom Steel Case, Measuring tapes



KOD CODE	ÖLÇÜ SIZE M	g	TL/Ad.
05881 50 013	3	160	5 134,00
05881 50 015	5	220	5 151,25

**03751**

**Koaksiyel Kablo Sıyrıcı**  
Coaxial Cable Stripper



İZELTAS YOUTUBE

KOD CODE	ÖLÇÜ SIZE	g	TL/Ad.
03751 50 012	Dış (1) İç (2)	20	5 361,50

**05881**

**Plastik Şerit Metre**  
Plastic Steel Case, Measuring tapes



KOD CODE	ÖLÇÜ SIZE M	g	TL/Ad.
05881 50 003	3	145	5 112,75
05881 50 005	5	200	5 135,25

**05886**

Arazi Tipi Fiberglas Şerit Metre (Saplı)  
Fiberglass Measuring Tape Field Type (With Holder)



KOD CODE	ÖLÇÜ SIZE M	g		TL/Ad.
05886 50 020	20	520	1	271,50
05886 50 030	30	585	1	290,00
05886 50 050	50	820	1	465,75

**05880**

Su Terazisi  
Straight Level



Alüminyum gövde  
Aluminyum body

KOD CODE	L mm	g		TL/Ad.
05880 50 040	400	250	5	405,25
05880 50 050	500	300	5	439,50
05880 50 060	600	350	5	477,75
05880 50 070	700	400	5	513,00
05880 50 080	800	450	5	554,25
05880 50 100	1000	500	5	631,00
05880 50 120	1200	550	5	746,50
05880 50 150	1500	600	5	860,25
05880 50 200	2000	800	5	1.201,75

**05887**

Kumpas  
Vernier



Sürgülü, Stoplu  
Sliding and with stop

KOD CODE	L mm	g		TL/Ad.
05887 50 150	150	155	5	978,00

**05890**

Testere Kolu  
Hacksaw Frame



Yedek parça sayfa 204  
Spare parts page 204

KOD CODE	L mm	g		TL/Ad.
05890 50 830	300	540	5	423,75

**6735**

Dal Budama Testeresi  
Pruning Saw



Yedek parça sayfa 204  
Spare parts page 204

KOD CODE	L mm	g		TL/Ad.
6735 27 0300	300	400	5	424,50

**14000 004238**

Katlanabilir Budama Testeresi  
Foldable Pruning Saw

YENİ  
NEW



KOD CODE	L mm	g		TL/Ad.
14000 004238	120	155	5	355,00

## 05901

Sentil (20 Parça, mm)  
Feeler Gauges (20 Pcs, mm)



KOD CODE	ÖLÇÜ SIZE mm	g	TL/Ad.
05901 50 020	0.05 - 1	90	10 89,50

## 6195

Perçin Tabancası  
Riveting Pliers



KOD CODE	ÖLÇÜ SIZE	CAPACITY mm	g	TL/Ad.
6195 26 0260	260	2 - 2.5 - 3 - 3.2	625	1 447,00

## 05902

Sentil (20 Parça, SAE)  
Feeler Gauges (20 Pcs, SAE)



KOD CODE	ÖLÇÜ SIZE inch	g	TL/Ad.
05902 50 020	2 - 35/1000"	65	10 139,75

## 6220

Spiralli Mıknatıs  
Flexible Magnet Holder

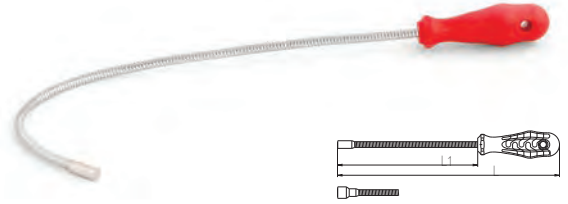

KOD CODE	KAPASİTE g	L mm	L1 mm	g	TL/Ad.
6220 26 0500	500	465	375	100	10 281,25
6220 26 1000	1000	465	375	105	10 298,00

## 6225

Madeni Yağdanlık (Flexible Uçlu)  
Oiler With Flexible Spout



KOD CODE	ÖLÇÜ SIZE cc	g	TL/Ad.
6225 26 0200	200	170	5 149,25
6225 26 0300	300	200	5 168,00
6225 26 0500	500	225	5 184,25

**LEVYE OLUKLU KIVRIK UÇLU / TYRE LEVER BENT**

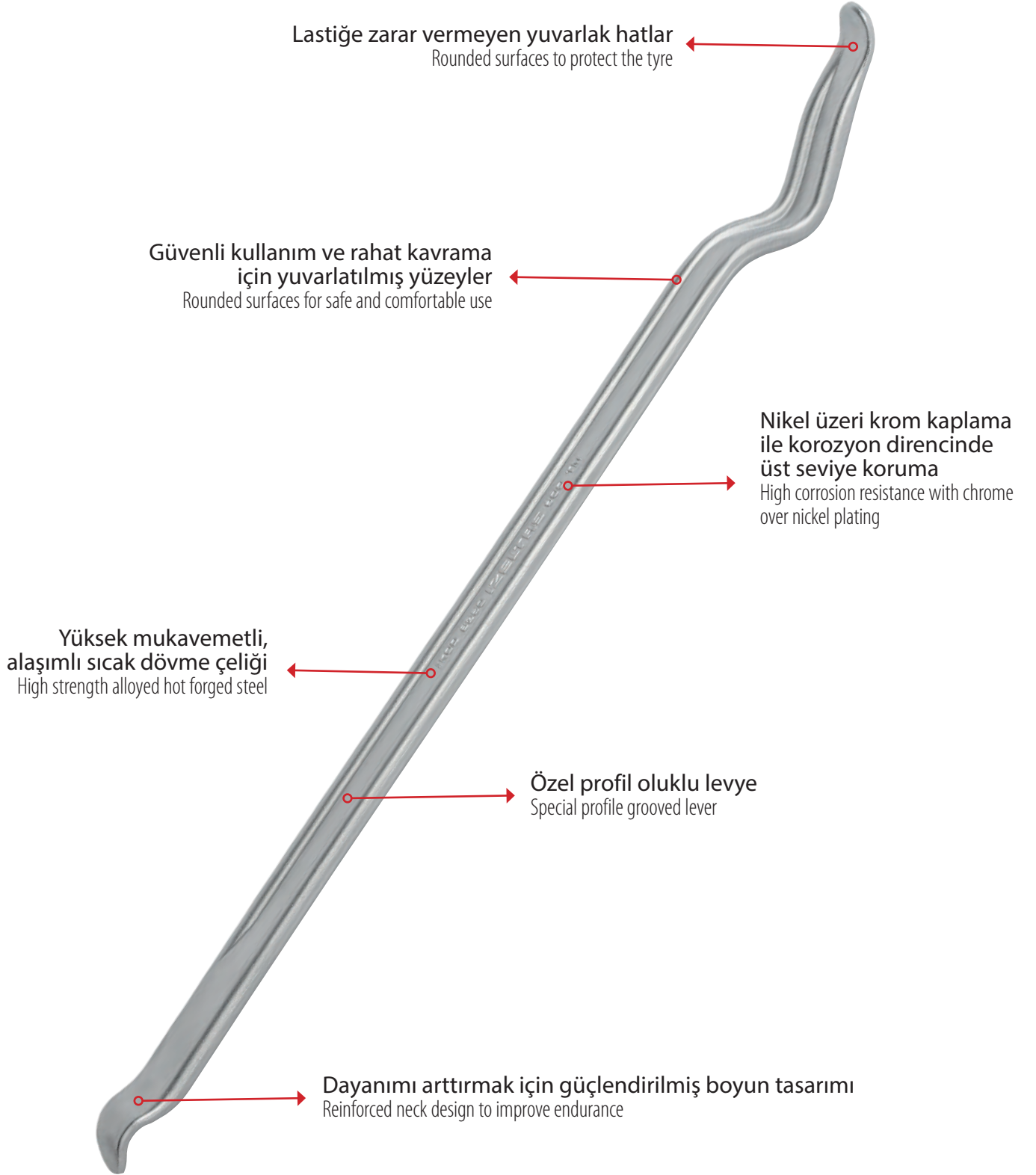



**6230**

Gres Pompası  
Grease Gun



 Yedek parça sayfa 204  
Spare parts page 204

KOD CODE	ÖLÇÜ SIZE cc	g	TL/Ad.
6230 26 0300	300	1200	1 362,00
6230 26 0500	500	1320	1 445,75

**6240**

Tapı Anahtarı (iki ağız)  
Offset Wrench For Carter Case



KOD CODE	ÖLÇÜ mm	g	TL/Ad.
6240 26 0810	8x10	250	10 141,50

**6350**

Leve Oluklu  
Tyre Lever, Straight



Krom vanadyum, Krom kaplı  
Chrom vanadium, Chrom plated

KOD CODE	L mm	L inch	g	TL/Ad.
6350 26 0300	300	12"	265	5 134,25
6350 26 0400	400	16"	440	5 169,25
6350 26 0500	500	20"	675	5 235,25
6350 26 0600	600	24"	900	5 287,25

**6360**

Leve Oluklu Kıvrık Uçlu  
Tyre Lever, Bent



Krom vanadyum, Krom kaplı  
Chrom vanadium, Chrom plated

KOD CODE	L mm	L inch	g	TL/Ad.
6360 26 0600	600	24"	910	5 317,50

**6370**

Yağ Filtresi Sökeceği  
Band Type Oil Filter Wrench



KOD CODE	Ø mm	g	TL/Ad.
6370 26 0100	75 - 100	335	5 209,75



**6375**

Çift Yönlü Üç Ayaklı Yağ Filtresi Sökeceği  
Left and Right Hand Operation, Triple Leg Oil Filter Wrench

**3/8" - 1/2"**

KOD CODE	Ø mm	g	TL/Ad.
6375 26 6512	75-120	605	5 733,50

**06374**

Zincirli Yağ Filtresi Sökeceği  
Chain Wrench



KOD CODE	Ø mm	g	TL/Ad.
06374 50 140	60x140	390	5 443,00

**6380**

Çift Zincirli Yağ Filtresi Sökeceği  
Oil Filter Wrench With Double Chain



KOD CODE	Ø mm	g	TL/Ad.
6380 26 6016	60-160	380	5 1.986,25

**06373**

Kayıslı Yağ Filtresi Sökeceği  
Strap Wrench



KOD CODE	Ø mm	g	TL/Ad.
06373 50 140	60x140	245	5 514,00

**06375**

Ayarlı Yağ Filtresi Sökeceği  
Adjustable Slot Type Oil Filter Wrench



 Yedek parça sayfa 203  
Spare parts page 203

KOD CODE	Ø mm	g	TL/Ad.
06375 50 100	65-110	215	5 245,50

## 06390

Segman Çemberi  
Piston Ring Compressor



KOD CODE	Ø mm	g	□	TL/Ad.
06390 50 125	125	235	5	438,25
06390 50 175	175	505	5	836,25

## 07415

Sıralı Tel Fırça (Ağaç Saplı)  
Hand Brush (Wooden Handle)



KOD CODE	ÖLÇÜ SIZE	g	□	TL/Ad.
07415 50 003	3 SIRA 3 RAWS	125	5	32,50
07415 50 004	4 SIRA 4 RAWS	135	5	34,25
07415 50 005	5 SIRA 5 RAWS	145	5	38,25
07415 50 006	6 SIRA 6 RAWS	170	5	41,00

## 07416

Kıvrık Uçlu Fırça (Plastik Saplı)  
Hand Brush (PP Handle)



KOD CODE	L mm	g	□	TL/Ad.
07416 50 001	270	110	5	50,75

## 07410

Makaralı Uzatma Kablosu  
(El Tipi)  
Extension Cord Reel  
(With Handle)



Kablo / Cable ø 3x1.5 mm

KOD CODE	MODEL	ÖLÇÜ SIZE	g	□	TL/Ad.
07410 50 010	el tipi / with handle	10	1400	1	1.013,75

## 07410

Makaralı Uzatma Kablosu  
(Ayaklı)  
Extension Cord Reel  
(With Stand)



Kablo / Cable ø 3x1.5 mm

KOD CODE	MODEL	ÖLÇÜ SIZE	g	□	TL/Ad.
07410 50 025	ayaklı / with stand	25	4130	1	1.791,50
07410 50 050	ayaklı / with stand	50	6745	1	3.577,25

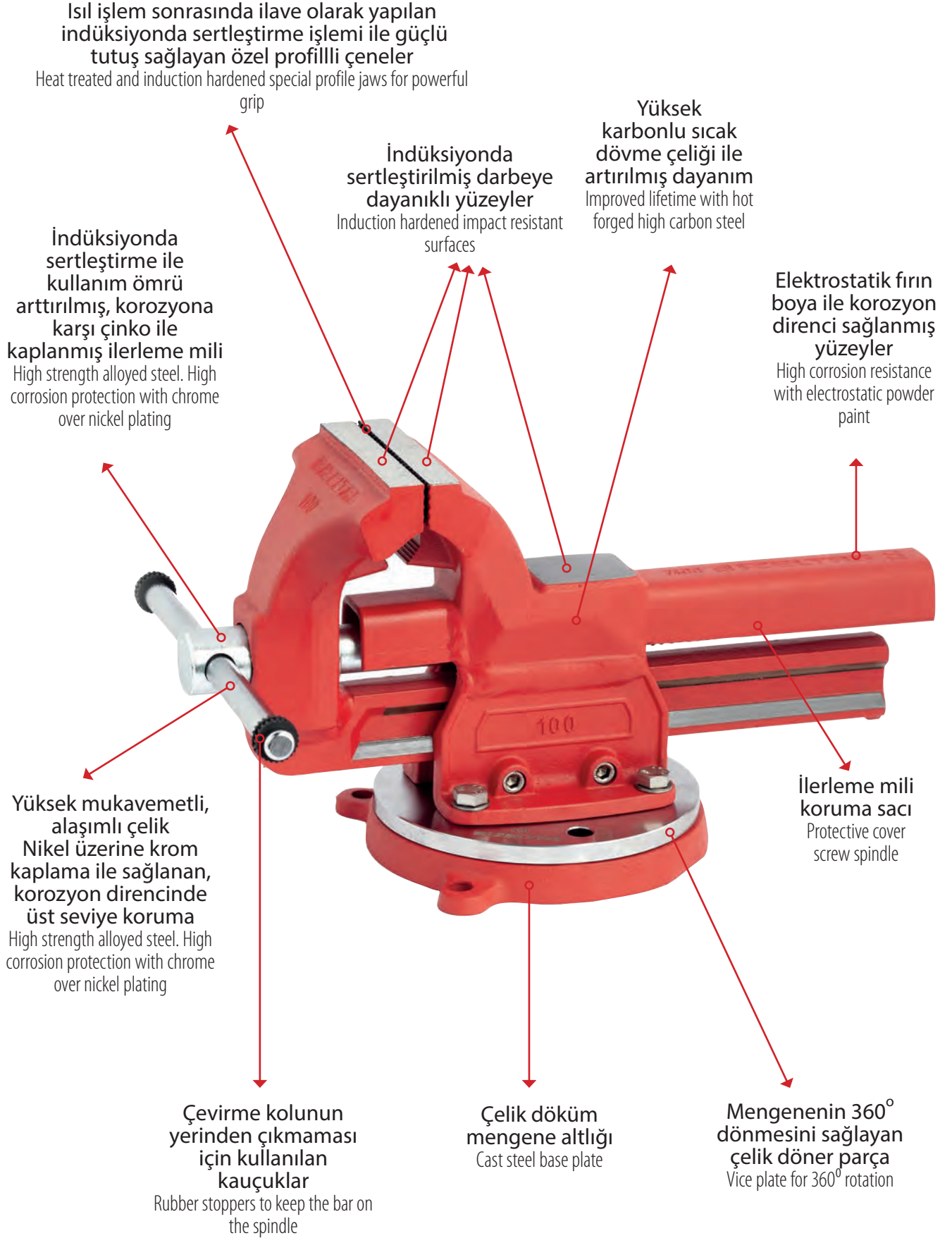

**DÖVME ÇELİK MENGENE/TFORGED STEEL VICE WITH SWIVEL BASE**

## 7401

### Mengene Döner Tablası Swivel Base of Vice

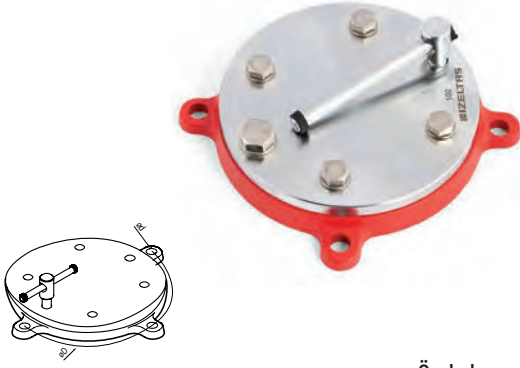

Özel alaşım çelik, Krom kaplı  
Special steel, Chrom plated

KOD CODE	ÖLÇÜ SIZE	ød mm	øD mm	g	TL/Ad.
7401 30 0100	100	10.5	160	1550	1 677,00
7401 30 0125	125	12.5	200	2700	1 894,50
7401 30 0150	150	12.5	240	3800	1 1.085,75
7401 30 0175	175	12.5	280	6650	1 1.227,50

## 7400

### Dövme Çelik Mengene Forged Steel Vice

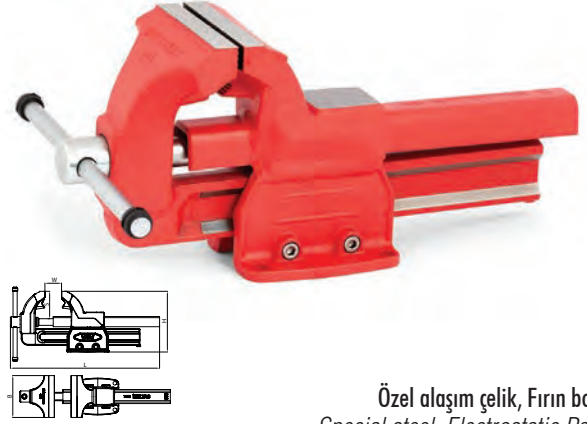

Özel alaşım çelik, Fırın boya  
Special steel, Electrostatic Paint

KOD CODE	B mm	W mm	H mm	L mm	g	TL/Ad.
7400 30 0100	100	125	148	440	5000	1 2.299,00
7400 30 0125	125	155	183	550	11000	1 3.165,25
7400 30 0150	150	180	220	675	20000	1 4.048,00
7400 30 0175	175	205	245	760	29000	1 4.980,50

## 7400

### Dövme Çelik Mengene (Döner Tabla dahil) Forged Steel Vice with Swivel Base

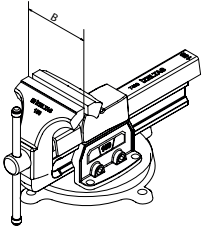

Özel alaşım çelik, Fırın boya  
Special steel, Electrostatic Paint

KOD CODE	B mm	g	TL/Ad.
7400 00 0100	100	6550	1 2.976,00
7400 00 0125	125	13700	1 4.059,75
7400 00 0150	150	23800	1 5.133,75
7400 00 0175	175	35650	1 6.208,00

**İşkence (Marangoz Mengenesi Plastik Ağızlı)**  
*Carpenter Screw Clamp*

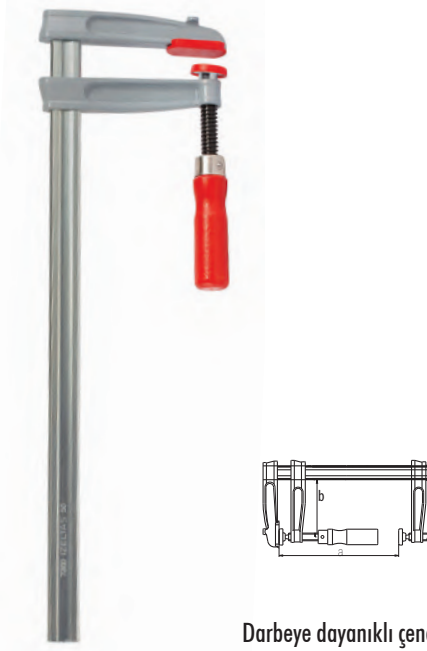

**Darbeye dayanıklı çeneler**  
*Impact resistant cast iron jaws*

KOD CODE		a mm	b mm	g		TL/Ad.
7300 30 3012	30x12	300	120	1605	5	534,50
7300 30 4012	40x12	400	120	1780	5	631,50
7300 30 5012	50x12	500	120	1935	5	647,50
7300 30 6012	60x12	600	120	2080	5	675,75
7300 30 8012	80x12	800	120	2470	5	716,75
7300 30 1012	100x12	1000	120	2790	5	818,00

**Mini İşkence**  
*Mini Clamp*



**Alaşımlı alüminyum çeneler**  
*Alloyed aluminum jaws*

KOD CODE		a mm	b mm	g		TL/Ad.
7310 30 1005	10x5	100	50	250	5	230,00
7310 30 1505	15x5	150	50	280	5	242,25
7310 30 2005	20x5	200	50	310	5	251,25
7310 30 2505	25x5	250	50	330	5	262,00
7310 30 3005	30x5	300	50	360	5	271,25



**IZELTAS®**

# MAKASLAR

SHEARS

Demir Kesme Makası  
Bolt Cutters

Saç Makasları  
Sheet Metal Cutters

Plastik Boru Kesme Makası  
Plastic Pipe Cutters

Bağ Makasları  
Prunig Shears



Isıl işlem sonrasında ilave  
indüksiyonla sertleştirme ile kullanım  
ömrü arttırılmış kesici ağızlar  
Heat-treated and induction hardened cutting edges for  
long lifetime

PVC izoleli sap  
PVC coated handle

Kolları birleştirmeye  
yarayan kilit mandalı  
Locking latch to keep the arms  
closed

Uzun ömürlü yay  
Long life spring

Mangan Fosfat Kaplı  
Yüzeyler  
Black finish

Yüksek karbonlu  
sıcak dövme  
çeliği ile arttırılmış  
dayanım  
High carbon hot forged steel  
for improved performance



İZELTAS YOUTUBE



## 2350

### Demir Kesme Makası Bolt Cutters



Yedek parça sayfa 202  
Spare parts page 202

Özel alaşımli çelik, Kesici ağızlar indüksiyonda sertleştirilmiş,  
Elektrostatik boyanmış çeneler ve bağlantı parçaları dövme  
Special steel, Cutters induction hardened,  
Electrostatically painted jaws and connection parts drop forged

KOD CODE	L mm	L inch	KAPASİTE CAPACITY Ø mm	g	TL/Ad.
2350 27 0018	450	18"	6 - 8	1510	1 873,25
2350 27 0024	600	24"	8 - 10	2350	1 1.285,25
2350 27 0030	750	30"	9 - 13	3750	1 2.012,00
2350 27 0036	900	36"	11 - 16	5500	1 2.604,00

## 2350

### Demir Kesme Makası Sehpa (Dolu) Bolt Cutters Frame



KOD CODE	İÇERİK CONTENTS	g	TL/Ad.
2350 00 6104	18"(450) - 24"(600) 30"(750) - 36"(900)	21.110	4 8.320,50

## 6205

### Alüminyum Ve Sac Kesme Makası Sağ Snip For Aluminum and Metal Sheet (Right)



Özel alaşımli çelik, Kesici ağızlar indüksiyonda sertleştirilmiş,  
Special steel, Cutters induction hardened,

KOD CODE	L mm	L inch	g	TL/Ad.
6205 27 0240	240	10"	380	5 345,25

## 6206

### Alüminyum Ve Sac Kesme Makası Sol Snip For Aluminum and Metal Sheet (Left)



Özel alaşımli çelik, Kesici ağızlar indüksiyonda sertleştirilmiş  
Special steel, Cutters induction hardened

KOD CODE	L mm	L inch	g	TL/Ad.
6206 27 0240	240	10"	380	5 345,25

## 6207

### Alüminyum Ve Sac Kesme Makası Düz Snip For Aluminum and Metal Sheet (Flat)



Özel alaşımli çelik, Kesici ağızlar indüksiyonda sertleştirilmiş  
Special steel, Cutters induction hardened

KOD CODE	L mm	L inch	g	TL/Ad.
6207 27 0240	240	10"	380	5 345,25

## 13000 001851

### Alüminyum Ve Sac Kesme Makas Takımı ( 3 Parça ) Aluminum and Metal Sheet Set ( 3 Pcs )

**YENİ  
NEW**



KOD CODE	L mm	L inch	g	TL/Ad.
13000 001851	240	10"	380	5 1.035,75

**6210****Kaportacı Makası (Sağ)**  
*Punch Snip (Right)*

DIN 6438



Özel alaşımli çelik, Kesici ağızlar indüksiyonda sertleştirilmiş, PVC izoleli  
*Special steel, Cutters induction hardened, PVC insulated*

KOD CODE	L mm	L inch	g	TL/Ad.
6210 27 0250	250	10"	555	5 434,00
6210 27 0275	275	11"	600	5 474,75
6210 27 0300	300	12"	640	5 541,25

**6211****Kaportacı Makası (Sol)**  
*Punch Snip (Left)*

DIN 6438



Özel alaşımli çelik, Kesici ağızlar indüksiyonda sertleştirilmiş, PVC izoleli  
*Special steel, Cutters induction hardened, PVC insulated*

KOD CODE	L mm	L inch	g	TL/Ad.
6211 27 0250	250	10"	535	5 434,00
6211 27 0275	275	11"	605	5 474,75
6211 27 0300	300	12"	665	5 541,25

**6820****Tenekeci Makası**  
*Tinman's Snip*

TSEK



Özel alaşımli çelik, Kesici ağızlar indüksiyonda sertleştirilmiş, PVC izoleli  
*Special steel, Cutters induction hardened, PVC insulated*

KOD CODE	L mm	L inch	g	TL/Ad.
6820 27 0200	200	8"	320	5 291,75
6820 27 0250	250	10"	575	5 372,75
6820 27 0300	300	12"	870	5 406,25

**6821****Tenekeci Makası (Yaylı)**  
*Tinman's Snip (With Spring)*

TSEK



Özel alaşımli çelik, Kesici ağızlar indüksiyonda sertleştirilmiş, PVC izoleli  
*Special steel, Cutters induction hardened, PVC insulated*

KOD CODE	L mm	L inch	g	TL/Ad.
6821 27 0250	250	10"	575	5 404,75
6821 27 0300	300	12"	895	5 442,75

**6800**

Kuyumcu Makası (Düz)  
Jeweller's Snip (Straight)

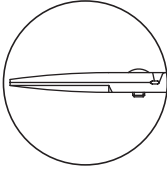

KOD CODE	L mm	L inch	g		TL/Ad.
6800 27 0180	180	7 1/8"	140	5	352,25

**6801**

Kuyumcu Makası (Eğri)  
Jeweller's Snip (Curved)

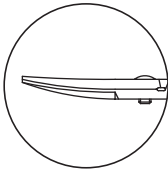

KOD CODE	L mm	L inch	g		TL/Ad.
6801 27 0180	180	7 1/8"	140	5	385,25

**6815**

Tel Kesme Makası  
Bolt Cutters



KOD CODE	L mm	L inch	g		TL/Ad.
6815 27 0200	200	8"	295	5	178,25

**13000 005122**

Dövme Tel Kesme Makası  
Forging Bolt Cutters

**YENİ  
NEW**



Özel alaşımlı çelik, Kesici ağızlar indüksiyonda sertleştirilmiş, PVC izoleli  
Special steel, Cutters induction hardened, PVC insulated

KOD CODE	L mm	L inch	g		TL/Ad.
13000 005122	210	7 1/8"	345	5	652,50

**6740**

Kombine Makas  
Multi Purpose Scissors



KOD CODE	L mm	L inch	g		TL/Ad.
6740 27 0140	140	5 1/2"	60	5	322,50
6740 27 0190	190	7 1/2"	120	5	378,25

**6710****Bağ Makası (Lüks)**  
*Pruning Shears (Lux)*

İZELTAS YOUTUBE

Özel alaşımlı çelik, Kesici ağızlar induksiyonda sertleştirilmiş, PVC izoleli  
*Special steel, Cutters induction hardened, PVC insulated*

KOD CODE	L mm	L inch	g	TL/Ad.
6710 27 0230	230	9"	290	5 311,25

**6715****Bağ Makası (Comfort)**  
*Pruning Shears (Comfort)*

Özel alaşımlı çelik, PVC izoleli  
*Special steel, PVC insulated*

KOD CODE	L mm	L inch	g	TL/Ad.
6715 27 0225	225	9"	340	5 473,75

**6720****Bağ Makası (Hafif Tip)**  
*Pruning Shears (Light)*

Alüminyum gövde, PVC izoleli  
*Aluminum forged body, PVC insulated*

KOD CODE	L mm	L inch	g	TL/Ad.
6720 27 0220	220	8 5/8"	265	5 549,50

**6712****Elma Makası**  
*Pruning Shears (Fruit)*

Özel alaşımlı çelik, Kesici ağızlar induksiyonda sertleştirilmiş, PVC izoleli  
*Special steel, Cutters induction hardened, PVC insulated*

KOD CODE	L mm	L inch	g	TL/Ad.
6712 27 0210	210	8 1/4"	365	5 550,50

**06760**

Plastik Boru Kesme Makası  
Plastic Pipe Cutter



 Yedek parça sayfa 204  
Spare parts page 204

KOD CODE	Ø mm	g	TL/Ad.
06760 50 042	42	400	5 1.189,75
06760 50 063	63	610	5 2.087,25

**6860**

Teleskopik Boru Kesici (Bakır ve Alüminyum İçin)  
Telescopic Tube Cutter (For Copper and Aluminum)



 Yedek parça sayfa 204  
Spare parts page 204

KOD CODE	ÖLÇÜ SIZE	g	TL/Ad.
6860 28 0635	1/8" - 1 3/8"	470	1 754,75

**6850**

Mini Boru Kesici (Bakır ve Alüminyum İçin)  
Mini Tube Cutter (For Copper and Aluminum)



 Yedek parça sayfa 204  
Spare parts page 204

KOD CODE	ÖLÇÜ SIZE	g	TL/Ad.
6850 28 0322	1/8" - 5/8"	120	1 256,50

**6865**

Profesyonel Boru Kesici (Çelik İçin)  
Professional Tube Cutter (For Steel)



 Yedek parça sayfa 204  
Spare parts page 204

KOD CODE	ÖLÇÜ SIZE	g	TL/Ad.
6865 28 1050	1/8" - 2"	2380	1 1.904,75

**6855**

Standart Boru Kesici (Bakır ve Alüminyum İçin)  
Standard Tube Cutter (For Copper and Aluminum)



 Yedek parça sayfa 204  
Spare parts page 204

KOD CODE	ÖLÇÜ SIZE	g	TL/Ad.
6855 28 0330	1/8" - 1 1/8"	305	1 355,00





**IZELTAS®**

# ÇEKTİRMELER

PULLERS

Çektirmeler  
Pullers

İç Rulman Çektirmeler  
Inside Pullers

Rotil Çektirmeler  
Balljoint Pullers

Saplama Sökmeler  
Stud Inserters and Removers



PULLERS

ÇEKTİRMELER

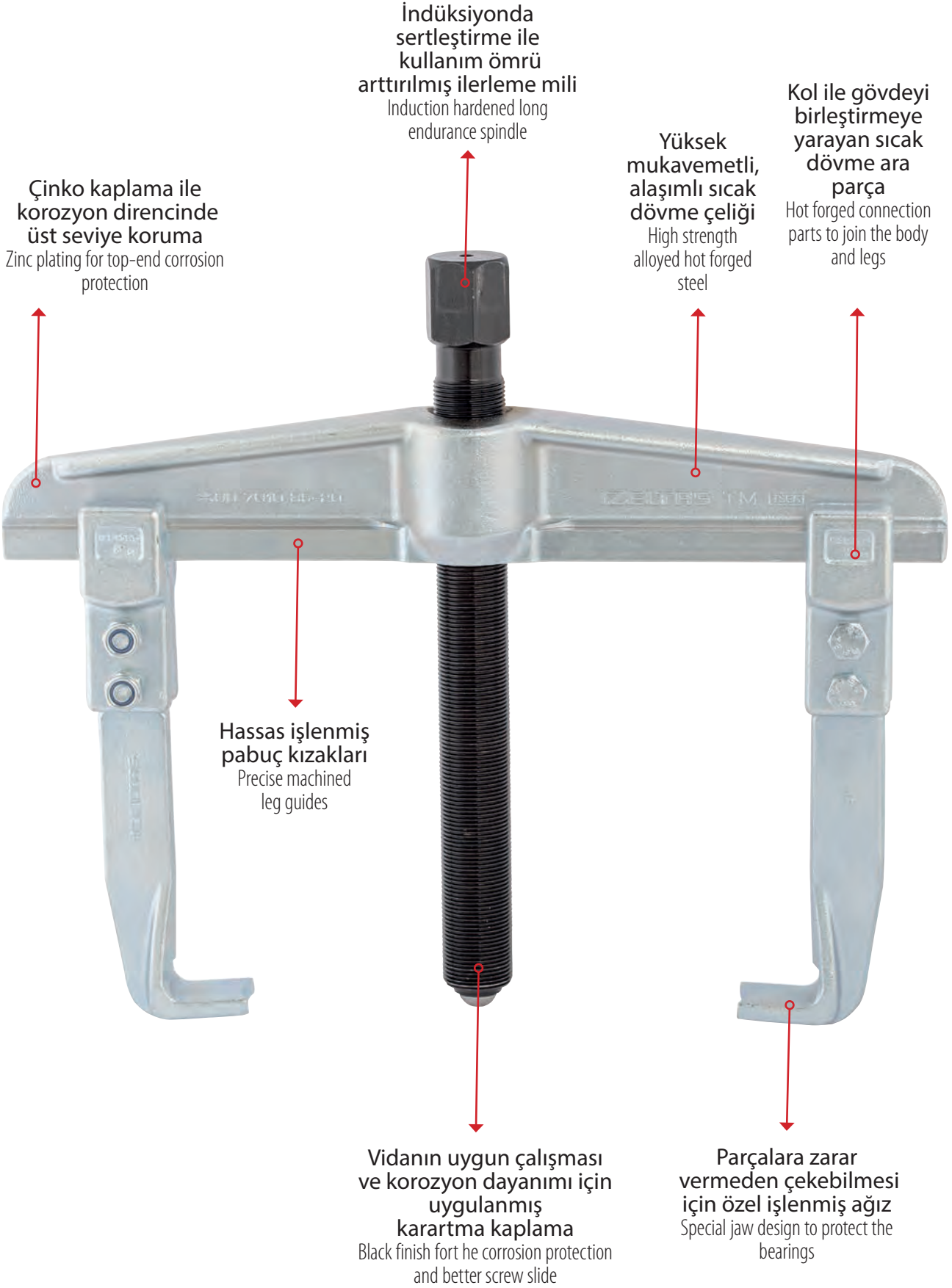
**STANDART ÇEKTİRME İKİ KOLLU / STANDARD PULLER TWO ARMS**



## 7010

### Standart Çektirme (İki Kollu) Standard Puller (Two Arms)

TSEK

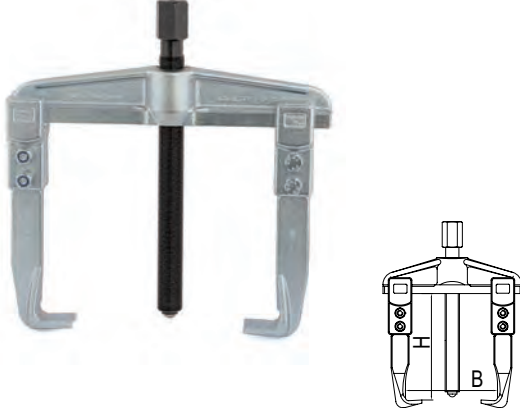

Yedek parça sayfa 205  
Spare parts page 205

Krom vanadyum, Çinko kaplı, Kollar sertleştirilmiş,  
Mil indüksiyonda sertleştirilmiş  
Chrom vanadium, Zinc plated,  
Arms hardened, Spindle induction hardened

KOD CODE		B mm	H mm	g	TL/Ad.
7010 29 0810	8x10	80	100	1080	1 873,50
7010 29 1210	12x10	120	100	1235	1 934,25
7010 29 1615	16x15	160	150	2850	1 1.592,25
7010 29 2015	20x15	200	150	3060	1 1.741,75
7010 29 2520	25x20	250	200	7450	1 3.008,25
7010 29 3520	35x20	350	200	10000	1 3.653,75
7010 29 5220	52x20	520	200	14100	1 5.370,75

## 7010

### Standart Çektirme Sehpası (Dolu) Display Frame For Pullers



KOD CODE	İÇERİK CONTENTS	g	TL/Ad.
7010 00 6105	8x10 - 12x10 - 16x15 20x15 - 25x20	17840	5 8.474,75

## 7020

### Standart Çektirme (Üç Kollu) Standart Puller (Three Arms)

TSEK



Yedek parça sayfa 205  
Spare parts page 205

Krom vanadyum, Çinko kaplı, Kollar sertleştirilmiş,  
Mil indüksiyonda sertleştirilmiş  
Chrom vanadium, Zinc plated,  
Arms hardened, Spindle induction hardened

KOD CODE		B mm	H mm	g	TL/Ad.
7020 29 3720	37x20	370	200	14750	1 6.742,25
7020 29 5220	52x20	520	200	20000	1 9.294,50

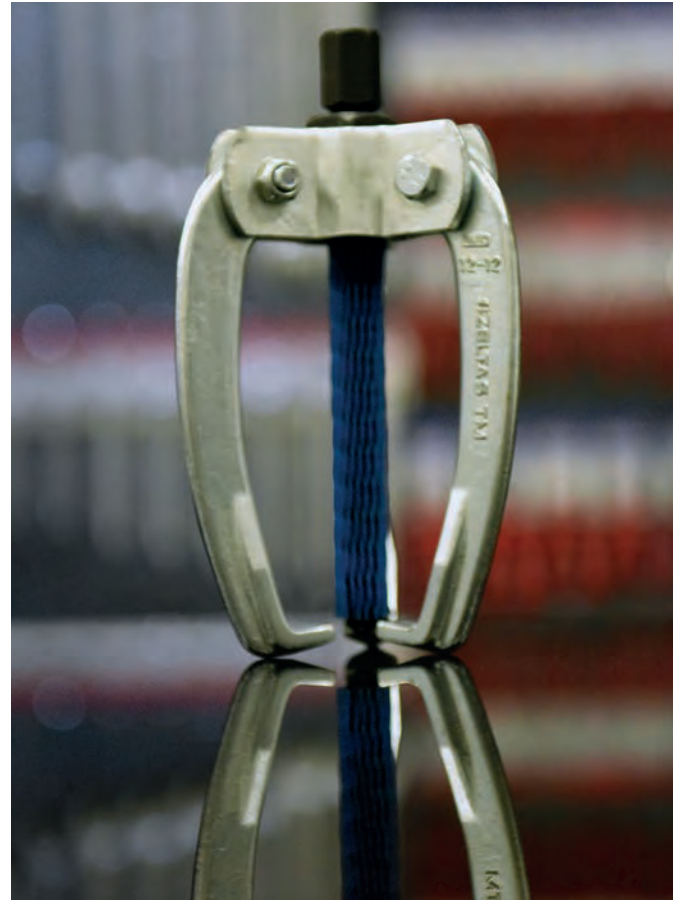

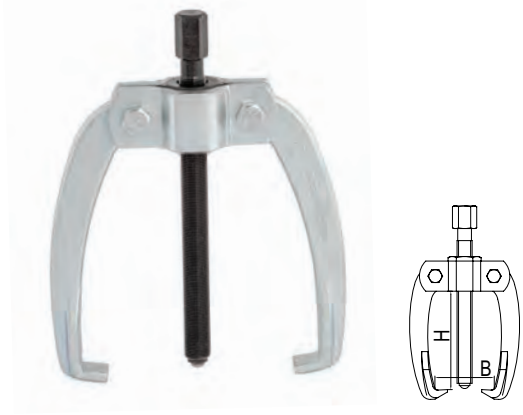
**7030**
**Master Çektirme (İki Kollu)**  
*Master Puller (Two Arms)*
**TSEK**

**Yedek parça sayfa 205**  
*Spare parts page 205*
**Krom vanadyum, Çinko kaplı, Kollar sertleştirilmiş,  
 Mil indüksiyonda sertleştirilmiş**  
*Chrom vanadium, Zinc plated,  
 Arms hardened, Spindle induction hardened*

KOD CODE		B mm	H mm	g	TL/Ad.
7030 29 0808	8x8	80	80	545	1 351,75
7030 29 1212	12x12	120	120	1075	1 725,50
7030 29 1616	16x16	160	160	1885	1 1.091,75
7030 29 2320	23x20	230	200	3240	1 1.484,25

**7040**
**Master Çektirme (Üç Kollu)**  
*Master Puller (Three Arms)*
**TSEK**

**Yedek parça sayfa 205**  
*Spare parts page 205*
**Krom vanadyum, Çinko kaplı, Kollar sertleştirilmiş,  
 Mil indüksiyonda sertleştirilmiş**  
*Chrom vanadium, Zinc plated,  
 Arms hardened, Spindle induction hardened*

KOD CODE		B mm	H mm	g	TL/Ad.
7040 29 0808	8x8	80	80	680	1 674,00
7040 29 1212	12x12	120	120	1355	1 986,25
7040 29 1616	16x16	160	160	2320	1 1.450,25
7040 29 2320	23x20	230	200	4025	1 1.952,75

**7050**
**Batarya Çektirme (İki Kollu)**  
*Battery Puller (Two Arms)*
**TSEK**

**Yedek parça sayfa 205**  
*Spare parts page 205*
**Krom vanadyum, Çinko kaplı, Kollar sertleştirilmiş,  
 Mil indüksiyonda sertleştirilmiş**  
*Chrom vanadium, Zinc plated,  
 Arms hardened, Spindle induction hardened*

KOD CODE		B mm	H mm	g	TL/Ad.
7050 29 0604	6x4	60	40	245	1 391,50
7050 29 0606	6x6	60	60	275	1 403,75
7050 29 0808	8x8	80	80	555	1 424,00

**7060**
**Batarya Çektirme (Üç Kollu)**  
*Battery Puller (Three Arms)*
**TSEK**

**Yedek parça sayfa 205**  
*Spare parts page 205*
**Krom vanadyum, Çinko kaplı, Kollar sertleştirilmiş,  
 Mil indüksiyonda sertleştirilmiş**  
*Chrom vanadium, Zinc plated,  
 Arms hardened, Spindle induction hardened*

KOD CODE		B mm	H mm	g	TL/Ad.
7060 29 0604	6x4	60	40	300	1 508,25
7060 29 0606	6x6	60	60	345	1 640,75
7060 29 0808	8x8	80	80	715	1 743,25

## 7070

S Tipi Çektirme (İki Kollu)  
S Type Puller (Two Arms)

TSEK

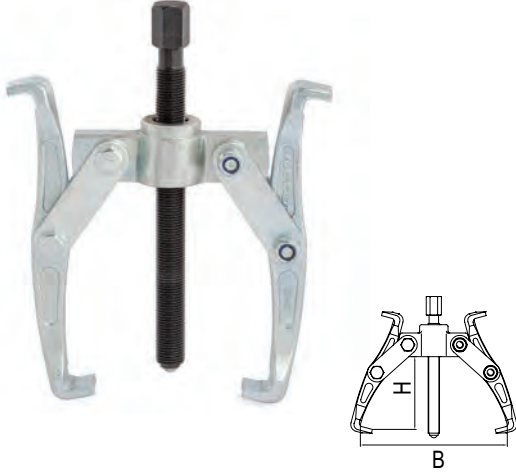

Yedek parça sayfa 205  
Spare parts page 205

Krom vanadyum, Çinko kaplı, Kollar sertleştirilmiş,  
Mil indüksiyonda sertleştirilmiş  
Chrom vanadium, Zinc plated,  
Arms hardened, Spindle induction hardened

KOD CODE		B mm	H mm	g		TL/Ad.
7070 29 2013	20x13	200	130	2420	1	964,00

## 7090

Üniversal Çektirme (İki Kollu)  
Universal Puller (Two Arms)

TSEK

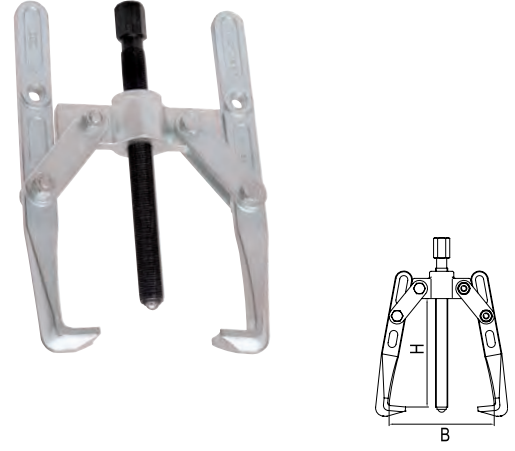

Yedek parça sayfa 205  
Spare parts page 205

Krom vanadyum, Çinko kaplı, Kollar sertleştirilmiş,  
Mil indüksiyonda sertleştirilmiş  
Chrom vanadium, Zinc plated,  
Arms hardened, Spindle induction hardened

KOD CODE		B mm	H mm	g		TL/Ad.
7090 29 2222	22x22	220	220	3085	1	1.071,25

## 7080

S Tipi Çektirme (Üç Kollu)  
S Type Puller (Three Arms)

TSEK

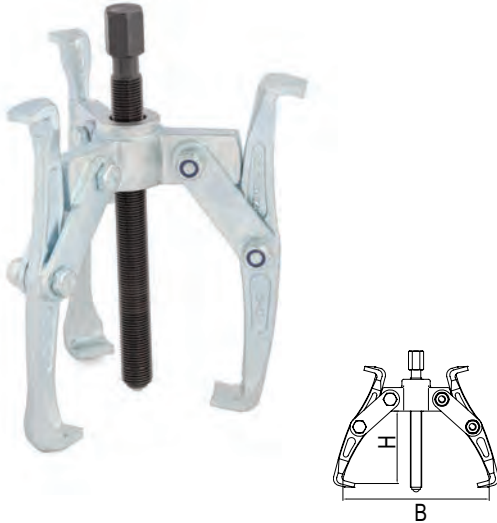

Yedek parça sayfa 205  
Spare parts page 205

Krom vanadyum, Çinko kaplı, Kollar sertleştirilmiş,  
Mil indüksiyonda sertleştirilmiş  
Chrom vanadium, Zinc plated,  
Arms hardened, Spindle induction hardened

KOD CODE		B mm	H mm	g		TL/Ad.
7080 29 2013	20x13	200	130	3250	1	1.243,25

## 7100

Üniversal Çektirme (Üç Kollu)  
Universal Puller (Three Arms)

TSEK



Yedek parça sayfa 205  
Spare parts page 205

Krom vanadyum, Çinko kaplı, Kollar sertleştirilmiş,  
Mil indüksiyonda sertleştirilmiş  
Chrom vanadium, Zinc plated,  
Arms hardened, Spindle induction hardened

KOD CODE		B mm	H mm	g		TL/Ad.
7100 29 2222	22x22	220	220	4125	1	1.404,25

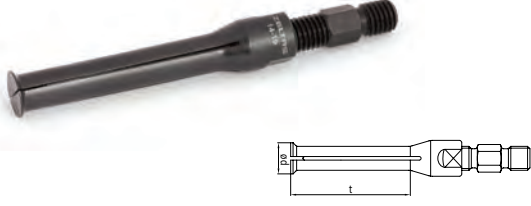
**İç Rulman Çektirme Pensleri - Model A**  
*Internal Expansion Puller - Model A*

KOD CODE	øD mm	t mm	Kullanılan Kol / For	Adaptör vidası	g	TL/Ad.
7120 29 0507	5 - 7	30	35 - 75	M10	40	803,25
7120 29 0709	7 - 9	30	35 - 75	M10	40	803,25
7120 29 0912	9 - 12	30	35 - 75	M10	40	744,25
7120 29 1013	10 - 13	30	35 - 75	M10	40	744,25
7120 29 1317	13 - 17	50	35 - 75	M10	60	744,25
7120 29 1419	14 - 19	60	35 - 75	M10	75	762,50
7120 29 1621	16 - 21	60	35 - 75	M10	75	762,50
7120 29 1823	18 - 23	60	35 - 75	M10	100	912,75
7120 29 2025	20 - 25	60	35 - 75	M10	100	963,50
7120 29 2530	25 - 30	60	35 - 75	M10	110	1.003,75
7120 29 3037	30 - 37	70	35 - 75 60 - 130	M10	250	1.162,75
7120 29 3542	35 - 42	70	35 - 75 60 - 130	M10	250	1.222,00
7120 29 3845	38 - 45	70	35 - 75 60 - 130	M10	250	1.288,25
7120 29 4350	43 - 50	70	35 - 75 60 - 130	M10	400	1.464,75

**İç Rulman Çektirme Pensleri - Model B**  
*Internal Expansion Puller - Model B*

KOD CODE	øD mm	t mm	Kullanılan Kol / For	Adaptör vidası	g	TL/Ad.
7120 29 2540	25 - 40	45	35 - 75 60 - 130	M10	235	1.626,50

**İç Rulman Çektirme Kolları**  
*Arms For Internal Expansion Puller*

Krom vanadyum, Çinko kaplı, Kollar sertleştirilmiş,  
Mil indüksiyonda sertleştirilmiş  
Chrom vanadium, Zinc plated,  
Arms hardened, Spindle induction hardened

KOD CODE	Kapasite Capacity mm	Kullanılan pensler / For	Adaptör vidası Screw Adapter	g	TL/Ad.
----------	----------------------	--------------------------	------------------------------	---	--------

7120 29 3575	35 - 75	Model A 5 - 7'den 43 - 50'ye Model B 25 - 40	M10	625	1 818,25
--------------	---------	--	-----	-----	----------

7120 29 6013	60 - 130	Model A 30 - 37'den 43 - 50'ye Model B 25 - 40	M10	1000	1 1.658,00
--------------	----------	--	-----	------	------------



## 7122

### Dış Rulman Çektirme Çeneleri Seperator



Krom vanadyum, Çinko kaplı, Kollar sertleştirilmiş,  
Mil indüksiyonda sertleştirilmiş  
Chrom vanadium, Zinc plated,  
Arms hardened, Spindle induction hardened

KOD CODE	Ø mm	Kullanılan Kollar / For	Adaptör vidası	g	TL/Ad.
7122 29 0560	5 - 60	40 - 115	M12	370	1 1.242,00
7122 29 1275	12 - 75	40 - 115	M12	635	1 1.556,00
7122 29 2211	22 - 115	55 - 205	M16	1780	1 2.429,50
7122 29 2515	25 - 155	90 - 260	M20x1.5	3940	1 3.803,25
7122 29 3022	30 - 220	100 - 360	M20x1.5	11000	1 10.393,50
7122 29 4028	40 - 280	140 - 435	M24x3	15000	1 23.213,75

## 7122

### Dış Rulman Çektirme Kolları Puller Arms For Separator

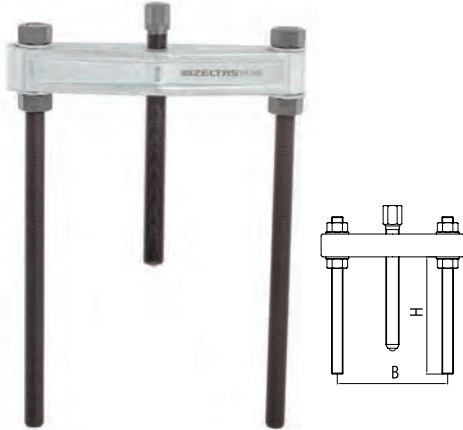

Krom vanadyum, Çinko kaplı, Kollar sertleştirilmiş,  
Mil indüksiyonda sertleştirilmiş  
Chrom vanadium, Zinc plated,  
Arms hardened, Spindle induction hardened

KOD CODE	B mm	H mm	Kullanılan Çene / For	Adaptör vidası	g	TL/Ad.
7122 29 4011	40-115	150	5 - 60 12 - 75	M12	990	1 2.314,75
7122 29 5520	55-205	210	22 - 115	M16	2700	1 3.664,00
7122 29 9026	90-260	315	25 - 155	M20x1.5	4965	1 5.187,50
7122 29 1036	100-360	305	30 - 220	M20x1.5	7000	1 10.675,50
7122 29 1443	140-435	320	40 - 280	M24x3	11000	1 20.865,50

## 7126

### Rotil Çektirme Extractor For Ball Joint

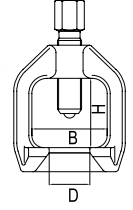

KOD CODE	ØD mm	B mm	H mm	g	TL/Ad.
7126 29 0018	18	40	40	315	1 696,50
7126 29 0025	25	50	50	540	1 954,75
7126 29 0029	29	60	60	915	1 1.270,00
7126 29 0040	40	80	80	1965	1 1.792,75
7126 29 0045	45	90	100	2670	1 2.263,50





**IZELTAS®**

**elta**

**Anahtarlar**

*Wrenches*

**Lokma Anahtarları**

*Sockets Wrenches*

**Boru Anahtarları ve Penseler**

*Pipe Wrenches and Pliers*

**Tornavida ve Allen Anahtarlar**

*Screwdrivers and Hex Key Wrenches*

**Keskiler**

*Chisels*

**Genel El Aletleri**

*General Hand Tools*

**Makaslar**

*Shears*

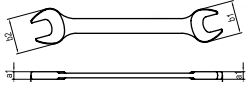

**elta**

**0150**
**İki Ağız Anahtar (mm)**
*Double Ended Open Jaw Wrench (mm)*

 Krom vanadyum, Krom kaplı  
 Chrom vanadium, Chrom plated

KOD CODE	mm	L mm	a1 mm	b1 mm	b2 mm	g	TL/Ad.
0150 01 0607	6x7	98	3.3	13.5	15.5	10	26,50
0150 01 0809	8x9	108	3.6	17.5	19.5	20	27,00
0150 01 1011	10x11	120	4.1	21.5	23.5	30	29,25
0150 01 1213	12x13	134	4.5	25.5	27.5	40	32,25
0150 01 1415	14x15	150	5	29.5	31.5	60	37,50
0150 01 1617	16x17	163	5.5	33.5	35.5	85	43,25
0150 01 1819	18x19	178	6	37.5	39.5	110	46,50
0150 01 2022	20x22	198	6.5	41.5	45.5	145	52,75
0150 01 2123	21x23	218	6.9	43.5	47.5	175	57,50
0150 01 2426	24x26	236	7.4	49.5	53.5	235	66,00
0150 01 2528	25x28	250	7.8	51.5	57.5	275	79,25
0150 01 2732	27x32	265	8.3	55.5	65.5	345	94,50

**0150**
**İki Ağız Anahtar Takımı (mm)**
*Double Ended Open Jaw Wrench Set (mm)*



KOD CODE	İÇERİK CONTENTS	g	TL/Ad.
0150 00 2108	6x7 - 8x9 - 10x11 12x13 - 14x15 - 16x17 18x19 - 20x22	560	8 295,00
0150 00 2112	6x7 - 8x9 - 10x11 12x13 - 14x15 - 16x17 18x19 - 20x22 - 21x23 24x26 - 25x28 - 27x32	1590	12 592,25

 (★) İşaretili olan ürünler stoklarla sınırlıdır.  
 Limited with stocks.



**Kombine Anahtar (mm)**  
*Combination Wrench (mm)*

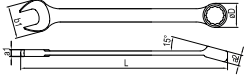

TS 3794  
TS ISO 7738 Form A  
DIN 3113



Krom vanadyum, Krom kaplı  
*Chrom vanadium, Chrom plated*

**0350**
**Kombine Anahtar Takımı (mm)**  
*Combination Wrench Set (mm)*

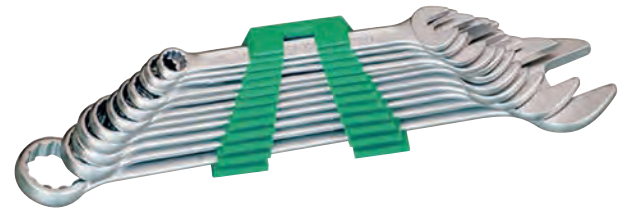
KOD CODE	mm	L mm	a1 mm	a2 mm	b1 mm	øD mm	g	TL/ Ad.	
0350 02 0006	6	95	3.1	5.1	13.5	10	15	10	34,50
0350 02 0007	7	104	3.3	5.5	15.5	11.5	15	10	36,75
0350 02 0008	8	112	3.7	5.9	17.5	13	20	10	39,75
0350 02 0009	9	121	3.9	6.3	19.5	14	25	10	41,00
0350 02 0010	10	130	4.3	6.9	21.5	15.5	30	10	46,25
0350 02 0011	11	138	4.5	7.3	23.5	16.5	35	10	47,75
0350 02 0012	12	146	4.9	7.7	25.5	18	45	10	50,75
0350 02 0013	13	154	5.1	8.1	27.5	19	50	10	51,50
0350 02 0014	14	163	5.5	8.7	29.5	21.5	60	10	55,75
0350 02 0015	15	171	5.7	9.1	31.5	22	70	10	59,50
0350 02 0016	16	180	6.1	9.5	33.5	23	85	10	64,00
0350 02 0017	17	189	6.3	9.9	35.5	25	95	10	68,50
0350 02 0018	18	200	6.7	10.4	37.5	26.5	110	10	76,00
0350 02 0019	19	211	6.9	11	39.5	28	130	10	80,00
0350 02 0020	20	222	7.3	11.4	41.5	29.5	145	10	81,50
0350 02 0021	21	235	7.3	11.4	43.5	31	160	10	94,75
0350 02 0022	22	250	8.1	12.6	45.5	32.5	200	10	108,25
0350 02 0024	24	270	8.7	13.6	49.5	36	250	5	132,25
0350 02 0027	27	300	9.6	14.8	55.5	40	350	5	155,75
0350 02 0030	30	330	10.2	15.8	61.5	44.5	445	5	178,75
0350 02 0032	32	350	10.4	16.2	65.5	47	500	5	187,25



KOD CODE	İÇERİK CONTENTS	g	TL/ Ad.	
0350 00 2108	6 - 7 - 8 - 9 - 10 - 13 17 - 19	395	8	398,25
0350 00 2112	8 - 9 - 10 - 11 - 12 13 - 14 - 15 - 16 17 - 19 - 22	855	12	713,00
0350 00 2117	6 - 7 - 8 - 9 - 10 11 - 12 - 13 - 14 15 - 16 - 17 - 18 19 - 20 - 21 - 22	1300	17	1.036,50
0350 00 2121	6 - 7 - 8 - 9 - 10 11 - 12 - 13 - 14 15 - 16 - 17 - 18 19 - 20 - 21 - 22 24 - 27 - 30 - 32	2810	21	1.690,50

(★) İşaretili olan ürünler stoklarla sınırlıdır.  
*Limited with stocks.*

## 0450

### Yıldız İki Ağız Anahtar (mm) Double Ended Ring Wrench (mm)



TS 3794  
TS ISO 10104 Form B  
DIN 838

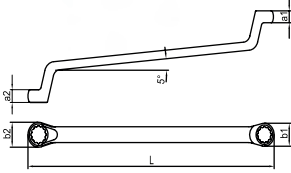

Krom vanadyum, Krom kaplı  
Chrom vanadium, Chrom plated

KOD CODE	mm	L mm	a1 mm	a2 mm	b1 mm	b2 mm	g		TL/Ad.
0450 03 0607	6x7	140	4.8	5.2	11	12	45	10	59,50
0450 03 0809	8x9	158	5.4	5.8	13.5	14.5	60	10	60,25
0450 03 1011	10x11	175	6	6.4	16	17.5	90	10	67,00
0450 03 1213	12x13	193	6.6	7.1	19	20	100	10	75,50
0450 03 1415	14x15	210	7.7	8.1	21.5	23.5	140	10	79,25
0450 03 1617	16x17	230	9.2	9.6	25.5	26.5	190	10	89,75
0450 03 1819	18x19	246	10.2	10.6	27.5	29.5	240	10	107,25
0450 03 2022	20x22	280	11.2	11.8	31	34	255	5	117,25
0450 03 2123	21x23	284	11.4	12.2	32.5	35	300	5	134,50
0450 03 2426	24x26	300	12.6	13.2	37	39	335	5	156,50
0450 03 2528	25x28	314	13.6	14.2	38	42	430	5	171,50
0450 03 2732	27x32	329	14.8	15.2	41	49	525	5	189,00

## 0450

### Yıldız İki Ağız Anahtar Takımı (mm) Double Ended Ring Wrench Set (mm)

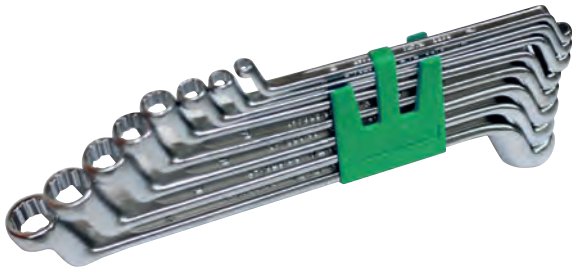

KOD CODE	İÇERİK CONTENTS	g		TL/Ad.
0450 00 2108	6x7 - 8x9 - 10x11 12x13 - 14x15 - 16x17 18x19 - 20x22	1120	8	655,75
0450 00 2112	6x7 - 8x9 - 10x11 12x13 - 14x15 - 16x17 18x19 - 20x22 - 21x23 24x26 - 25x28 - 27x32	2710	12	1.307,25

## 0601

### Kurbağacak Anahtar Adjustable Wrench

TS 3796  
DIN 3117

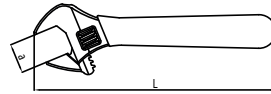

Krom vanadyum, Krom kaplı, PVC izoleli  
Chrom vanadium, Chrom plated, PVC Insulated

KOD CODE	L mm	L inch	a mm	g		TL/Ad.
0601 01 0008	206	8"	23	240	5	205,25
0601 01 0010	256	10"	28	400	5	309,00
0601 01 0012	306	12"	34	650	5	408,25

(★) İşaretili olan ürünler stoklarla sınırlıdır.  
Limited with stocks.

## 1115

1/2" Altı Köşe Lokma Anahtar (mm)  
Socket Wrench 6 Points (mm)

TS ISO 2725  
DIN 3124



1/2"

Krom vanadyum, Krom kaplı  
Chrom vanadium, Chrom plated

KOD CODE	mm	Ø D1 mm	Ø D2 mm	L mm	L1 mm	g	TL/Ad.	
1115 06 0010	10	15.4	22	38	8	60	10	43,75
1115 06 0011	11	16.6	22	38	8	60	10	43,75
1115 06 0012	12	17.9	22	38	9	60	10	43,75
1115 06 0013	13	19	22	38	10	60	10	45,50
1115 06 0014	14	20.4	22	38	11	60	10	45,50
1115 06 0015	15	21.6	22	38	11	65	10	45,50
1115 06 0016	16	22.9	22	38	11	70	10	47,25
1115 06 0017	17	24.1	22	38	12	70	10	47,25
1115 06 0018	18	25.4	23	38	13	75	10	47,25
1115 06 0019	19	26.6	23	38	13	75	10	50,75
1115 06 0020	20	28	24	38	13	80	10	50,75
1115 06 0021	21	29.2	24	38	13	80	5	50,75
1115 06 0022	22	30.4	26	38	15	95	5	50,75
1115 06 0023	23	31.2	28	38	15	100	5	55,25
1115 06 0024	24	33	28	38	17	115	5	55,25
1115 06 0026	26	34	30	42	17	130	5	62,00
1115 06 0027	27	36.6	30	42	19	140	5	70,50
1115 06 0028	28	37.5	30	42	20	160	5	74,25
1115 06 0030	30	40	32	44	21	175	5	74,25
1115 06 0032	32	43	34	44	23	180	5	79,50

## 1514

1/2" T Kol Adaptörü  
Adapter



1/2"

Krom vanadyum, Krom kaplı  
Chrom vanadium, Chrom plated

KOD CODE	inch	g	TL/Ad.	
1514 06 6250	3/8"Fx1/2"M	90	5	96,25

## 1514

1/2" Ara Kol  
Extension Bar

TS ISO 3316  
DIN 3123



1/2"

Krom vanadyum, Krom kaplı  
Chrom vanadium, Chrom plated

KOD CODE	L mm	g	TL/Ad.	
1514 06 4125	125	220	5	88,00
1514 06 4250	250	425	5	152,50

## 1514

1/2" T Kol  
Sliding T - Handle

TS ISO 3315  
DIN 3122



1/2"

Krom vanadyum, Krom kaplı  
Chrom vanadium, Chrom plated

KOD CODE	L mm	g	TL/Ad.	
1514 06 4025	250	370	5	167,75

## 1514

1/2" Mafsal  
Universal Joint

TS ISO 3316  
DIN 3123



1/2"

Krom vanadyum, Krom kaplı  
Chrom vanadium, Chrom plated

KOD CODE	L mm	g	TL/Ad.	
1514 06 4065	65	140	5	117,00

Havali aletler ile kullanmayınız / Do not use with power-tools

**1514**

1/2" Cırcır Kolu  
Ratchet Handle

TS ISO 3315  
DIN 3122



**1/2"**

Krom vanadyum, Krom kaplı  
Chrom vanadium, Chrom plated

KOD CODE	L mm	g	TL/Ad.
1514 06 5250	250	585	357,50

**1115**

1/2" Altı Köşe Lokma Anahtar Takımı (17 Parça, mm)  
Socket Wrench Set 6 Points (17 pcs, mm)

**1115**

1/2" Altı Köşe Lokma Anahtar Takımı (24 Parça, mm)  
Socket Wrench Set 6 Points (24 pcs, mm)



**1/2"**

KOD CODE	LOKMALAR Sockets	AVADANLIKLAR Accessories	g	TL/Ad.
1115 00 2017	10 - 11 - 12 13 - 14 - 15 17 - 19 - 22 24 - 27 - 30 32	1/2" Cırcır Kolu Ratchet Handle 1/2" T Kol Adaptör Sliding T Handle Adapter 1/2" Mafsal Universal Joint 1/2" Ara Kol Extension Bar 250 mm	2650	17 1.419,25

**1/2"**

KOD CODE	LOKMALAR Sockets	AVADANLIKLAR Accessories	g	TL/Ad.
1115 00 2024	10 - 11 - 12 13 - 14 - 15 16 - 17 - 18 19 - 21 - 22 23 - 24 - 26 27 - 28 - 30 - 32	1/2" Cırcır Kolu Ratchet Handle 1/2" Mafsal Universal Joint 1/2" T Kol Adaptör Sliding T Handle Adapter 1/2" Ara Kol Extension Bar 125 mm 1/2" Ara Kol Extension Bar 250 mm	3485	24 1.844,00

Havali aletler ile kullanmayınız / Do not use with power-tools

(★) İşaretili olan ürünler stoklarla sınırlıdır.  
Limited with stocks.

2203

Maşalı Boru Anahtarı (85°)  
Pipe Wrench (85°)

DIN 5234

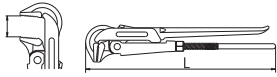

Krom vanadyum, Dişler induksiyonda sertleştirilmiş, Elektrostatik boyanmış  
Chrom vanadium, Teeth induction hardened, Electrostatically painted

KOD CODE	L mm	mm	inch	g		TL/Ad.
2203 10 0010	325	40	1"	760	1	352,00
2203 10 0015	430	60	1 1/2"	1360	1	552,50
2203 10 0020	585	70	2"	2350	1	823,75

2401

Fort Pense  
Waterpump Pliers

TS 60  
TS ISO 8976  
DIN 8976

2509

Ayarlı Pense  
Grip

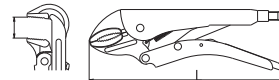
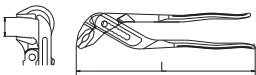

Krom vanadyum, Nikel kaplı, PVC izoleli  
Chrom vanadium, Nickel plated, PVC Insulated

Çeneler krom vanadyum çeliğinden dövülmüştür, Nikel kaplama,  
Kullanım sahası: Yuvarlak ve düz malzemeler  
Jaws Chrom vanadium forged, Nickel plated  
Applicatation field : Flat and round materials

KOD CODE	L mm	L inch	mm	g		TL/Ad.
2401 11 0240	240	9 1/2"	35	375	5	332,50

KOD CODE	L mm	L inch	mm	g		TL/Ad.
2509 11 0225	225	9"	30	470	5	320,50

### 3021

#### Kombine Pense Opak Seri Combination Pliers

TS 60  
DIN ISO 5746



Özel alaşımli çelik, Kesici ağızlar induksiyonda sertleştirilmiş, PVC saplı  
Special steel, Cutters induction hardened, PVC handle

KOD CODE	L mm	L inch	g	□	TL/Ad.
3021 12 1160	160	6 1/4"	200	5	171,75
3021 12 1180	180	7 1/8"	250	5	210,25
3021 12 1200	200	8"	310	5	256,25

### 3221

#### Kargaburun Düz Uçlu Opak Seri Long Nose Pliers (Flat)

TS 60  
TS ISO 5745



Özel alaşımli çelik, Kesici ağızlar induksiyonda sertleştirilmiş, PVC saplı  
Special steel, Cutters induction hardened, PVC handle

KOD CODE	L mm	L inch	g	□	TL/Ad.
3221 13 1160	160	6 1/4"	145	5	186,50
3221 13 1200	200	8"	190	5	213,50

### 3701

#### Yan Keski Opak Seri Side Cutting Pliers

TS 60  
TS ISO 5749  
DIN 5749



Özel alaşımli çelik, Kesici ağızlar induksiyonda sertleştirilmiş, PVC saplı  
Special steel, Cutters induction hardened, PVC handle

KOD CODE	L mm	L inch	g	□	TL/Ad.
3701 16 1140	140	5 1/2"	160	5	163,25
3701 16 1160	160	6 1/4"	220	5	191,75

### 3801

#### Kerpeten Carpenter Pincers

TS 60  
TS ISO 9243  
DIN ISO 9243



Özel alaşımli çelik, Kesici ağızlar induksiyonda sertleştirilmiş, Vernikli, PVC izoleli  
Special steel, Cutters induction hardened, Lacquered, PVC Insulated

KOD CODE	L mm	L inch	g	□	TL/Ad.
3801 15 0160	160	6 1/4"	235	5	187,00
3801 15 0180	180	7 1/8"	245	5	201,75
3801 15 0200	200	8"	390	5	252,25

### 3832

#### Betoncu Kerpeteni Tower Pincers

TS 60  
TS ISO 9242  
DIN ISO 9242



Özel alaşımli çelik, Kesici ağızlar induksiyonda sertleştirilmiş, Vernikli, PVC izoleli  
Special steel, Cutters induction hardened, Lacquered, PVC insulated

KOD CODE	L mm	L inch	g	□	TL/Ad.
3832 15 0225	225	9"	335	5	240,25
3832 15 0250	250	10"	415	5	274,00
3832 15 0280	280	11"	475	5	328,50

### 4170

#### Değişken Uçlu Tornavida Screwdriver - Reversible

TSEK



Krom vanadyum, Krom kaplı, PP saplı  
Chrom vanadium, Chrom plated, PP handle

KOD CODE	øDxL1 mm	axb mm	+	L mm	g	□	TL/Ad.
4170 17 0680	6x80	1.2x6	Ph2	180	60	10	70,00

(★) İşaretili olan ürünler stoklarla sınırlıdır.  
Limited with stocks.

**4150**
**Opak Seri Düz Uçlu Tornavida**  
*Screwdriver, Opak, Flat*

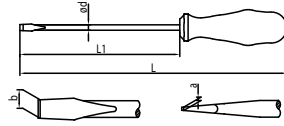
 TS ISO 2380 - 1  
 DIN ISO 2380-1

**Krom vanadyum, Krom kaplı, PP saplı**  
*Chrom vanadium, Chrom plated, PP handle*

KOD CODE	øDxL1 mm	-		L mm	g	TL/Ad.	
		a mm	b mm				
4150 17 0380	3x80	0.5	3	150	20	10	30,50
4150 17 0480	4x80	0.8	4	170	30	10	35,00
4150 17 4100	4x100	0.8	4	190	40	10	37,50
4150 17 5100	5x100	1.0	5.5	200	55	10	45,00
4150 17 5125	5x125	1.0	5.5	225	60	10	52,00
4150 17 6100	6x100	1.2	6.5	200	70	10	47,00
4150 17 6125	6x125	1.2	6.5	225	75	10	53,25
4150 17 6150	6x150	1.2	6.5	250	80	10	58,75
4150 17 7150	7x150	1.2	8	260	110	10	68,75
4150 17 8150	8x150	1.6	10	260	130	10	74,50
4150 17 8175	8x175	1.6	10	285	135	10	83,50

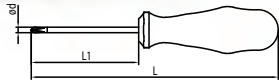
**4170**
**Opak Seri Yıldız Uçlu Tornavida**  
*Screwdriver, Opak Phillips*

 TS 59 - 5 ISO 8764  
 DIN ISO 8764

**Krom vanadyum, Krom kaplı, PP saplı**  
*Chrom vanadium, Chrom plated, PP handle*

KOD CODE	øDxL1 mm	+	L mm	g	TL/Ad.	
						4170 18 0360
4170 18 4580	4.5x80	Ph1	170	45	10	46,50
4170 18 6100	6x100	Ph2	200	70	10	55,75
4170 18 8150	8x150	Ph3	260	130	10	105,25

**4150**
**Opak Seri Tornavida Seti (6 parça)**  
*Screwdriver Set, Opak (6 Pcs)*

KOD CODE	İÇERİK CONTENTS	g	TL/Ad.
4150 00 8106	4x80 - 5x100 - 6x125	545	6
	7x150		
	<b>Düz uçlu / Flat</b> 4.5x80 - 6x100 <b>Yıldız uçlu / Phillips</b>		

**4150**
**Opak Seri Tornavida Seti (7 parça)**  
*Screwdriver Set, Opak (7 Pcs)*



KOD CODE	İÇERİK CONTENTS	g	TL/Ad.
4150 00 8107	3x80 - 4x100 - 5x125	605	7
	6x150 - 8x175		
	<b>Düz uçlu / Flat</b> 4.5x80 - 6x100 <b>Yıldız uçlu / Phillips</b>		

 (★) İşaretili olan ürünler stoklarla sınırlıdır.  
*Limited with stocks.*

## 4908

Allen Anahtar Altı Köşe (mm)  
Hex Key Wrench (mm)

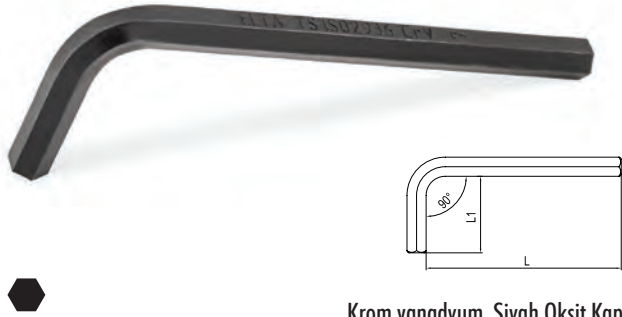
TS ISO 2936  
DIN ISO 2936



Krom vanadyum, Siyah Oksit Kaplı  
Chrom vanadium, Black finish

KOD CODE	mm	L mm	L1 mm	g	TL/Ad.	
4908 22 0015	1.5	45	14	1.5	10	4,25
4908 22 0020	2	50	16	2	10	5,25
4908 22 0025	2.5	56	18	4	10	6,25
4908 22 0030	3	63	20	6	10	7,25
4908 22 0035	3.5	66	22	8	10	8,25
4908 22 0040	4	70	25	10	10	9,50
4908 22 0050	5	80	28	20	10	10,00
4908 22 0060	6	90	32	30	10	13,75
4908 22 0070	7	95	36	40	10	19,50
4908 22 0080	8	100	36	55	10	22,50
4908 22 0090	9	105	38	75	10	31,75
4908 22 0100	10	112	40	100	10	34,25
4908 22 0120	12	125	45	160	10	50,00

## 4908

Allen Anahtar Takım Altı Köşe (mm)  
Hex Key Wrench Set (mm)

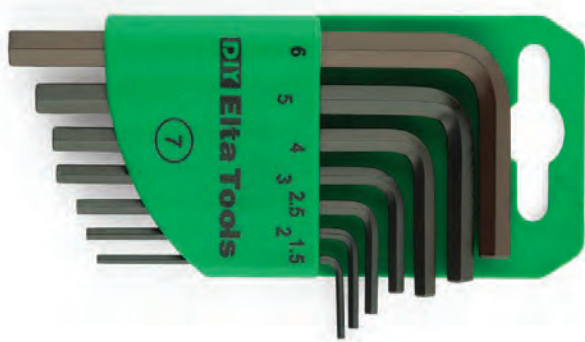

KOD CODE	İÇERİK CONTENTS	g	TL/Ad.	
4908 00 3107	1.5 - 2 - 2.5 - 3 - 4 - 5 - 6	80	7	56,25
4908 00 3109	1.5 - 2 - 2.5 - 3 - 4 - 5 - 6 - 8 - 10	235	9	113,00
4908 00 3110	1.5 - 2 - 2.5 - 3 - 4 - 5 - 6 - 8 - 10 - 12	395	10	163,00

## 4922

T Tipi Allen Anahtar (mm)  
Hex Key Wrench T - Handle (mm)



Krom vanadyum, Siyah Oksit Kaplı, PP saplı  
Chrom vanadium, Black finish, PP handle

KOD CODE	mm	L mm	L1 mm	g	TL/Ad.	
4922 22 0025	2.5	110	14	15	5	56,00
4922 22 0030	3	125	18	20	5	56,25
4922 22 0040	4	140	22	30	5	57,00
4922 22 0050	5	155	26	55	5	64,50
4922 22 0060	6	170	30	75	5	70,75
4922 22 0070	7	185	34	115	5	73,25
4922 22 0080	8	200	38	150	5	88,25
4922 22 0100	10	220	48	270	5	154,00

## 4922

T Tipi Allen Anahtar Takımı (8 Parça, mm)  
Hex Key Wrench T - Handle Set (8 Pcs, mm)



KOD CODE	İÇERİK CONTENTS	g	TL/Ad.	
4922 00 8108	2.5 - 3 - 4 - 5 6 - 7 - 8 - 10	730	8	620,00

(★) İşaretili olan ürünler stoklarla sınırlıdır.  
Limited with stocks.



**4915**

Kaset Allen Anahtar Takımı (6 Parça, mm)  
Hex Key Wrench Folding Set (6 Pcs, mm)



Krom vanadyum, Siyah oksid kaplı  
Chrom vanadium, Black finish

KOD CODE	İÇERİK CONTENTS	g	TL/Ad.
4915 00 6106	2.5 - 3 - 4 - 5 - 6 - 8	175	1 275,00

**5011**

Iskarpela (Düz)  
Wood Chisel

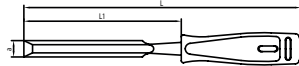

Özel alaşımlı çelik, Uç indüksiyonda sertleştirilmiş, PP Saplı  
Special steel, induction hardened tips, PP Handle

KOD CODE	a mm	L mm	L1 mm	g	TL/Ad.
5011 23 0006	6	240	120	105	5 103,75
5011 23 0008	8	242	122	125	5 110,00
5011 23 0010	10	244	124	140	5 116,25
5011 23 0012	12	246	126	140	5 127,50
5011 23 0014	14	248	128	145	5 132,00
5011 23 0016	16	250	130	165	5 141,00
5011 23 0018	18	252	132	165	5 153,00
5011 23 0020	20	254	134	165	5 169,75
5011 23 0022	22	256	136	180	5 184,50
5011 23 0024	24	258	138	205	5 198,75
5011 23 0026	26	260	140	205	5 206,25
5011 23 0030	30	264	144	205	5 220,00

**5884**

Plastik Şerit Metre  
Plastic Measuring tapes



KOD CODE	ÖLÇÜ SIZE	g	TL/Ad.
5884 26 0003	3	95	5 47,00
5884 26 0005	5	195	5 67,75

**5891**

Testere Kolu  
Hacksaw Frame

DIN 6473



KOD CODE	L mm	g	TL/Ad.
5891 26 0830	300	345	5 168,00

**6351**

Levye Oluklu  
Tyre Lever, Straight

TSEK



Krom vanadyum, Krom kaplı  
Chrom vanadium, Chrom plated

KOD CODE	L mm	L inch	g	TL/Ad.
6351 26 0400	400	16"	435	5 129,50
6351 26 0500	500	20"	680	5 189,75
6351 26 0600	600	24"	970	5 247,25

(★) İşaretili olan ürünler stoklarla sınırlıdır.  
Limited with stocks.

**6730**

**Çim Kesme Makası (Düz Ağız)**  
*Grass Shears (Straight)*



KOD CODE	L mm	L inch	g	TL/Ad.
6730 27 0550	550	21 5/8"	915	5 293,25

**6722**

**Bağ Makası (Hafif Tip)**  
*Pruning Shears (Light)*



Alüminyum gövde, Daldırma PVC izoleli  
*Aluminum forged body, PVC dipped*

KOD CODE	L mm	L inch	g	TL/Ad.
6722 27 0220	220	8 5/8"	240	5 320,25

**6731**

**Çim Kesme Makası (Eğri Ağız)**  
*Grass Shears (Wave Edges)*



KOD CODE	L mm	L inch	g	TL/Ad.
6731 27 0650	650	25 5/8"	1195	5 524,00

**8011**

**Teşhir Panosu**  
*Display*



**6721**

**Bağ Makası (Lüks)**  
*Pruning Shears (Lux)*



Özel alaşımli çelik, Kesici ağızlar indüksiyonda sertleştirilmiş, Daldırma PVC izoleli  
*Special steel, Cutters induction hardened, PVC dipped*

KOD CODE	L mm	L inch	g	TL/Ad.
6721 27 0205	205	8"	290	5 222,00

KOD CODE	SIZE mm	Cinsi	g	TL/Ad.
8011 31 6001	500x1000x2250	Boş	14000	1 3.710,50

(★) İşaretili olan ürünler stoklarla sınırlıdır.  
*Limited with stocks.*

**IZELTAS®**

# YEDEK PARÇALAR

## SPARE PARTS

Yedek Parçalar  
Spare Parts



**Kurbağacak Anahtar ve Ayarlı Montaj Anahtarları Yedek Parçaları**  
*Adjustable Wrench, Spare Parts*

	KOD CODE	L mm	L inch	g	TL/Ad.
<b>Somun</b> <i>Nut</i>	0600 01 0206	160	6"	5	10 18,00
	0600 01 0208	208	8"	10	10 21,25
	0600 01 0210	260	10"	10	10 28,25
	0600 01 0212	308	12"	20	10 38,75
	0600 01 0215	388	15"	65	10 55,75
<b>Vida</b> <i>Bolt</i>	0600 01 0306	160	6"	3	10 4,50
	0600 01 0308	208	8"	5	10 7,00
	0600 01 0310	260	10"	5	10 8,50
	0600 01 0312	308	12"	10	10 11,25
	0600 01 0315	388	15"	20	10 14,25
<b>Yay</b> <i>Spring</i>	0600 01 0406	160	6"	1	10 3,25
	0600 01 0408	208	8"	1	10 3,25
	0600 01 0410	260	10"	1	10 3,25
	0600 01 0412	308	12"	1	10 3,25
	0600 01 0415	388	15"	3	10 3,25

**2100**
**Stilson Anahtar Yedek Parçaları**  
*Stilson Wrench Spare Part*

	KOD CODE	ÖLÇÜ FOR	g	TL/Ad.
<b>Çene</b> <i>Jaw</i>	2100 10 0108	8"	80	5 126,00
	2100 10 0110	10"	180	5 186,50
	2100 10 0112	12"	320	5 208,00
	2100 10 0114	14"	400	5 250,75
	2100 10 0118	18"	575	5 337,25
	2100 10 0124	24"	980	5 483,00
	<b>Bağlantı Parçası</b> <i>Connection Part</i>	2100 10 0208	8"	60
2100 10 0210		10"	95	5 286,50
2100 10 0212		12"	100	5 313,75
2100 10 0214		14"	195	5 378,75
2100 10 0218		18"	345	5 434,25
2100 10 0224		24"	445	5 649,00
<b>Somun</b> <i>Nut</i>		2100 10 0308	8"	10
	2100 10 0310	10"	30	5 103,25
	2100 10 0312	12"	25	5 107,75
	2100 10 0314	14"	45	5 120,25
	2100 10 0318	18"	75	5 166,00
	2100 10 0324	24"	105	5 181,50

**2110**
**Ağır Tip Boru Anahtarları Yedek Parçaları**  
*Pipe Wrench, Heavy Duty Spare Parts*

	KOD CODE	ÖLÇÜ FOR	g	TL/Ad.	
<b>Çene</b> <i>Jaw</i>	2110 10 0108	8"	100	5 278,25	
	2110 10 0110	10"	205	5 338,00	
	2110 10 0112	12"	235	5 667,00	
	2110 10 0114	14"	400	5 711,50	
	2110 10 0118	18"	675	5 756,00	
	2110 10 0124	24"	900	5 1.133,75	
	2110 10 0136	36"	1820	5 2.267,00	
	2110 10 0148	48"	3410	5 3.733,75	
	<b>Somun</b> <i>Nut</i>	2110 10 0308	8"	10	5 91,50
		2110 10 0310	10"	25	5 96,00
2110 10 0312		12"	35	5 104,75	
2110 10 0314		14"	40	5 127,00	
2110 10 0318		18"	65	5 169,25	
2110 10 0324		24"	115	5 258,00	
2110 10 0336		36"	230	5 478,25	
2110 10 0348		48"	305	5 767,00	

**Alt Çene ve Pim**  
*Lower Jaw and Pin*

2110 10 0408	8"	15	5 293,00
2110 10 0410	10"	40	5 324,75
2110 10 0412	12"	60	5 366,00
2110 10 0414	14"	60	5 377,50
2110 10 0418	18"	90	5 390,75
2110 10 0424	24"	125	5 430,00
2110 10 0436	36"	225	5 686,00
2110 10 0448	48"	285	5 926,00

**2201**
**Maşalı Boru Anahtarları Yedek Somun**  
*Nut*

	KOD CODE	ÖLÇÜ FOR	g	TL/Ad.
<b>Çene</b> <i>Jaw</i>	2201 10 0110	1"	25	10 21,50
	2201 10 0115	1 1/2"	40	10 27,25
	2201 10 0120	2"	60	10 36,00
	2201 10 0130	3"	75	10 48,25
	2201 10 0140	4"	75	10 56,75

**2350**
**Demir Kesme Makası Yedek**  
*Bolt Cutters Spare Part*
**Çene**  
*Jaw*

	KOD CODE	ÖLÇÜ SIZE	KAPASİTE CAPACITY Ø mm	g	TL/Ad.
<b>Çene</b> <i>Jaw</i>	2350 27 0118	18"	6 - 8	850	1 474,50
	2350 27 0124	24"	8 - 10	870	1 544,00
	2350 27 0130	30"	9 - 13	1250	1 962,75
	2350 27 0136	36"	11 - 16	1850	1 1.777,50

## 5850

### Plastik Çekiç Yedek Başlık Plastic Hammer Spare Head



KOD CODE	ØD mm	g	TL/Ad.
5850 25 0130	30	35	10 45,00
5850 25 0140	40	70	10 64,00
5850 25 0150	50	120	10 91,75

## 6400

### Keser Yedek Sapı / Adze Handle



KOD CODE	L mm	g	TL/Ad.
6400 25 0001	400	140	10 58,25

## 5800

### Tesviyeci Çekiç Yedek Sapı (Kamalı) Hammer Handle (With Pin)



KOD CODE	L mm	g	g	TL/Ad.
5800 25 0001	260	100	60	10 46,25
5800 25 0002	280	200	60	10 46,50
5800 25 0003	300	300	95	10 52,00
5800 25 0005	320	500	100	10 58,25
5800 25 0010	360	1000	165	10 75,50
5800 25 0015	380	1500	185	10 85,00
5800 25 0020	400	2000	205	10 91,50

## 5865

### Madırğa Yedek Sap (Kamalı) Mallet Handle (With Pin)



KOD CODE	L mm	g	TL/Ad.
5865 25 0001	260	1000	10 54,50
5865 25 0002	280	1500	10 59,75

## 6410

### Nacak Yedek Sap (Kamalı) Hatchet Handle (With Pin)



KOD CODE	L mm	g	g	TL/Ad.
6410 25 0001	380	800	250	10 175,75

## 03755

### Kablo Sıyrıcı Yedek Bıçağı Cable Strippers Spare Blade



KOD CODE	ÖLÇÜ SIZE	g	TL/Ad.
03755 50 625	Tek 6/300 Çok 1,5/25	25	5 64,00

## 06375

### Ayarlı Yağ Filtresi Sökeceği Yedek Kelepçe Adjustable Slot Type Oil Filter Wrench Spare Clamp



KOD CODE	Ø mm	g	TL/Ad.
06375 50 010	65	20	5 52,00



## 6230

Gres Pompası Yedek Ucu  
Grease Gun Nozzle



500cc  
300cc

KOD CODE	L mm	Ø mm	g	TL/Ad.
6230 26 2500	38	15	31	10
				41,50

Hortumu  
Hose for  
Grease Gun



KOD CODE	Ø mm	L mm	g	TL/Ad.
6230 26 3300	8	300	34	10
				47,25
6230 26 3500	12	500	102	10
				86,50

## 05898

HSS Testere Laması  
Hacksaw Blade HSS



KOD CODE	ÖLÇÜ SIZE	g	TL/Ad.
05898 50 283	13x0.65x18	20	100
			44,00

## 05899

Bimetal Testere Laması  
Hacksaw Blade Bimetal



KOD CODE	ÖLÇÜ SIZE	g	TL/Ad.
05899 50 283	13x0.65x18	20	100
			51,50

## 6735

Dal Budama Testeresi Yedek Bıçak  
Spare Blade for Pruning Saw



KOD CODE	L mm	g	TL/Ad.
6735 27 1300	300	60	5
			387,75

## 06765

Plastik Boru Kesme Makası Bıçağı  
Plastic Pipe Cutter Spare Blade



KOD CODE	ÖLÇÜ SIZE	g	TL/Ad.
06765 50 042	42	73	5
			615,75
06765 50 063	63	105	5
			1.143,50

## 6850

Mini Boru Kesici Bıçağı / Blade For Mini Tube Cutter  
Standart Boru Kesici Bıçağı / Blade For Standard Tube Cutter  
Teleskopik Boru Kesici Bıçağı / Blade For Telescopic Tube Cutter



KOD CODE	ÖLÇÜ SIZE	g	TL/Ad.
6850 28 1322	1/4" - 1 3/8"	5	10
			68,75

## 6865

Profesyonel Boru Kesici Bıçağı  
Blade For Professional Tube Cutter



KOD CODE	ÖLÇÜ SIZE	g	TL/Ad.
6865 28 0150	1/8" - 2"	30	5
			142,75



## 7010-7020

### Standart Çektirme Yedek Parçaları Spare Parts For Standard Pullers

#### Uzatma Parçası / Connection Part, Extention



KOD CODE	L mm	KULLANILAN ÇEKTİRME FOR	g	TL/Ad.
7010 29 2033	200	8x10 - 12x10	415	209,75
7010 29 3033	300	16x15 - 20x15	890	365,00
7010 29 4033	400	25x20 - 35x20 37x20 - 52x20	2350	540,00

#### Kol / Arm



KOD CODE	KULLANILAN ÇEKTİRME FOR	g	TL/Ad.
7010 29 0822	8x10 - 12x10	110	157,75
7010 29 1622	16x15 - 20x15	330	274,50
7010 29 2522	25x20 - 35x20 52x20 - 37x20	775	481,00

#### Bağlantı Parçası / Connection Part



KOD CODE	KULLANILAN ÇEKTİRME FOR	g	TL/Ad.
7010 29 0833	8x10 - 12x10	160	79,75
7010 29 1633	16x15 - 20x15	325	137,50
7010 29 2533	25x20 - 35x20 52x20 - 37x20	930	240,75

#### Mil / Spindle



KOD CODE	KULLANILAN ÇEKTİRME FOR	g	TL/Ad.
7010 29 0844	8x10 - 12x10	185	144,25
7010 29 1644	16x15 - 20x15	555	275,50
7010 29 2544	25x20	1400	474,00
7010 29 3544	35x20 - 37x20	2185	617,75
7010 29 5244	52x20	3210	617,75

## 7030-7040

### Master Çektirme Yedek Parçaları/Spare Parts For Master Puller

#### Kol / Arm



KOD CODE	KULLANILAN ÇEKTİRME FOR	g	TL/Ad.
7030 29 0822	8x8	110	86,25
7030 29 1222	12x12	215	119,75
7030 29 1622	16x16	345	213,75
7030 29 2322	23x20	580	290,75

#### Mil/Spindle



KOD CODE	KULLANILAN ÇEKTİRME FOR	g	TL/Ad.
7030 29 0844	8x8	180	117,25
7030 29 1244	12x12	360	172,50
7030 29 1644	16x16	680	190,50
7030 29 2344	23x20	1230	261,00

## 7050-7060

### Batarya Çektirme Yedek Parçaları Spare Parts For Battery Pullers

#### Kol / Arm



KOD CODE	KULLANILAN ÇEKTİRME FOR	g	TL/Ad.
7050 29 0422	6x4	40	67,25
7050 29 0622	6x6	50	75,25
7050 29 0822	8x8	110	86,25

#### Mil / Spindle



KOD CODE	KULLANILAN ÇEKTİRME FOR	g	TL/Ad.
7050 29 0444	6x4	95	100,00
7050 29 0644	6x6	105	111,75
7050 29 0844	8x8	200	140,75

## 7070-7080

### S Tipi Çektirme Yedek Parçaları Spare Parts For S Type Puller

#### Kol / Arm



KOD CODE	KULLANILAN ÇEKTİRME FOR	g	TL/Ad.
7070 29 2022	20x13	405	172,75

#### Mil / Spindle



KOD CODE	KULLANILAN ÇEKTİRME FOR	g	TL/Ad.
7070 29 2044	20x13	520	241,00

## 7090-7100

### Üniversal Çektirme Yedek Parçaları Spare Parts For Universal Puller

#### Kol / Arm



KOD CODE	KULLANILAN ÇEKTİRME FOR	g	TL/Ad.
7090 29 2322	22x22	690	192,00

#### Mil / Spindle



KOD CODE	KULLANILAN ÇEKTİRME FOR	g	TL/Ad.
7090 29 2244	22x22	565	253,75



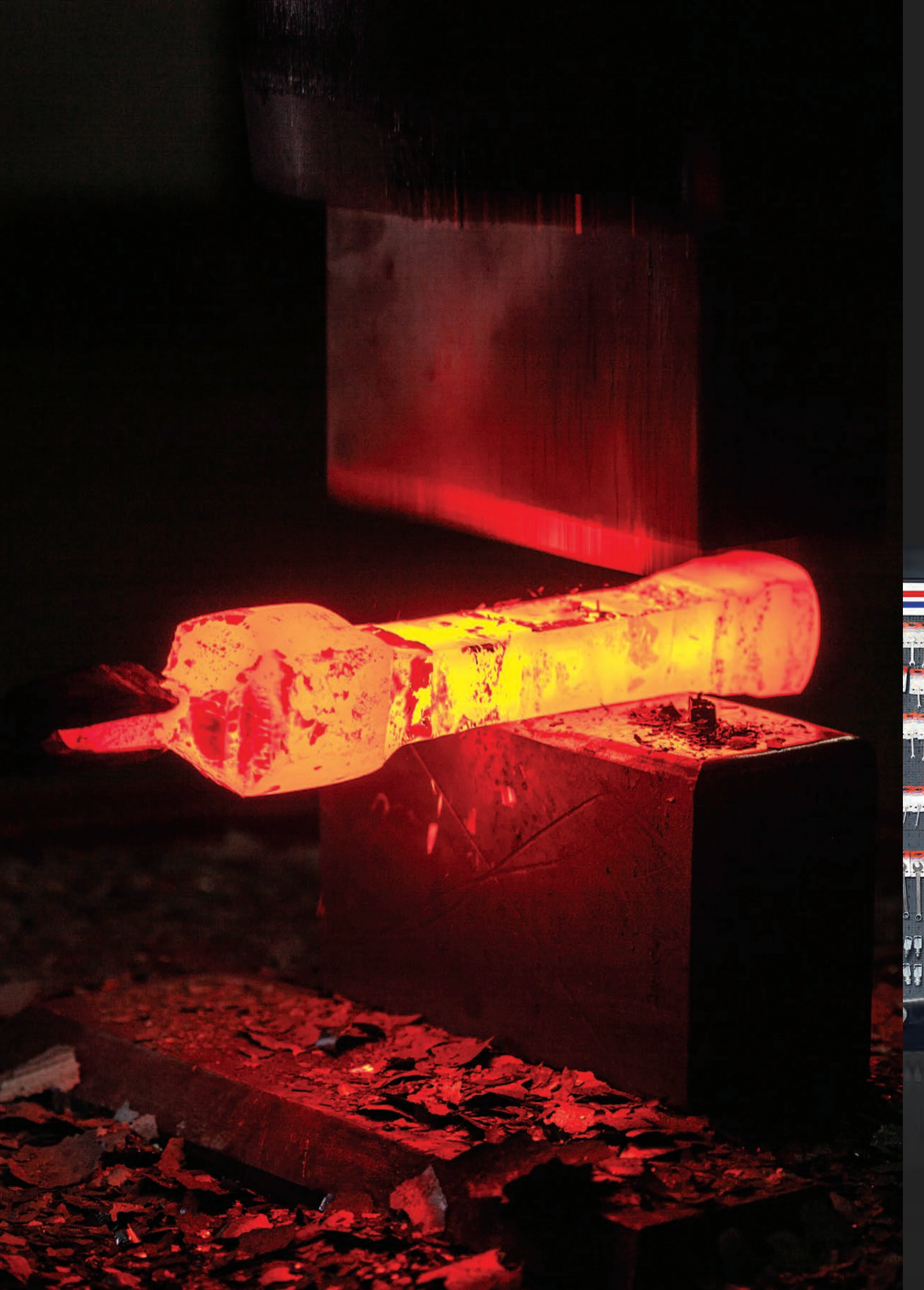



**IZELTAS®**

# TİCARİ TEŞHİR ÜRÜNLERİ

## COMMERCIAL DISPLAY PRODUCTS

Ticari Teşhir Ürünleri  
Commercial Display Products

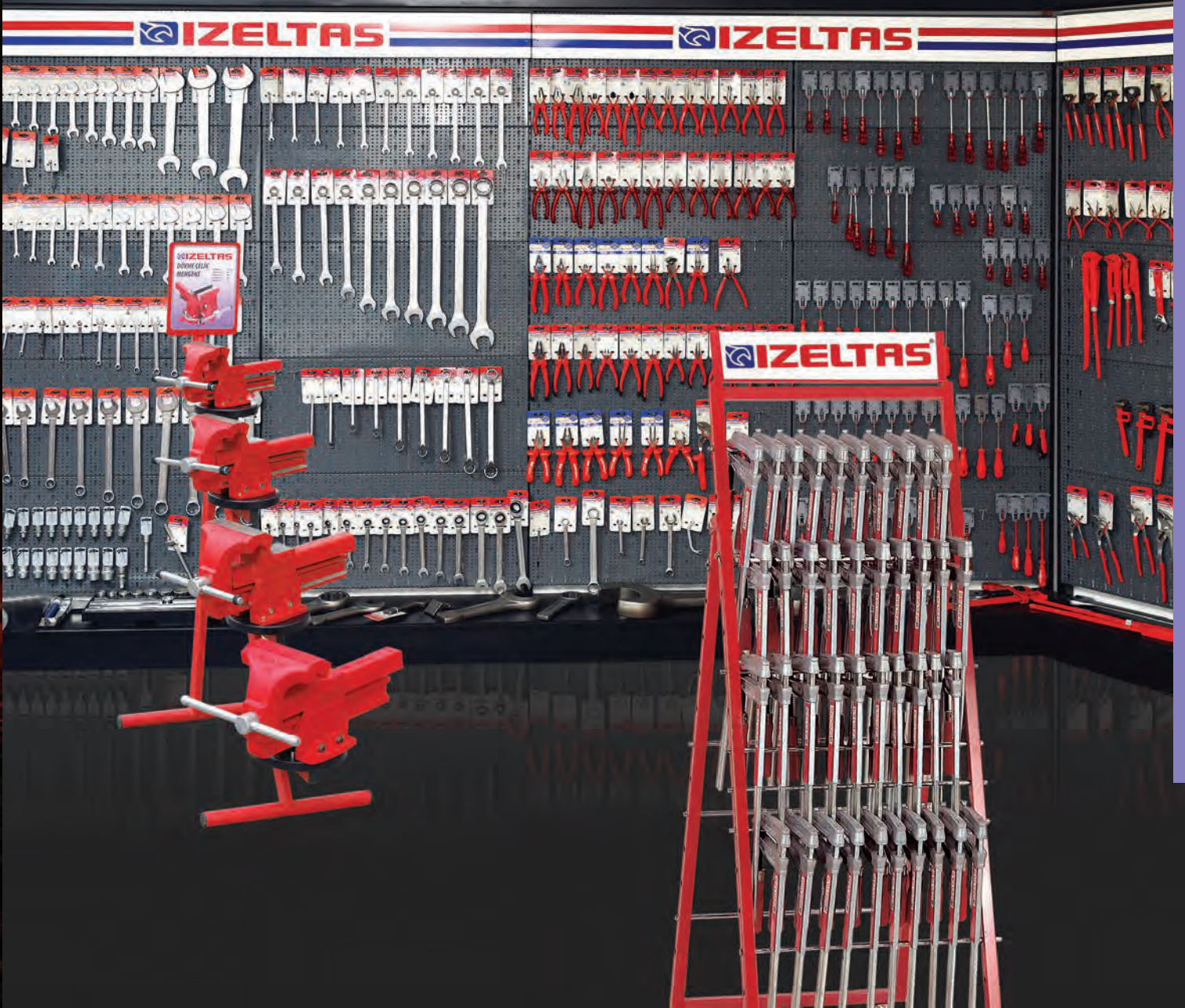

COMMERCIAL  
DISPLAY STANDS

TİCARİ TEŞHİR  
STANDLARI

**1113****1/2" Lokma Anahtar Sehpası**  
*Display Frame for Sockets***1/2"**

KOD CODE	ÖLÇÜ SIZE mm	g	TL/Ad.	
1113 31 6100	175x360x605	5800	1	1.121,00

**7010****Çektirme Sehpası**  
*Display Frame For Pullers*

KOD CODE	İÇERİK CONTENTS	g	TL/Ad.	
7010 31 6105	Boş - Empty	2000	1	324,75

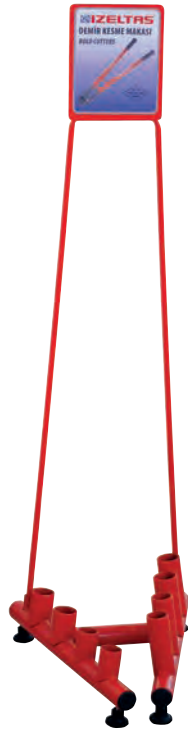
**2350****Demir Kesme Makası Sehpası**  
*Display Frame for Bolt Cutters*

KOD CODE	İÇERİK CONTENTS	g	TL/Ad.	
2350 31 6104	Boş - Empty	7400	1	1.546,00

**7300****İşkence Sehpası**  
*Display Frame for Screw Clamps*

KOD CODE	ÖLÇÜ SIZE mm	g	TL/Ad.	
7300 31 6150	100x520x1420	8000	1	1.329,00

## 8001-8002

### Çatal ve Yıldız Anahtar Sehpası Display Frame For Wrenches



Sacdan imal edilmiş, Fırın boya  
Made from metal sheet, Electrostatic paint

KOD CODE	ÖLÇÜ SIZE mm	g	İÇERİK CONTENTS	TL/Ad.
8001 31 6012	160x500	800	Çatal / Open Jaw	1 172,50
8002 31 6012	170x560	1000	Yıldız / Ring	1 215,25

## 8004

### Dövme Çelik Mengene Sehpası Forged Steel Vice Frame



KOD CODE	İÇERİK CONTENTS	g	TL/Ad.
8004 31 6004	Boş - Empty	8000	1 1.647,50

## 8015

### Tekerlekli Üçgen Teşhir Standı Triangular Display Frame



Sacdan imal edilmiş, Fırın boya  
Made from metal sheet, Electrostatic paint

KOD CODE	ÖLÇÜ SIZE mm	g	TL/Ad.
8015 31 6001	520x1670	29500	1 2.336,25



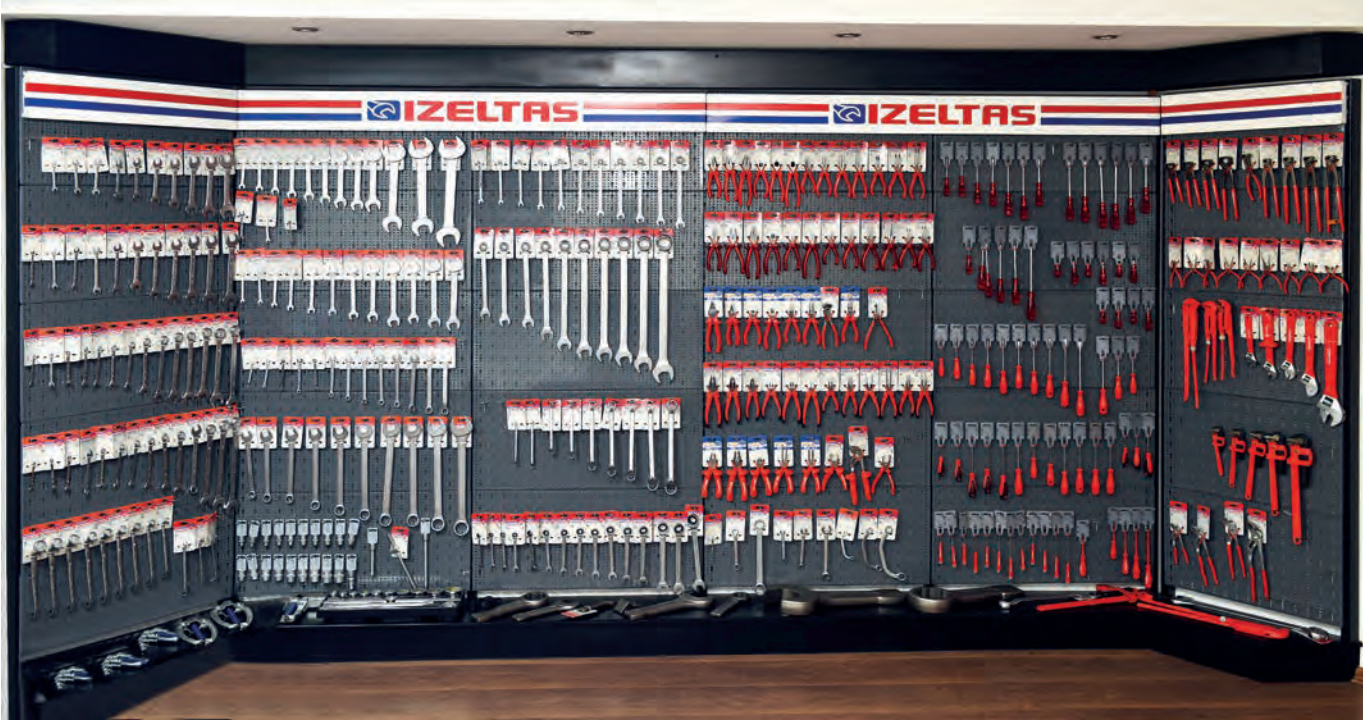

İzeltaş El Aletleri Teşhir Panosu, satış noktaları için özel olarak dizayn edilmiştir. Kolayca monte edilebilen 19 ana parçadan oluşan panonun derinliği 46 cm, genişliği 100 cm, yüksekliği 220 cm'dir. Etkili görünümü ve tüm ürünleri bir arada sergileme özelliği yanında, perakende satışlarda seçme kolaylığı sağlaması bakımından da önem taşımaktadır.

İzeltaş's Product Exhibition Board has been specially designed for selling points. These boards have been formed from easily mountable 19 main parts and have the dimensions as following, width 46 cm, length 100 cm and height 220 cm.

Board features an impressive looking and displays the products all together, which makes it easy to choose desired tools during retail selling activities.

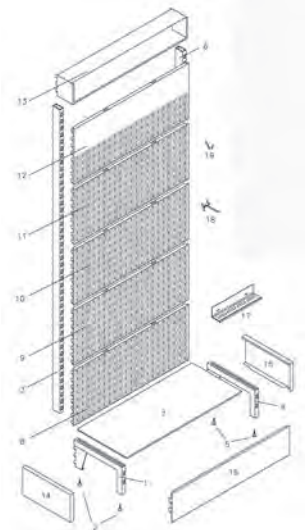

**Büyük Pano**  
**Display Panel (Empty)**

#### Montaj Sırası / Montage Order

1. Ayak / Stand right leg
2. Plastik ayak / Plastic leg
3. Kolon / Stand right column
4. Ayak / Stand left leg
5. Plastik ayak / Plastic leg
6. Kolon / Stand left column
7. Raf / Shelf
8. Delikli pano / Drilled panel
9. Delikli pano / Drilled panel
10. Delikli pano / Drilled panel
11. Delikli pano / Drilled panel
12. Yarım delikli pano / Half - drilled panel
13. Aydınlatma alınlığı / Illumination panel
14. Yan kapak / Side cover
15. Yan kapak / Side cover
16. Ön kapak / Front cover
17. Tornavida askısı / Screwdriver hanger
18. Büyük askı / Long hanger
19. Küçük askı / Short hanger

KOD CODE	ÖLÇÜ SIZE mm	Cinsi	g	TL/Ad.
8010 31 6001	460x1000x2200	Boş/Empty	43000	1 4.483,50

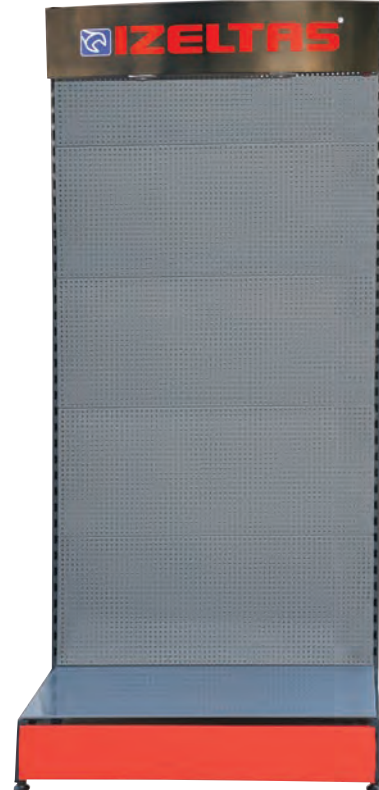

# TEKNİK BİLGİLER

## TECHNICAL INFORMATION

Teknik Bilgiler  
Technical Informations

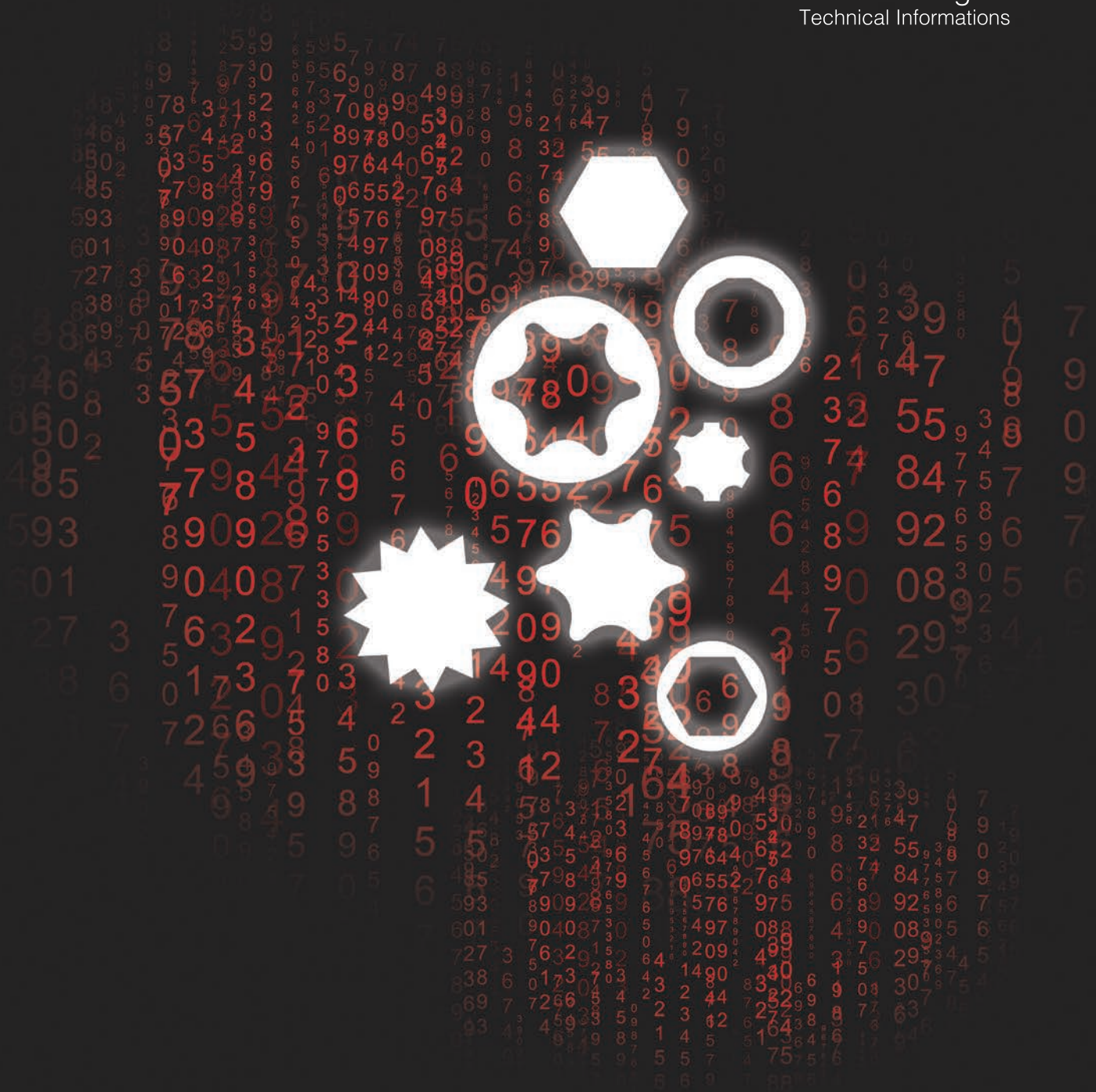

## İş Güvenliği ve El Aletlerinin Yanlış Kullanımı



**Elektrik akımı geçme (1000V üzeri hariç) ihtimali olan tüm yerlerde IEC 60900'a göre izoleli uygun el aletleri kullanılmalıdır.**  
Hand tools with IEC 60900 compliant isolation must be used for any work involving risk of electrical current (excluding 1000V and above).



**Tozlu ve çapaklı alanlarda mutlaka gözlük kullanınız.**  
Make sure to wear goggles in work areas with dust and burrs.



**Lokma anahtarlarınızı uygun ölçülerdeki civatada, en geniş yüzeyde dik olarak kullanınız. Lokma anahtarların civataya eğik olarak takılıp kullanılması, kavrama yüzeyini azaltarak ürünün kullanım ömrünü kısaltacaktır.**  
Use box wrenches with bolts of appropriate size, placed perpendicularly on the largest area of contact. Use of a box wrench at an angle will reduce the gripping surface and result in a shorter useful life.



**Yüksek sesli ortamlarda mutlaka kulaklık kullanınız.**  
Make sure to wear ear protection in work areas with high levels of noise.



**Çekici amacı dışında kendinden daha sert malzemelere vurmeyiniz, eğik olarak kullanmayınız. Mantarlaşmış bölgeleri mutlaka temizleyerek kullanınız.**  
Do not use a hammer outside its intended purpose or to hit objects harder than the hammer. Do not hit at an angle. Make sure to clean weakened parts before use.



**Kimyasal madde içeren işlerde mutlaka eldiven ve maske kullanınız.** Make sure to wear gloves and facemask for works involving chemical materials.

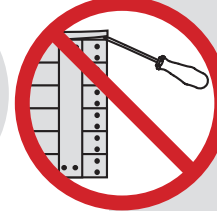

**Tornavidayı amacı dışında sökme işlemlerinde kullanmayınız.**  
Do not use the screwdriver as a levering tool out of its intended purpose.



**Anahtarlarınızı, ağız ölçüsüne uygun civatalarda kullanınız. Anahtar ve civatadaki ölçü uyumsuzluğu, üründen ağız aşınmasına neden olur.**  
Use wrenches with bolts of appropriate size. Size discrepancy between wrench and bolt will lead to wear on tool edge.



**Tornavidayı amacı dışında keski gibi ya da darbeli olarak kullanmayınız.**  
Do not use the screwdriver as a chiselling tool or for impacting out of its intended purpose.



**Anahtarların ağızına taşlama işlemi yapmayınız; sert cisimler sürterek müdahale etmeyiniz. Bu durum anahtarınızın ağız yapısını bozar.**  
Do not grind or expose the edge of wrenches to hard objects. This will deform the tool edge structure.



**Dolapları çekerek değil iterek kullanınız.**  
Do not pull the set cabinets. Push to move the cabinets.



**Anahtar gövdesine boru takarak kuvvet uygulamayınız. Anahtarınızın ağız yapısının bozulmasına, kırılmalara ve yaralanmalara neden olabilir.**  
Do not apply force to the wrench by attaching a pipe to the tool body. This may result in deformation of tool edge, breakage or injury.



**Dolapların birden fazla çekmesini aynı anda açık bırakmayınız. Ağırlık merkezi değişerek dolabın devrilmesine neden olacaktır.**  
Do not leave multiple drawers of set cabinets open at the same time. This will move the centre of gravity and cause toppling.



**Anahtar gövdesine çekiç ile darbe uygulamayınız. Ağız yapısında bozulmalara, kırılma ve yaralanmalara neden olabilir.**  
Do not hit the wrench body with a hammer. This may result in deformation of tool edge, breakage or injury.



**Dolapların çekmecelerini ayağınızla kapatmaya ya da basamak, merdiven olarak kullanmaya çalışmayınız. Bu gibi durumlar yaralanmalara sebep olacaktır.**  
Do not use your foot to close a cabinet drawer or attempt to use cabinet drawers as a stepladder. Such actions will result in injury.

## TEKNİK BİLGİLER/TECHNICAL DATA

### ANAHTAR AĞZI ÖLÇÜLERİ VE VİDA ÇAPLARI SPANNER JAW WIDTH ACCROSS FLATS and THREAD DIAMETERS

mm	DIN ISO 272 ye göre metrik	DIN ISO 272 ye göre metrik	AF	Ağız Genişliği		Civata Çapı Whitw. BS 916 1083	Ağız Genişliği	
				inch	mm		inch	mm
4	2		5/32	0,1562	3,97	8 BA	0,152	3,86
4,5	2,3					7 BA	0,172	4,87
5	2,5		3/16	0,1875	4,76	6 BA	0,193	4,90
5,5	3,5		7/32	0,2187	5,56	5 BA	0,220	5,59
6	26,8		1/4	0,2500	6,35	4 BA	0,248	6,30
						1/16 W	0,256	6,50
7	4		9/32	0,2812	7,14	3 BA	0,282	7,16
						3/32 W	0,297	7,54
7-8	5		5/16	0,3125	7,94	2 BA	0,324	8,23
9	5 Alt		11/32	0,3438	8,73	1/8 W (3/16)	0,340	8,64
			3/8	0,3750	9,52	1 BA	0,365	9,27
8-10	6		13/32	0,4062	10,32	0 BA (7/32)	0,413	10,49
11	7		7/16	0,4375	11,11	3/16 W 1/4	0,445	11,30
12								
10-13	8		1/2	0,5000	12,70	1/4 W 5/16	0,525	13,34
14*	8 Alt		9/16	0,5625	14,29			
15	10 KFZ		19/32	0,5938	15,08	5/16 W 3/8	0,600	15,24
16	10		5/8	0,6250	15,88			
13-15-17	10		11/16	0,6875	17,46			
18	12					3/8 W 7/16	0,710	18,03
15-18-19	12		3/4	0,7500	19,05			
20*			25/32	0,7812	19,84			
18-21	14		13/16	0,8125	20,64	7/16 W 1/2	0,820	20,83
22-24	14	12	7/8	0,8750	22,22			
23*						1/2 W 9/16	0,920	23,37
21-24*	16		15/16	0,9375	23,81			
25*-27*		1,	1,0000	25,40				
26*						9/16 W 5/8	1,010	25,65
27	18	16	1.1/16	1,0625	26,99			
27-28*-30						5/8 W (11/16)	1,100	27,94
			1.1/8	1,1250	28,58			
27-30-34	20		1.3/16	1,1875	30,16	11/16 W 3/4	1,200	30,48
32-36-41	22	20	1.1/4	1,2500	31,75			
			1.5/16	1,3125	33,34	3/4 W 7/8	1,300	33,02
34	22		1.3/8	1,3750	34,92	13/16 W (15/16)	1,390	35,31
36-41	24	22	1.7/16	1,4375	36,51			
38*			1.1/2	1,5000	38,10	7/8 W 1	1,480	37,59
41-46	27	24	1.5/8	1,6250	41,28			
			1.11/16	1,6875	42,86	1. W 1.1/8	1,670	42,42
			1.3/4	1,7500	44,45			
46-50	30	27	1.13/16	1,8125	46,04	1.1/8 W 1.1/4	1,860	47,24
			1.7/8	1,8750	47,62			
50-55	33	30	2,	2,0000	50,80			
			2.1/16	2,0625	52,39	1.1/4 W 1.3/8	2,050	52,07
55-60	36		2.3/16	2,1875	55,56			
			2.1/4	2,2500	57,15	1.3/8 W 1.1/2	2,220	56,39
60-65	39	36	2.3/8	2,3750	60,32			
			2.7/16	2,4375	61,91	1.1/2 W 1.5/8	2,410	61,21
65	42		2.9/16	2,5625	65,09	1.5/8 1.3/4	2,580	65,53
			2.5/8	2,6250	66,68			
70	45		2.3/4	2,7500	69,85	1.3/4 W 2,	2,760	70,10
			2.13/16	2,8125	71,44			
75	48		2.15/16	2,9375	74,61			
			3,	3,0000	76,20	(1.7/8 W)		76,70
80	52		3.1/8	3,1250	79,38	2. W 2.1/4	3,150	80,01
85	56		3.3/8	3,3750	85,72			
90	60		3.1/2	3,5000	88,90		2.1/2	3,550
95	64		3.3/4	3,7500	92,25			
			3.7/8	3,8750	98,42		2.3/4	3,890
100	68							
105	72		4.1/8	4,1250	104,78		3,	4,180
110	76		4.1/4	4,2500	107,95			
115*	80		4.1/2	4,5000	114,30		3.1/4	4,530

### ANAHTAR İÇİN MİNİMUM DÖNDÜRME MOMENTLERİ TEST TORQUE VALUES FOR SPANNERS ISO 1711-1

mm	0430	0440	0100	1800	1870
0320			0130		1874
0330					
0370					
4			1,90		
4.5*			2,64		
5			3,55		
5,5			4,64		
6*	17,6	7,4	5,92	17,6	
7	25,2	11,4	9,12	25,2	
8	34,5	16,6	13,3	34,5	34,5
9*	45,5	23,0	18,4	45,5	45,5
10	58,1	31,0	24,8	58,1	58,1
11	72,7	40,4	32,3	72,7	72,7
12	89,1	51,5	41,2	89,1	89,1
13	107	64,5	51,6	107	107
14*	128	79,4	63,5	128	128
15	150	96,2	77,0	150	150
16	175	115	92,3	175	175
17	201	134	107	201	201
18	230	160	128	230	230
19*	261	186	149	261	261
20*	294	215	172	294	294
21	330	247	198	330	330
22*	368	281	225	368	368
23*	408	319	255	408	408
24	451	359	287	451	451
25*	496	402	322	496	496
26*	544	449	359	544	544
27	594	499	399	594	594
28*	647	552	442	647	647
30	760	670	536	760	760
32*	884	804	643	884	884
34	1019	951	761	1019	1019
36	1165	1117	994	1165	1165
41	1579	1442	1154	1579	1579
46	2067	1816	1453	2067	2067
50	2512	2145	1716	2512	2512
55	3140		2077	3140	3140
60	3849		2471	3849	
65	4021				
70	4658				
75	5394				

\* Standart dışı/Not Standardised

**VİDA AĞIZ ÖLÇÜLERİ**  
**GUIDELINE FOR SCREWDRIVERS**

											
"Metrik Vida Metric screw"	<b>M 1.6</b> (M 1.7)	<b>M 2</b>	<b>M 2.3</b>	<b>(M 2.3)</b> (M 2.6)	<b>M 3</b>	<b>(M 3.5)</b>	<b>M 4</b>	<b>M 5</b>	<b>M 6</b>	<b>M 8</b>	<b>M 10</b>
Düz başlı Vidalar Flat head screws	0.4 x 3 (3.2)	0.5 x 3.8	0.6 x 4.4	0.6 x 4.5 (5)	0.8 x 5.5	0.8 x 6	1 x 7	1.2 x 8.5	1.6 x 10	2 x 13	2.5 x 16
Düz başlı Vidalar Flat head screws	—	—	—	—	0.8 x 6	0.8 x 7	1 x 8	1.2 x 10	1.6 x 12	2 x 16	2.5 x 20
Düz başlı Vidalar (küçük) Flat head screws (small sizes)	—	—	—	0.4 x 3.5	0.5 x 4	0.5 x 4.5	0.6 x 5.5	0.8 x 6.5	1 x 8	1.2 x 10	1.6 x 13
Oval başlı Vidalar Oval head screws	0.4 x 3	0.5 x 3.8	—	0.6 x 4.7	0.8 x 5.6	—	—	—	—	—	—
Havşa başlı Vidalar Countersank head screws	0.4 x 3	0.5 x 3.8	—	0.6 x 4.7	0.8 x 5.6	0.8 x 6.5	1 x 7.5	1.2 x 9.2	1.6 x 11	2 x 14.5	2.5 x 18

**YILDIZ VİDALAR İÇİN UYGUN TORNAVİDA AĞIZ ÖLÇÜLERİ**  
**SUITABLE TIPS FOR CROSS HEAD SCREWS**

		
Yıldız Ağız Ölçüsü Cross Slot Size		Metrik Vidalar Metric Screw
0		M 1.6 - M 2
1		M 2 - M 2.5 - M 3
2		M 3.5 - M 5
3		M 6
4		M 8 - M 10





## TEKNİK BİLGİLER/TECHNICAL DATA

### METRİK VİDALAR İÇİN LOKMA SEÇİMİ GUIDE TO METRIC SIZES COVERED BY SOCKET WRENCHES FOR EACH DRIVE

	1107 6.3	1110 10	1113 12.5	1119 20	1125 25		
	1/4"	3/8"	1/2"	1/2"	3/4"	3/4"	1"
M 2	4						
	4,5						
M 2.5	5						
M 3	5,5						
M 3.5	6	6					
M 4	7	7					
M 5	8	8	8				
	9	9	9				
M 6	10	10	10	10			
M 7	11	11	11	11			
	12	12	12	12			
M 8	13	13	13	13			
		14	14	14			
		15	15	15			
M 10		16	16	16			
M 10		17	17	17	17		
M 12		18	18	18	18	18	
M 12		19	19	19	19	19	
		20	20				
M 14		21	21	21	21		
M 14		22	22	22	22	22	22
		23	23	23			
M 16			24	24	24	24	24
			25				
			26				
M 18			27	27	27	27	27
			28				
M 20			30	30	30	30	30
M 22			32	32	32	32	32
				33	33	33	33
M 22			34	34	34	34	34
M 24				36	36	36	36
				38	38	38	38
M 27				41	41	41	41
						42	
M 30					46	46	46
M 33					50	50	
M 36					55	55	
M 39					60	60	
M 42						65	
M 45						70	
M 48						75	
M 52							

### LOKMA İÇİN MİN DÖNDÜRME MOMENTLERİ TEST TORQUE VALUES FOR SOCKET ISO 1711-1 (N-m)

		6,3 1107	10 1110	12,5 1113 1114	20 1119 1120	25 1125
	mm	1/4	3/8	1/2	3/4	1
M2	4	10,4				
M 2.2	4,5*	12,6				
M 2.5	5	15,1				
M 3	5,5	17,8				
M 3.5	6*	20,6	23,2			
M 4	7	26,8	33,2			
M 5	8	33,6	45,5	94,1		
	9*	41,1	59,9	119,2		
M 6	10	49,1	76,7	147		
M 7	11	57,8	96	178		
	12	67,0	118	212		
M 8	13	68,6	141	249		
	14*	68,6	169	288		
	15		198	331		
	16		225	377		
M 10	17		225	425		
	18		225	477		
M 12	19*		225	531		
	20*		225	569		
	21		225	569	-	
M 14	22*		225	569	569	
	23*			569	569	
M 16	24			569	569	
	25*			569	583	
	26*			569	624	
M 18	27			569	665	
	28*			569	707	
M 20	30			569	795	
M 22	32*			569	888	
	34			569	984	
M 24	36				1084	1677
M 27	41				1353	1910
M 30	46				1569	2143
M 33	50				1569	2329
M 36	55				1569	2562
M 39	60				1569	2795
M 42	65					2795
M 45	70					2795
M 48	75					2795
M 52	80					2795

# SIKMA / TEST TORK DEĞERLERİ TIGHTENING / TEST TORQUE VALUES

Önerilen (Bağlayıcı olmayan) civata sıkma torkları Nm (Newton Metre)  
Suggested (Not Compulsory) Bolt Tightening Torque in Nm (Newton Meter)

**Kalite Sınıfı DIN 267'ye Göre Sıkma Değerleri**  
Tightening Torques Values According to Quality Class DIN 267

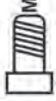
	4.6	5.6	6.9	8.8	10.9	12.9
M 2	0,123	0,162	0,314	0,373	0,520	0,628
M 2,2	0,196	0,265	0,510	0,598	0,843	1,010
M 2,5	0,284	0,373	0,726	0,863	1,206	1,451
M 3	0,441	0,588	1,128	1,344	1,883	2,256
M 3,5	0,677	0,902	1,736	2,060	2,893	3,481
M 4	1,000	1,344	2,599	3,040	4,315	5,148
M 5	1,916	2,648	5,099	6,031	8,483	10,200
M 6	3,432	4,511	8,728	10,300	14,710	17,652
M 7	5,590	7,453	14,220	17,162	24,517	28,439
M 8	8,238	10,787	21,575	25,497	35,304	42,168
M 10	16,67	21,575	42,168	50,014	70,608	85,317
M 12	28,44	38,246	73,550	87,279	122,60	147,10
M 14	45,11	60,801	116,70	138,30	194,20	235,40
M 16	69,63	93,163	178,5	210,80	299,10	357,90
M 18	95,12	127,50	245,20	289,3	411,90	490,30
M 20	135,3	180,45	384,10	411,90	578,60	696,30
M 22	182,4	245,16	470,70	559,00	784,50	941,40
M 24	230,5	308,91	598,20	711,00	1000	1196
M 27	343,2	460,90	887,50	1049	1481	1775
M 30	465,8	622,72	1206	1422	2010	2403
M 33	632,5	848,30	1628	1932	2716	3266
M 36	814,0	1089	2099	2481	3491	4197
M 39	1059	1412	2716	3226	4531	5443
M 42	1304	1746	3364	3991	5609	6727
M 45	1638	2177	4207	4992	7012	8414
M 48	1981	2638	5080	6021	8473	10150
M 52	2540	3393	6541	7747	10885	13092
M 56	3168	4227	8149	9650	13582	16279
M 60	3932	5247	10101	11964	16867	20202
M 64	4737	6306	12160	14416	20300	24320

**Moment Değerleri Yağlanmış Civatalar İçin %20 Azaltılmalıdır.**  
Torque Values Should be Decreased of 20% for Lubricated Screws

## Ölçü Birimleri Measuring Units

Giga	G	1.000.000.000	=10 <sup>9</sup>	1GW= 1 Milyar Watt
Mega	M	1.000.000	=10 <sup>6</sup>	1 MW= 1 Milyon Watt
Kilo	k	1.000	=10 <sup>3</sup>	1 kW= Bin Watt
Milli	m	0.001	=10 <sup>-3</sup>	1 mm= Binde Bir Watt
Mikro	m	0.000001	=10 <sup>-6</sup>	1 mm= 1 Milyonda Bir Watt
Nano	n	0.000000001	=10 <sup>-9</sup>	1 nm= 1 Milyarda Bir Watt

## Önemli Ölçülerin Değişim Tablosu Conversion Table For Essential Measuring Units

Uzunluk Length	Metre	m	
Kütle Weight	Kilogram	kg	
Zaman Time	Saniye	s	
Kuvvet Force	Newton	N	=kg m/s <sup>2</sup> 1 N= 0.102 kp
Döndürme Mom. Torque	Newtonmetre		9.81 Nm= 1kpm
İş Enerjisi Work	Joule	J	=Nm
Isı Enerjisi Heat	Joule	J	1 J= 0.239 cal
Güç Power	Watt	W	=Nm/s 1 kW= 1.36 PS=860 kcal/h
Basınç Pressure	Pascal	Pa	=N/m <sup>2</sup> 100.000 Pa=1 bar=10 mWS
Elektrik Akımı Electricity Current	Amper	A	
Sıcaklık Temperature	Kelvin	K	1K= -272.15 °C

## Newton-Metre ve Librefoot Dönüşüm Tablosu Conversion Table Of Newton-Meter And Librefoot (1 Nm=0.738 lbf.ft.)

Nm	ft.,lbs.									
	0	1	2	3	4	5	6	7	8	9
0	0	0.74	1.48	2.21	2.95	3.69	4.43	5.17	5.90	6.64
10	7.38	8.12	8.86	9.59	10.33	11.07	11.81	12.54	13.28	14.02
20	14.76	15.50	16.2	16.97	17.71	18.45	19.19	19.93	20.65	21.40
30	22.14	22.88	23.62	24.35	25.10	25.83	26.57	27.31	28.04	28.78
40	29.52	30.26	31.00	31.73	32.47	33.21	33.95	34.69	35.42	36.16
50	36.90	37.64	38.38	39.11	39.85	40.59	41.33	42.07	42.80	43.54
60	44.28	45.02	45.76	46.49	47.23	47.97	48.71	49.45	50.18	50.92
70	51.66	52.40	53.14	53.87	54.61	55.35	56.09	56.83	57.56	58.30
80	59.04	59.78	60.52	61.25	62.00	62.73	63.47	64.21	64.94	65.68
90	66.42	67.16	67.90	68.63	69.37	70.11	70.85	71.59	72.32	73.06
100	73.80	74.54	75.28	76.01	76.75	77.49	78.23	78.97	79.70	80.44

## Librefoot ve Newton-Metre Dönüşüm Tablosu Conversion Table Of Librefoot And Newton-Meter (1 lbf.ft.=1.356 Nm)

ft.- lbs.	Nm									
	0	1	2	3	4	5	6	7	8	9
0	0	1.36	2.71	4.07	5.42	6.78	8.14	9.49	10.85	12.20
10	13.56	14.92	16.27	17.63	18.98	20.34	21.70	23.05	24.41	25.76
20	27.12	28.48	29.83	31.19	32.54	33.90	35.26	36.61	37.97	39.32
30	40.68	42.04	43.39	44.75	46.10	47.46	48.82	50.17	51.53	52.88
40	54.24	55.60	56.95	58.31	59.66	61.02	62.38	63.73	65.09	66.44
50	67.80	69.16	70.51	71.87	73.22	74.58	75.94	77.29	78.65	80.00
60	81.36	82.72	84.07	85.43	86.78	88.14	89.50	90.85	92.21	93.56
70	94.92	96.28	97.63	98.99	100.34	101.70	103.06	104.41	105.77	107.12
80	108.48	109.84	111.19	112.55	113.90	115.26	116.62	117.97	119.33	120.68
90	122.04	123.40	124.75	126.11	127.46	128.82	130.18	131.53	132.89	134.24
100	135.60	136.96	138.31	139.67	141.02	142.38	143.74	145.09	146.45	147.80

## Döndürme Momenti Dönüşüm Tablosu Conversion Table For Bending Moments

Var Olan Ölçüler/ present units	İstenen Ölçüler / Wanted Units					
	=Ncm	=Nm	=kpcm	=kpm	=lbf.in.	=lbf.ft.
Ncm	1	0.01	0.10197	0.00102	0.0885	0.00738
Nm	100	1	10.197	0.10197	8.851	0.7376
kpcm	9.807	0.09807	1	0.01	0.868	0.0723
kpm	980.07	9.807	100	1	86.796	7.233
lbf.in.	11.298	0.11298	1.152	0.01152	1	0.0833
lbf.ft.	135.58	1.3558	13.825	0.13825	12	1

## Newton-Metre ve Kilopound-Metre Dönüşüm Tablosu Conversion Table Of Newton-Meter and Kilopound-Meter (1 Nm=0.102 kpm)

Nm	kpm									
	0	1	2	3	4	5	6	7	8	9
0	0.00	1.02	2.04	3.06	4.08	5.10	6.12	7.14	8.16	9.18
100	10.20	11.22	12.24	13.26	14.28	15.30	16.31	17.33	18.35	19.37
200	20.39	21.41	22.43	23.45	24.47	25.49	26.51	27.53	28.55	29.57
300	30.59	31.61	32.63	33.65	34.67	35.69	36.71	37.73	38.75	39.77
400	40.79	41.81	42.83	43.85	44.87	45.89	46.91	47.93	48.95	49.97
500	50.99	52.00	53.02	54.04	55.06	56.08	57.10	58.12	59.14	60.16
600	61.18	62.20	63.22	64.24	65.26	66.28	67.30	68.32	69.34	70.36
700	71.38	72.40	73.42	74.44	75.46	76.48	77.50	78.52	79.54	80.56
800	81.58	82.60	83.62	84.64	85.66	86.68	87.70	88.71	89.73	90.75
900	91.77	92.79	93.81	94.83	95.85	96.87	97.89	98.91	99.93	100.95
1000	101.97	102.99	104.01	105.03	106.05	107.07	108.09	109.11	110.13	111.15



## Sertlik Dönüşüm Tablosu

### Hardness Conversion Table

Vickers Sertlik Hardness	Brinell Sertlik Hardness	Rockwell Sertlik Hardness		Çekme dayanımı Tensile Strength
HV 30	HB 30	HRB	HRC	sB N/mm2
80	80.7	36.4	-	270
85	85	42.4	-	290
90	90	47.4	-	310
95	95	52.00	-	320
100	100	56.4	-	340
105	105	60.0	-	360
110	110	63.4	-	380
115	115	66.4	-	390
120	120	69.4	-	410
125	125	72.0	-	420
130	130	74.4	-	440
135	135	76.4	-	460
140	140	78.4	-	470
145	145	80.4	-	490
150	150	82.2	-	500
155	155	83.8	-	520
160	160	85.4	-	540
165	165	86.8	-	550
170	170	88.2	-	570
175	175	89.6	-	590
180	180	90.8	-	600
185	185	91.8	-	620
195	190	91.5	-	640
200	195	94.0	-	660
200	200	95.0	-	670
205	205	95.8	-	680
210	210	96.6	-	710
215	215	97.4	-	720
220	220	98.2	-	730
225	225	99.0	-	750
230	230	-	19.2	760
235	235	-	20.2	780
240	240	-	21.2	800
245	245	-	22.1	820
250	250	-	23.0	830
255	255	-	23.8	850
260	260	-	24.6	870
265	265	-	25.4	880
280	280	-	27.1	900
275	275	-	26.9	920
280	280	-	27.6	940
285	285	-	28.3	950
290	290	-	29.0	970
295	295	-	29.6	990
300	300	-	30.3	1010
310	310	-	31.5	1040
320	320	-	32.7	1080
330	330	-	33.8	1110

Vickers Sertlik Hardness	Brinell Sertlik Hardness	Rockwell Sertlik Hardness		Çekme dayanımı Tensile Strength
HV 30	HB 30	HRB	HRC	sB N/mm2
340	340	-	34.9	1140
350	350	-	36.0	1170
360	359	-	37.0	1200
370	368	-	38.0	1260
380	376	-	38.9	1260
390	385	-	39.8	1290
400	392	-	40.7	1320
410	400	-	41.5	1350
420	408	-	42.4	1380
440	423	-	44.0	1430
450	430	-	44.8	1460
460	-	-	45.6	-
470	-	-	46.3	-
480	-	-	47.0	-
490	-	-	47.7	-
500	-	-	48.3	-
510	-	-	49.1	-
520	-	-	49.7	-
530	-	-	50.4	-
540	-	-	51.0	-
550	-	-	51.6	-
560	-	-	52.2	-
570	-	-	52.8	-
580	-	-	53.3	-
590	-	-	53.9	-
600	-	-	54.4	-
610	-	-	55.0	-
620	-	-	55.5	-
630	-	-	56.0	-
640	-	-	56.5	-
650	-	-	57.0	-
660	-	-	57.5	-
670	-	-	58.0	-
680	-	-	58.5	-
690	-	-	59.0	-
700	-	-	59.5	-
720	-	-	60.4	-
740	-	-	61.2	-
760	-	-	62.0	-
780	-	-	62.8	-
800	-	-	63.6	-
820	-	-	64.3	-
840	-	-	65.0	-
860	-	-	65.7	-
880	-	-	66.3	-
900	-	-	66.9	-
920	-	-	67.5	-
940	-	-	68.0	-

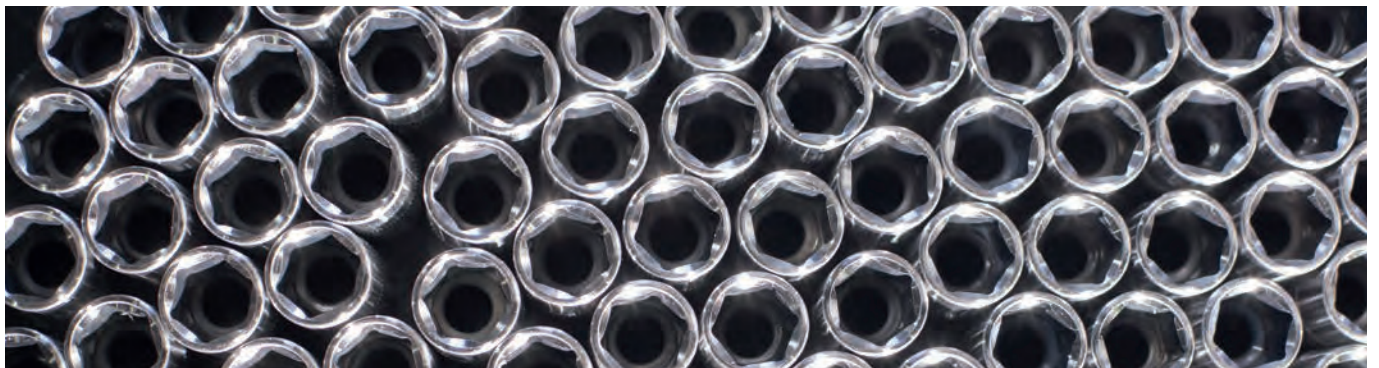

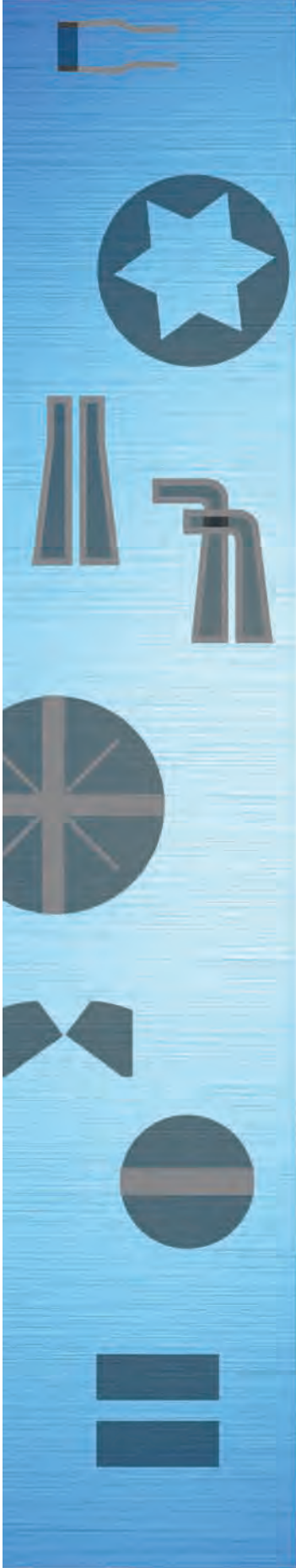
**Semboller / Symbols**

**Anahtar Ağız  
Size**



**Ağız Açıklığı  
Opening Limit of Jaws**



**Altı Köşe Lokma Bijon  
Anahtar Ağız  
Six Point Sockets**



**Sekiz Köşe Anahtar Ağız  
Eight Point Wrench**



**On iki Köşe Anahtar Ağız  
Twelve Point Wrench**



**Kare Adaptör  
Square Adapter**



**Kovan Anahtar  
Tubular Socket Wrench**



**Bir Ağız Bijon Anahtar  
Single Ended Rim Wrench**



**TORX® Lokma Anahtar  
TORX Socket**



**Düz Uç  
Flat Tip**



**Yıldız Uç  
PHILLIPS® Tip**



**POZIDRIV® Yıldız Uç  
POZIDRIV® Tip**



**TORX® Uç  
TORX® Tip**



**Delikli TORX® Uç  
TORX® with hole**



**Bits Tutucular  
Bit Holders**



**Allen Anahtar  
Hexagonal Allen Keys**



**Segman  
Circlip**



**Gövde Ağırlık  
Weight of Body**



**Tapa Anahtar  
Wrench for Carter Case**



**İşkençe  
Screw Clamp**



**Çektirme  
Puller**

in.	dec.in.	millimeters (mm)													
		0"	1"	2"	3"	4"	5"	6"	7"	8"	9"	10"	11"		
0	0	0	25.400 0	50.800 0	76.200 0	101.600 0	127.000 0	152.400 0	177.800 0	203.200 0	228.600 0	254.000 0	279.400 0	304.800 0	
1/64	0.015 625	0.396 9	25.796 9	51.196 9	76.596 9	101.996 9	127.396 9	152.796 9	178.196 9	203.596 9	228.996 9	254.396 9	279.796 9	305.196 9	
1/32	0.031 25	0.793 8	26.193 8	51.593 8	76.993 8	102.393 8	127.793 8	153.193 8	178.593 8	203.993 8	229.393 8	254.793 8	280.193 8	305.593 8	
3/64	0.046 875	1.190 6	26.590 6	51.990 6	77.390 6	102.790 6	128.190 6	153.590 6	178.990 6	204.390 6	229.790 6	255.190 6	280.590 6	306.390 6	
1/16	0.062 5	1.587 5	26.987 5	52.387 5	77.787 5	103.187 5	128.587 5	153.987 5	179.387 5	204.787 5	230.187 5	255.587 5	280.987 5	306.787 5	
5/64	0.078 125	1.984 4	27.384 4	52.784 4	78.184 4	103.584 4	128.984 4	154.384 4	179.784 4	205.184 4	230.584 4	255.984 4	281.384 4	307.184 4	
3/32	0.093 75	2.381 2	27.781 2	53.181 2	78.581 2	103.981 2	129.381 2	154.781 2	180.181 2	205.581 2	230.981 2	256.381 2	281.781 2	307.581 2	
7/64	0.109 375	2.778 1	28.178 1	53.578 1	78.978 1	104.378 1	129.778 1	155.178 1	180.578 1	205.978 1	231.378 1	256.778 1	282.178 1	307.978 1	
1/8	0.125	3.175 0	28.575 0	53.975 0	79.375 0	104.775 0	130.175 0	155.575 0	180.975 0	206.375 0	231.775 0	257.175 0	282.575 0	308.375 0	
9/64	0.140 625	3.571 9	28.971 9	54.371 9	79.771 9	105.171 9	130.571 9	155.971 9	181.371 9	206.771 9	232.171 9	257.571 9	282.971 9	308.771 9	
5/32	0.156 25	3.968 8	29.368 8	54.768 8	80.168 8	105.568 8	130.968 8	156.368 8	181.768 8	207.168 8	232.568 8	257.968 8	283.368 8	309.168 8	
11/64	0.171 875	4.365 6	29.765 6	55.165 6	80.565 6	105.965 6	131.365 6	156.765 6	182.165 6	207.565 6	232.965 6	258.365 6	283.765 6	309.565 6	
3/16	0.187 5	4.762 5	30.162 5	55.562 5	80.962 5	106.362 5	131.762 5	157.162 5	182.562 5	207.962 5	233.362 5	258.762 5	284.162 5	309.962 5	
13/64	0.203 125	5.159 4	30.559 4	55.959 4	81.359 4	106.759 4	132.159 4	157.559 4	182.959 4	208.359 4	233.759 4	259.159 4	284.559 4	310.359 4	
7/32	0.218 75	5.556 2	30.956 2	56.356 2	81.756 2	107.156 2	132.556 2	157.956 2	183.356 2	208.756 2	234.156 2	259.556 2	284.956 2	310.756 2	
15/64	0.234 375	5.953 1	31.353 1	56.753 1	82.153 1	107.553 1	132.953 1	158.353 1	183.753 1	209.153 1	234.553 1	259.953 1	285.353 1	311.153 1	
1/4	0.25	6.350 0	31.750 0	57.150 0	82.550 0	107.950 0	133.350 0	158.750 0	184.150 0	209.550 0	234.950 0	260.350 0	285.750 0	311.550 0	
17/64	0.265 625	6.746 9	32.146 9	57.546 9	82.946 9	108.346 9	133.746 9	159.146 9	184.546 9	209.946 9	235.346 9	260.746 9	286.146 9	311.946 9	
9/32	0.281 25	7.143 8	32.543 8	57.943 8	83.343 8	108.743 8	134.143 8	159.543 8	184.943 8	210.343 8	235.743 8	261.143 8	286.543 8	312.343 8	
19/64	0.296 875	7.540 6	32.940 6	58.340 6	83.740 6	109.140 6	134.540 6	159.940 6	185.340 6	210.740 6	236.140 6	261.540 6	286.940 6	312.740 6	
5/16	0.312 5	7.937 5	33.337 5	58.737 5	84.137 5	109.537 5	134.937 5	160.337 5	185.737 5	211.137 5	236.537 5	261.937 5	287.337 5	313.137 5	
21/64	0.328 125	8.334 4	33.734 4	59.134 4	84.534 4	109.934 4	135.334 4	160.734 4	186.134 4	211.534 4	236.934 4	262.334 4	287.734 4	313.534 4	
11/32	0.343 75	8.731 2	34.131 2	59.531 2	84.931 2	110.331 2	135.731 2	161.131 2	186.531 2	211.931 2	237.331 2	262.731 2	288.131 2	313.931 2	
23/64	0.359 375	9.128 1	34.528 1	59.928 1	85.328 1	110.728 1	136.128 1	161.528 1	186.928 1	212.328 1	237.728 1	263.128 1	288.528 1	314.328 1	
3/8	0.375	9.525 0	34.925 0	60.325 0	85.725 0	111.125 0	136.525 0	161.925 0	187.325 0	212.725 0	238.125 0	263.525 0	288.925 0	314.725 0	
25/64	0.390 625	9.921 9	35.321 9	60.721 9	86.121 9	111.521 9	136.921 9	162.321 9	187.721 9	213.121 9	238.521 9	263.921 9	289.321 9	315.121 9	
13/32	0.406 25	10.318 8	35.718 8	61.118 8	86.518 8	111.918 8	137.318 8	162.718 8	188.118 8	213.518 8	238.918 8	264.318 8	289.718 8	315.518 8	
27/64	0.421 875	10.715 6	36.115 6	61.515 6	86.915 6	112.315 6	137.715 6	163.115 6	188.515 6	213.915 6	239.315 6	264.715 6	290.115 6	315.915 6	
7/16	0.437 5	11.112 5	36.512 5	61.912 5	87.312 5	112.712 5	138.112 5	163.512 5	188.912 5	214.312 5	239.712 5	265.112 5	290.512 5	316.312 5	
29/64	0.453 125	11.509 4	36.909 4	62.309 4	87.709 4	113.109 4	138.509 4	163.909 4	189.309 4	214.709 4	240.109 4	265.509 4	290.909 4	316.709 4	
15/32	0.468 75	11.906 2	37.306 2	62.706 2	88.106 2	113.506 2	138.906 2	164.306 2	189.706 2	215.106 2	240.506 2	265.906 2	291.306 2	317.106 2	
31/64	0.484 375	12.303 1	37.703 1	63.103 1	88.503 1	113.903 1	139.303 1	164.703 1	190.103 1	215.503 1	240.903 1	266.303 1	291.703 1	317.503 1	
1/2	0.5	12.700 0	38.100 0	63.500 0	88.900 0	114.300 0	139.700 0	165.100 0	190.500 0	215.900 0	241.300 0	266.700 0	292.100 0	317.900 0	
33/64	0.515 625	13.096 9	38.496 9	63.896 9	89.296 9	114.696 9	140.096 9	165.496 9	190.896 9	216.296 9	241.696 9	267.096 9	292.496 9	318.296 9	
17/32	0.531 25	13.493 8	38.893 8	64.293 8	89.693 8	115.093 8	140.493 8	165.893 8	191.293 8	216.693 8	242.093 8	267.493 8	292.893 8	318.693 8	
35/64	0.546 875	13.890 6	39.290 6	64.690 6	90.090 6	115.490 6	140.890 6	166.290 6	191.690 6	217.090 6	242.490 6	267.890 6	293.290 6	319.090 6	
9/16	0.562 5	14.287 5	39.687 5	65.087 5	90.487 5	115.887 5	141.287 5	166.687 5	192.087 5	217.487 5	242.887 5	268.287 5	293.687 5	319.487 5	
37/64	0.578 125	14.684 4	40.084 4	65.484 4	90.884 4	116.284 4	141.684 4	167.084 4	192.484 4	217.884 4	243.284 4	268.684 4	294.084 4	319.884 4	
19/32	0.593 75	15.081 2	40.481 2	65.881 2	91.281 2	116.681 2	142.081 2	167.481 2	192.881 2	218.281 2	243.681 2	269.081 2	294.481 2	320.281 2	
39/64	0.609 375	15.478 1	40.878 1	66.278 1	91.678 1	117.078 1	142.478 1	167.878 1	193.278 1	218.678 1	244.078 1	269.478 1	294.878 1	320.678 1	
5/8	0.625	15.875 0	41.275 0	66.675 0	92.075 0	117.475 0	142.875 0	168.275 0	193.675 0	219.075 0	244.475 0	269.875 0	295.275 0	321.075 0	
41/64	0.640 625	16.271 9	41.671 9	67.071 9	92.471 9	117.871 9	143.271 9	168.671 9	194.071 9	219.471 9	244.871 9	270.271 9	295.671 9	321.471 9	
21/32	0.656 25	16.668 8	42.068 8	67.468 8	92.868 8	118.268 8	143.668 8	169.068 8	194.468 8	219.868 8	245.268 8	270.668 8	296.068 8	321.868 8	
43/64	0.671 875	17.065 6	42.465 6	67.865 6	93.265 6	118.665 6	144.065 6	169.465 6	194.865 6	220.265 6	245.665 6	271.065 6	296.465 6	322.265 6	
11/16	0.687 5	17.462 5	42.862 5	68.262 5	93.662 5	119.062 5	144.462 5	169.862 5	195.262 5	220.662 5	246.062 5	271.462 5	296.862 5	322.662 5	
45/64	0.703 125	17.859 4	43.259 4	68.659 4	94.059 4	119.459 4	144.859 4	170.259 4	195.659 4	221.059 4	246.459 4	271.859 4	297.259 4	323.059 4	
23/32	0.718 75	18.256 2	43.656 2	69.056 2	94.456 2	119.856 2	145.256 2	170.656 2	196.056 2	221.456 2	246.856 2	272.256 2	297.656 2	323.456 2	
47/64	0.734 375	18.653 1	44.053 1	69.453 1	94.853 1	120.253 1	145.653 1	171.053 1	196.453 1	221.853 1	247.253 1	272.653 1	298.053 1	323.853 1	
3/4	0.75	19.050 0	44.450 0	69.850 0	95.250 0	120.650 0	146.050 0	171.450 0	196.850 0	222.250 0	247.650 0	273.050 0	298.450 0	324.250 0	
49/64	0.765 625	19.446 9	44.846 9	70.246 9	95.646 9	121.046 9	146.446 9	171.846 9	197.246 9	222.646 9	248.046 9	273.446 9	298.846 9	324.646 9	
25/32	0.781 25	19.843 8	45.243 8	70.643 8	96.043 8	121.443 8	146.843 8	172.243 8	197.643 8	223.043 8	248.443 8	273.843 8	299.243 8	325.043 8	
51/64	0.796 875	20.240 6	45.640 6	71.040 6	96.440 6	121.840 6	147.240 6	172.640 6	198.040 6	223.440 6	248.840 6	274.240 6	299.640 6	325.440 6	
13/16	0.812 5	20.637 5	46.037 5	71.437 5	96.837 5	122.237 5	147.637 5	173.037 5	198.437 5	223.837 5	249.237 5	274.637 5	300.037 5	325.837 5	
53/64	0.828 125	21.034 4	46.434 4	71.834 4	97.234 4	122.634 4	148.034 4	173.434 4	198.834 4	224.234 4	249.634 4	275.034 4	300.434 4	326.234 4	
27/32	0.843 75	21.431 2	46.831 2	72.231 2	97.631 2	123.031 2	148.431 2	173.831 2	199.231 2	224.631 2	250.031 2	275.431 2	300.831 2	326.631 2	
55/64	0.859 375	21.828 1	47.228 1	72.628 1	98.028 1	123.428 1	148.828 1	174.228 1	199.628 1	225.028 1	250.428 1	275.828 1	301.228 1	327.028 1	
7/8	0.875	22.225 0	47.625 0	73.025 0	98.425 0	123.825 0	149.225 0	174.625 0	200.025 0	225.425 0	250.825 0	276.225 0	301.625 0	327.425 0	
57/64	0.890 625	22.621 9	48.021 9	73.421 9	98.821 9	124.221 9	149.621 9	175.021 9	200.421 9	225.821 9	251.221 9	276.621 9	302.021 9	327.821 9	
29/32	0.906 25	23.018 8	48.418 8	73.818 8	99.218 8	124.618 8	150.018 8	175.418 8	200.818 8	226.218 8	251.618 8	277.018 8	302.418 8	328.218 8	
59/64															

**KALİTE GÜVENCE TESTLERİ / QUALITY ASSURANCE TEST**

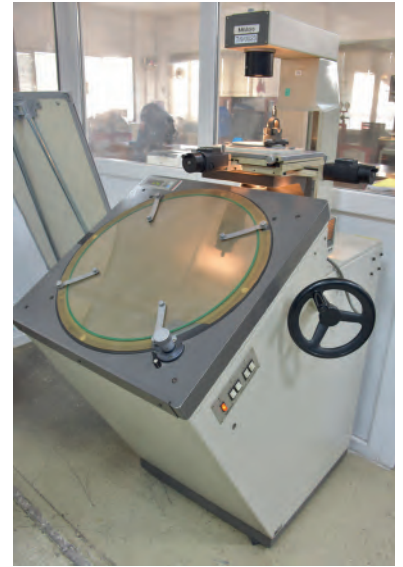
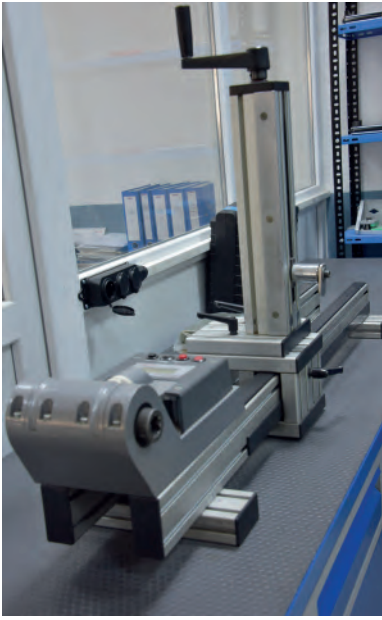



## YASAL UYARILAR / LEGAL NOTIE

Bu katalog, önceki baskıların yerine geçer. Katalog içerisinde yer alan ürünlerin teknik özellikleri, görünümü, ölçüleri katalogun yayınlandığı tarihteki mevcut şartları temsil etmektedir. Bu sebeple sipariş verilmeden önce mutlaka firma ile iletişime geçerek sipariş tarihindeki ürünlere ilişkin güncel bilgileri öğrenmenizi öneririz. Katalogta belirtilen ürünlere ait teknik özellikler, görünüm veya ölçü gibi özelliklerin sipariş tarihindeki ürünler ile aynı olmamasından kaynaklı firmanın her ne nam altında olursa olsun hiçbir sorumluluğu bulunmamaktadır. Bu bilgiler doğrultusunda, firma işbu katalog içeriğinde yer alan bilgilerden veya görsel malzemeden kaynaklanabilecek hatalardan, maddi veya manevi zararlardan hiç bir şekil ve surette sorumlu değildir.

Firma katalog içeriğinde yer alan bilgiler veya ürünler ile ilgili önceden haber vermeksizin tek taraflı değişiklikler yapabilir. Firma dilediği zaman, ürünlerinin teknik özelliklerini, görsellerini veya ölçülerini veya ürünlerini tamamen veya kısmen değiştirme hakkına sahiptir. Kataloglarda yer alan görsellerde gözüken montaj, bağlantı detayları, kullanım alanları veya güvenlik önlemleri ürünlerin doğru kullanımı için bir örnek teşkil etmez. Ürünleri kullanan kişiler, katalog içeriğinde yer alan ürünler ile ilgili güvenlik uyarılarına ve ayrıca ürünlere ilişkin ek güvenlik/kullanım talimatlarına uymakla yükümlüdür, aksi takdirde ortaya çıkacak zararlardan firma hiçbir suretle sorumlu tutulamaz.

İşbu Katalog, tüm sayfaları, içeriğindeki bilgiler ve ürünler firmanın fikri ve sınai hakları kapsamında korunmaktadır. Ürün katalogu, içeriğindeki tüm bilgiler ile görseller ve ürünlere ilişkin telif hakkı İzeltaş İzmir El Aletleri Sanayi ve Ticaret A.Ş.'ye aittir. Firmanın yazılı izni olmadan işbu telif hakkına konu ürünlerin, bilgilerin, görsellerin veya katalogun izinsiz kullanılması, yayımlanması, üretilmesi, dağıtılması ve çoğaltılması yasaktır, aksi durum firmanın fikri ve sınai hakkın ihlali sonucunu doğuracaktır.

*This catalog replaces previous editions.*

*The technical features, appearance and dimensions of the products in the catalog represent the current conditions at the date of publication of the catalog. For this reason, we recommend that you contact the company before ordering and learn the current information about the products on the order date. The company does not have any responsibility under any name due to the fact that the technical features, appearance or size of the products specified in the catalog are not the same as the products on the order date. In line with this information, the company is not responsible in any way or form for any errors, material or moral damages that may arise from the information or visual material contained in this catalogue.*

*The company may make unilateral changes regarding the information or products in the catalog without prior notice. The company reserves the right to change the technical specifications, images or dimensions of its products or products, in whole or in part, at any time. The assembly, connection details, usage areas or safety measures seen in the images in the catalogs do not constitute an example for the correct use of the products. Persons using the products are obliged to comply with the safety warnings regarding the products in the catalog content, as well as the additional safety / usage instructions regarding the products, otherwise the company cannot be held responsible for any damages that may arise.*

*This Catalog, all its pages, the information and products in it are protected within the scope of the intellectual and industrial rights of the company. The copyright of the product catalog, all the information in its content, images and products belongs to İzeltaş İzmir El Aletleri Sanayi ve Ticaret A.Ş. Unauthorized use, publication, production, distribution and reproduction of the products, information, images or catalog subject to this copyright without the written permission of the company is prohibited, otherwise it will result in violation of the intellectual and industrial rights of the company.*



KOD	ÜRÜN	FİYAT	SAYFA	KOD	ÜRÜN	FİYAT	SAYFA
1225060036	1" 12KŞ LKM ANH 36	419,00	91	1413061022	1/2" 12KŞ LKM ANH 7/8 SAE	76,75	81
1225060041	1" 12KŞ LKM ANH 41	456,00	91	1413061013	1/2" 12KŞ LKM ANH 9/16 SAE	70,25	81
1225060046	1" 12KŞ LKM ANH 46	553,00	91	1114006024	1/2" 12KŞ LKM ANH SET24	2.255,00	87
1225060050	1" 12KŞ LKM ANH 50	655,00	91	1413006024	1/2" 12KŞ LKM ANH SET24 SAE	2.478,00	87
1225060055	1" 12KŞ LKM ANH 55	838,75	91	1114064210	1/2" 12KŞ LKM BİTS XZN M10 140	108,50	84
1225060060	1" 12KŞ LKM ANH 60	1.090,25	91	1114064010	1/2" 12KŞ LKM BİTS XZN M10 60	62,50	84
1125067024	1" 6KŞ HVL LKM ANH 24	372,25	94	1114064110	1/2" 12KŞ LKM BİTS XZN M10 80	87,00	84
1125067027	1" 6KŞ HVL LKM ANH 27	375,50	94	1114064212	1/2" 12KŞ LKM BİTS XZN M12 140	122,25	84
1125067030	1" 6KŞ HVL LKM ANH 30	378,75	94	1114064012	1/2" 12KŞ LKM BİTS XZN M12 60	74,25	84
1125067032	1" 6KŞ HVL LKM ANH 32	383,25	94	1114064112	1/2" 12KŞ LKM BİTS XZN M12 80	90,00	84
1125067033	1" 6KŞ HVL LKM ANH 33	383,25	94	1114064214	1/2" 12KŞ LKM BİTS XZN M14 140	137,25	84
1125067034	1" 6KŞ HVL LKM ANH 34	385,25	94	1114064114	1/2" 12KŞ LKM BİTS XZN M14 80	96,25	84
1125067036	1" 6KŞ HVL LKM ANH 36	387,00	94	1114064216	1/2" 12KŞ LKM BİTS XZN M16 140	199,00	84
1125067038	1" 6KŞ HVL LKM ANH 38	403,00	94	1114064005	1/2" 12KŞ LKM BİTS XZN M5 60	62,50	84
1125067041	1" 6KŞ HVL LKM ANH 41	491,00	94	1114064006	1/2" 12KŞ LKM BİTS XZN M6 60	62,50	84
1125067046	1" 6KŞ HVL LKM ANH 46	541,75	94	1114064106	1/2" 12KŞ LKM BİTS XZN M6 80	79,00	84
1125067050	1" 6KŞ HVL LKM ANH 50	577,75	94	1114064208	1/2" 12KŞ LKM BİTS XZN M8 140	88,50	84
1125067055	1" 6KŞ HVL LKM ANH 55	766,00	94	1114064008	1/2" 12KŞ LKM BİTS XZN M8 60	62,50	84
1125067060	1" 6KŞ HVL LKM ANH 60	957,50	94	1114064108	1/2" 12KŞ LKM BİTS XZN M8 80	79,00	84
1525067175	1" HVL LKM ARA KOL 175	929,00	94	1108060010	1/2" 6KŞ DRN LKM ANH 10	100,75	82
1525067250	1" HVL LKM ARA KOL 250	1.193,75	94	1108060011	1/2" 6KŞ DRN LKM ANH 11	100,75	82
1525067330	1" HVL LKM ARA KOL 330	1.451,25	94	1108060012	1/2" 6KŞ DRN LKM ANH 12	100,75	82
1525067128	1" HVL LKM MFSL 128	1.732,25	94	1108060013	1/2" 6KŞ DRN LKM ANH 13	108,00	82
2201100010	1" MŞL BORU ANH 85	422,00	101	1108060014	1/2" 6KŞ DRN LKM ANH 14	108,00	82
2203100010	1" MŞL BORU ANH 85 ELTA	352,00	195	1108060015	1/2" 6KŞ DRN LKM ANH 15	108,00	82
2201100110	1" MŞL BORU ANH YP SMN 85	21,50	202	1108060016	1/2" 6KŞ DRN LKM ANH 16	113,00	82
1525067015	1"FX3/4" M HVL LKM ADP	355,50	94	1108060017	1/2" 6KŞ DRN LKM ANH 17	113,00	82
1525060005	1"FX3/4" M LKM ADP	269,50	91	1108060018	1/2" 6KŞ DRN LKM ANH 18	113,00	82
1413061025	1/2" 12KŞ LKM ANH 1 SAE	80,00	81	1108060019	1/2" 6KŞ DRN LKM ANH 19	118,25	82
1413061012	1/2" 12KŞ LKM ANH 1/2 SAE	68,00	81	1108060010	1/2" 6KŞ DRN LKM TK10	1.083,50	82
1114061010	1/2" 12KŞ LKM ANH 10	54,00	81	1108067010	1/2" 6KŞ HVL DRN LKM ANH 10	117,00	92
1114061011	1/2" 12KŞ LKM ANH 11	54,00	81	1108067011	1/2" 6KŞ HVL DRN LKM ANH 11	117,00	92
1413061016	1/2" 12KŞ LKM ANH 11/16 SAE	73,50	81	1108067012	1/2" 6KŞ HVL DRN LKM ANH 12	117,00	92
1413061027	1/2" 12KŞ LKM ANH 1-1/16 SAE	105,00	81	1108067013	1/2" 6KŞ HVL DRN LKM ANH 13	127,00	92
1413061032	1/2" 12KŞ LKM ANH 1-1/4 SAE	105,00	81	1108067014	1/2" 6KŞ HVL DRN LKM ANH 14	127,00	92
1413061029	1/2" 12KŞ LKM ANH 1-1/8 SAE	105,00	81	1114061030	1/2" 12KŞ LKM ANH 34	141,75	92
1114061012	1/2" 12KŞ LKM ANH 12	54,00	81	1108067016	1/2" 6KŞ HVL DRN LKM ANH 16	141,75	92
1114061013	1/2" 12KŞ LKM ANH 13	58,25	81	1108067017	1/2" 6KŞ HVL DRN LKM ANH 17	141,75	92
1413061021	1/2" 12KŞ LKM ANH 13/16 SAE	76,75	81	1108067018	1/2" 6KŞ HVL DRN LKM ANH 18	141,75	92
1413061030	1/2" 12KŞ LKM ANH 1-3/16 SAE	105,00	81	1108067019	1/2" 6KŞ HVL DRN LKM ANH 19	141,75	92
1114061014	1/2" 12KŞ LKM ANH 14	58,25	81	1108067021	1/2" 6KŞ HVL DRN LKM ANH 21	148,00	92
1114061015	1/2" 12KŞ LKM ANH 15	58,25	81	1108067022	1/2" 6KŞ HVL DRN LKM ANH 22	148,00	92
1413061024	1/2" 12KŞ LKM ANH 15/16 SAE	80,00	81	1108067024	1/2" 6KŞ HVL DRN LKM ANH 24	156,25	92
1413061011	1/2" 12KŞ LKM ANH 15/32 SAE	65,25	81	1108067027	1/2" 6KŞ HVL DRN LKM ANH 27	206,75	92
1114061016	1/2" 12KŞ LKM ANH 16	60,75	81	1108067030	1/2" 6KŞ HVL DRN LKM ANH 30	231,75	92
1114061017	1/2" 12KŞ LKM ANH 17	60,75	81	1108067032	1/2" 6KŞ HVL DRN LKM ANH 32	247,00	92
1114061018	1/2" 12KŞ LKM ANH 18	60,75	81	1113067010	1/2" 6KŞ HVL LKM ANH 10	61,50	92
1114061019	1/2" 12KŞ LKM ANH 19	63,75	81	1113067011	1/2" 6KŞ HVL LKM ANH 11	61,50	92
1413061014	1/2" 12KŞ LKM ANH 19/32 SAE	70,25	81	1113067012	1/2" 6KŞ HVL LKM ANH 12	61,50	92
1114061020	1/2" 12KŞ LKM ANH 20	63,75	81	1113067013	1/2" 6KŞ HVL LKM ANH 13	65,75	92
1114061021	1/2" 12KŞ LKM ANH 21	63,75	81	1113067014	1/2" 6KŞ HVL LKM ANH 14	65,75	92
1114061022	1/2" 12KŞ LKM ANH 22	63,75	81	1113067015	1/2" 6KŞ HVL LKM ANH 15	75,75	92
1114061023	1/2" 12KŞ LKM ANH 23	66,25	81	1113067016	1/2" 6KŞ HVL LKM ANH 16	79,25	92
1114061024	1/2" 12KŞ LKM ANH 24	66,25	81	1113067017	1/2" 6KŞ HVL LKM ANH 17	79,50	92
1413061020	1/2" 12KŞ LKM ANH 25/32 SAE	76,75	81	1113067018	1/2" 6KŞ HVL LKM ANH 18	79,75	92
1114061026	1/2" 12KŞ LKM ANH 26	74,50	81	1113067019	1/2" 6KŞ HVL LKM ANH 19	81,25	92
1114061027	1/2" 12KŞ LKM ANH 27	85,25	81	1113067021	1/2" 6KŞ HVL LKM ANH 21	85,50	92
1114061028	1/2" 12KŞ LKM ANH 28	85,25	81	1113067022	1/2" 6KŞ HVL LKM ANH 22	88,25	92
1413061017	1/2" 12KŞ LKM ANH 3/4 SAE	74,25	81	1113067024	1/2" 6KŞ HVL LKM ANH 24	101,25	92
1413061095	1/2" 12KŞ LKM ANH 3/8 SAE	63,00	81	1113067027	1/2" 6KŞ HVL LKM ANH 27	128,75	92
1114061030	1/2" 12KŞ LKM ANH 30	89,50	81	1113009003	1/2" 6KŞ JNT LKM ANH TK3	705,75	91
1114061032	1/2" 12KŞ LKM ANH 32	93,75	81	1113061008	1/2" 6KŞ LKM ANH 08	43,25	80
1413061008	1/2" 12KŞ LKM ANH 5/16 SAE	63,00	81	1113061009	1/2" 6KŞ LKM ANH 09	43,25	80
1413061015	1/2" 12KŞ LKM ANH 5/8 SAE	71,00	81	1113061010	1/2" 6KŞ LKM ANH 10	53,75	80
1413061010	1/2" 12KŞ LKM ANH 7/16 SAE	65,25	81	1115060010	1/2" 6KŞ LKM ANH 10 ELTA	43,75	193

KOD	ÜRÜN	FİYAT	SAYFA	KOD	ÜRÜN	FİYAT	SAYFA
1113061011	1/2" 6KŞ LKM ANH 11	53,75	80	1113065010	1/2" BITS TUTC LKM	60,50	85
1115060011	1/2" 6KŞ LKM ANH 11 ELTA	43,75	193	1113069160	1/2" BUJİ LKM LSTK 16	77,75	81
1113061012	1/2" 6KŞ LKM ANH 12	53,75	80	1113069208	1/2" BUJİ LKM LSTK 20,8	100,25	81
1115060012	1/2" 6KŞ LKM ANH 12 ELTA	43,75	193	1514065250	1/2" CRC KOL 250 ELTA	357,50	194
1113061013	1/2" 6KŞ LKM ANH 13	57,75	80	1513060032	1/2" CRC KOL 32DİŞ 250	448,25	84
1115060013	1/2" 6KŞ LKM ANH 13 ELTA	45,50	193	1613064020	1/2" CRC TORK ANH 40-200NM	3.888,50	97
1113061014	1/2" 6KŞ LKM ANH 14	57,75	80	1613066034	1/2" CRC TORK ANH 60-340NM	4.076,75	97
1115060014	1/2" 6KŞ LKM ANH 14 ELTA	45,50	193	1513067125	1/2" HVL LKM ARA KOL 125	233,50	92
1113061015	1/2" 6KŞ LKM ANH 15	57,75	80	1513067075	1/2" HVL LKM MFSL 75	296,50	92
1115060015	1/2" 6KŞ LKM ANH 15 ELTA	45,50	193	1113316100	1/2" LKM ANH SHP	1.121,00	208
1113061016	1/2" 6KŞ LKM ANH 16	60,50	80	1113006145	1/2" LKM ANH&SHP SET146	10.098,50	80
1115060016	1/2" 6KŞ LKM ANH 16 ELTA	47,25	193	1114065010	1/2" LKM BITS UÇ RİBE M10	86,75	84
1113061017	1/2" 6KŞ LKM ANH 17	60,50	80	1114065011	1/2" LKM BITS UÇ RİBE M10,5	88,75	84
1115060017	1/2" 6KŞ LKM ANH 17 ELTA	47,25	193	1114065012	1/2" LKM BITS UÇ RİBE M12	110,50	84
1113061018	1/2" 6KŞ LKM ANH 18	60,50	80	1114065013	1/2" LKM BITS UÇ RİBE M13	121,25	84
1115060018	1/2" 6KŞ LKM ANH 18 ELTA	47,25	193	1114065014	1/2" LKM BITS UÇ RİBE M14	121,25	84
1113061019	1/2" 6KŞ LKM ANH 19	63,25	80	1114065016	1/2" LKM BITS UÇ RİBE M16	164,00	84
1115060019	1/2" 6KŞ LKM ANH 19 ELTA	50,75	193	1114065004	1/2" LKM BITS UÇ RİBE M4	86,00	84
1113061020	1/2" 6KŞ LKM ANH 20	63,25	80	1114065005	1/2" LKM BITS UÇ RİBE M5	86,00	84
1115060020	1/2" 6KŞ LKM ANH 20 ELTA	50,75	193	1114065006	1/2" LKM BITS UÇ RİBE M6	86,00	84
1113061021	1/2" 6KŞ LKM ANH 21	63,25	80	1114065007	1/2" LKM BITS UÇ RİBE M7	86,00	84
1115060021	1/2" 6KŞ LKM ANH 21 ELTA	50,75	193	1114065008	1/2" LKM BITS UÇ RİBE M8	86,00	84
1113061022	1/2" 6KŞ LKM ANH 22	63,25	80	1114065009	1/2" LKM BITS UÇ RİBE M9	86,75	84
1115060022	1/2" 6KŞ LKM ANH 22 ELTA	50,75	193	1514064065	1/2" MFSL 65 ELTA	117,00	193
1113061023	1/2" 6KŞ LKM ANH 23	65,75	80	1513064070	1/2" MFSL 70	144,00	85
1115060023	1/2" 6KŞ LKM ANH 23 ELTA	55,25	193	1840080500	1/2" MFSL T KOL 500	671,00	96
1113061024	1/2" 6KŞ LKM ANH 24	65,75	80	1513062250	1/2" T KOL 250	247,75	85
1115060024	1/2" 6KŞ LKM ANH 24 ELTA	55,25	193	1514064025	1/2" T KOL 250 ELTA	167,75	193
1113061025	1/2" 6KŞ LKM ANH 25	65,75	80	1513065250	1/2" T KOL LKM ADP	105,75	85
1113061026	1/2" 6KŞ LKM ANH 26	65,75	80	1514066250	1/2" T KOL LKM ADP ELTA	96,25	193
1115060026	1/2" 6KŞ LKM ANH 26 ELTA	62,00	193	1613061200	1/2" TORK ANH 25-135NM	3.965,75	97
1113061027	1/2" 6KŞ LKM ANH 27	75,50	80	1613062000	1/2" TORK ANH 50-225NM	4.093,50	97
1115060027	1/2" 6KŞ LKM ANH 27 ELTA	70,50	193	1613063000	1/2" TORK ANH 70-330NM	4.981,00	97
1113061028	1/2" 6KŞ LKM ANH 28	75,50	80	1113060210	1/2" TORX LKM ANH E10	51,75	82
1115060028	1/2" 6KŞ LKM ANH 28 ELTA	74,25	193	1113060212	1/2" TORX LKM ANH E12	51,75	82
1113061029	1/2" 6KŞ LKM ANH 29	79,50	80	1113060214	1/2" TORX LKM ANH E14	51,75	82
1113061030	1/2" 6KŞ LKM ANH 30	79,50	80	1113060216	1/2" TORX LKM ANH E16	51,75	82
1115060030	1/2" 6KŞ LKM ANH 30 ELTA	74,25	193	1113060218	1/2" TORX LKM ANH E18	51,75	82
1113061032	1/2" 6KŞ LKM ANH 32	82,75	80	1113060220	1/2" TORX LKM ANH E20	58,25	82
1115060032	1/2" 6KŞ LKM ANH 32 ELTA	79,50	193	1113006007	1/2" TORX LKM ANH SET7	430,50	82
1113002017	1/2" 6KŞ LKM ANH SET17	1.695,50	87	1113064220	1/2" TORX UÇ LKM ANH T20 100	96,25	83
1115002017	1/2" 6KŞ LKM ANH SET17 ELTA	1.419,25	194	1113061220	1/2" TORX UÇ LKM ANH T20 60--	85,00	83
1113002024	1/2" 6KŞ LKM ANH SET24	2.200,25	87	1113064225	1/2" TORX UÇ LKM ANH T25 100	96,25	83
1115002024	1/2" 6KŞ LKM ANH SET24 ELTA	1.844,00	194	1113061225	1/2" TORX UÇ LKM ANH T25 60	85,00	83
1975091322	1/2" ADP BİN ANH İSTV	328,50	96	1113064227	1/2" TORX UÇ LKM ANH T27 100	96,25	83
1113064105	1/2" ALLEN UÇ LKM ANH 05 100	81,50	83	1113061227	1/2" TORX UÇ LKM ANH T27 60	85,00	83
1113061105	1/2" ALLEN UÇ LKM ANH 05 60	69,00	83	1113064230	1/2" TORX UÇ LKM ANH T30 100	96,25	83
1113064106	1/2" ALLEN UÇ LKM ANH 06 100	81,50	83	1113061230	1/2" TORX UÇ LKM ANH T30 60	85,00	83
1113061106	1/2" ALLEN UÇ LKM ANH 06 60	69,00	83	1113064240	1/2" TORX UÇ LKM ANH T40 100	96,25	83
1113064107	1/2" ALLEN UÇ LKM ANH 07 100	81,50	83	1113061240	1/2" TORX UÇ LKM ANH T40 60	85,00	83
1113061107	1/2" ALLEN UÇ LKM ANH 07 60	69,00	83	1113064245	1/2" TORX UÇ LKM ANH T45 100	96,25	83
1113064108	1/2" ALLEN UÇ LKM ANH 08 100	81,50	83	1113061245	1/2" TORX UÇ LKM ANH T45 60	85,00	83
1113061108	1/2" ALLEN UÇ LKM ANH 08 60	69,00	83	1113064250	1/2" TORX UÇ LKM ANH T50 100	96,25	83
1113064110	1/2" ALLEN UÇ LKM ANH 10 100	94,25	83	1113061250	1/2" TORX UÇ LKM ANH T50 60	85,00	83
1113061110	1/2" ALLEN UÇ LKM ANH 10 60	78,75	83	1113064255	1/2" TORX UÇ LKM ANH T55 100	96,25	83
1113064112	1/2" ALLEN UÇ LKM ANH 12 100	94,25	83	1113061255	1/2" TORX UÇ LKM ANH T55 60	85,00	83
1113061112	1/2" ALLEN UÇ LKM ANH 12 60	78,75	83	1113064260	1/2" TORX UÇ LKM ANH T60 100	99,75	83
1113064114	1/2" ALLEN UÇ LKM ANH 14 100	113,50	83	1113061260	1/2" TORX UÇ LKM ANH T60 60	90,50	83
1113061114	1/2" ALLEN UÇ LKM ANH 14 60	78,75	83	1113006009	1/2" TORX UÇ LKM ANH TK9	770,50	83
1113064117	1/2" ALLEN UÇ LKM ANH 17 100	151,75	83	1513067003	1/2"FX3/4" M HVL LKM ADP	176,25	92
1113001107	1/2" ALLEN UÇ LKM ANH TK7	512,25	83	1513060003	1/2"FX3/4" M LKM ADP	83,25	85
1113006017	1/2" ALLEN UÇ&TORX UÇ LKM ANH SET17	1.530,50	84	1513067002	1/2"FX3/8" M HVL LKM ADP	154,50	92
1513064125	1/2" ARA KOL 125	113,50	85	1513060002	1/2"FX3/8" M LKM ADP	53,00	85
1514064125	1/2" ARA KOL 125 ELTA	88,00	193	1107064004	1/4" 6KŞ DRN LKM ANH 04	25,25	73
1513064250	1/2" ARA KOL 250	172,50	85	1107064005	1/4" 6KŞ DRN LKM ANH 05	25,25	73
1514064250	1/2" ARA KOL 250 ELTA	152,50	193	1107064006	1/4" 6KŞ DRN LKM ANH 06	28,50	73
1513064075	1/2" ARA KOL 75	101,50	85	1107064007	1/4" 6KŞ DRN LKM ANH 07	28,50	73

KOD	ÜRÜN	FİYAT	SAYFA
1107064008	1/4" 6KŞ DRN LKM ANH 08	28,50	73
1107064009	1/4" 6KŞ DRN LKM ANH 09	30,50	73
1107064010	1/4" 6KŞ DRN LKM ANH 10	30,50	73
1107064011	1/4" 6KŞ DRN LKM ANH 11	32,75	73
1107064012	1/4" 6KŞ DRN LKM ANH 12	32,75	73
1107064013	1/4" 6KŞ DRN LKM ANH 13	32,75	73
1107064055	1/4" 6KŞ DRN LKM ANH 5,5	25,25	73
1107060014	1/4" 6KŞ DRN LKM ANH SET14	627,50	73
1107060004	1/4" 6KŞ LKM ANH 04	13,00	73
1107060005	1/4" 6KŞ LKM ANH 05	13,00	73
1107060006	1/4" 6KŞ LKM ANH 06	13,00	73
1107060007	1/4" 6KŞ LKM ANH 07	13,00	73
1107060008	1/4" 6KŞ LKM ANH 08	13,00	73
1107060009	1/4" 6KŞ LKM ANH 09	14,25	73
1107060010	1/4" 6KŞ LKM ANH 10	14,25	73
1107060011	1/4" 6KŞ LKM ANH 11	18,00	73
1107060012	1/4" 6KŞ LKM ANH 12	18,00	73
1107060013	1/4" 6KŞ LKM ANH 13	20,50	73
1107060045	1/4" 6KŞ LKM ANH 4,5	13,00	73
1107060055	1/4" 6KŞ LKM ANH 5,5	13,00	73
1107060015	1/4" 6KŞ LKM ANH SET15	577,75	77
1107061103	1/4" ALLEN UÇ LKM ANH 03	22,25	74
1107061104	1/4" ALLEN UÇ LKM ANH 04	22,25	74
1107061105	1/4" ALLEN UÇ LKM ANH 05	22,25	74
1107061106	1/4" ALLEN UÇ LKM ANH 06	22,25	74
1107061107	1/4" ALLEN UÇ LKM ANH 07	26,25	74
1107061108	1/4" ALLEN UÇ LKM ANH 08	26,25	74
1107061110	1/4" ALLEN UÇ LKM ANH 10	31,50	74
1107061125	1/4" ALLEN UÇ LKM ANH 2,5	22,25	74
1507060100	1/4" ARA KOL 100	36,00	75
1507060050	1/4" ARA KOL 50	33,25	75
1507063150	1/4" ARA KOL FLEX 150	146,75	75
1107065010	1/4" BİTS TUTC LKM MIKN	49,25	77
4784196346	1/4" BİTS TUTC TRNV AVUÇ İÇİ	289,00	146
1107001042	1/4" BİTS UÇ LKM ANH SET42	1.297,00	75
1507062140	1/4" CRC KOL 140	237,75	76
1507062110	1/4" CRC KOL 72DİŞ LKM&BİTS TUTC 110	495,00	76
1607060420	1/4" CRC TORK ANH 4-20NM	2.940,25	97
1107061310	1/4" DLK TORX UÇ LKM ANH TR10	26,75	74
1107061315	1/4" DLK TORX UÇ LKM ANH TR15	26,75	74
1107061320	1/4" DLK TORX UÇ LKM ANH TR20	26,75	74
1107061325	1/4" DLK TORX UÇ LKM ANH TR25	26,75	74
1107061327	1/4" DLK TORX UÇ LKM ANH TR27	26,75	74
1107061330	1/4" DLK TORX UÇ LKM ANH TR30	26,75	74
1107061340	1/4" DLK TORX UÇ LKM ANH TR40	31,25	74
1107061308	1/4" DLK TORX UÇ LKM ANH TR8	26,75	74
1107061309	1/4" DLK TORX UÇ LKM ANH TR9	26,75	74
1507064080	1/4" DRN LKM TRNV ADP	70,75	77
1107061403	1/4" DÜZ UÇ LKM ANH 03	22,25	74
1107061404	1/4" DÜZ UÇ LKM ANH 04	22,25	74
1107061407	1/4" DÜZ UÇ LKM ANH 07	22,25	74
1107061408	1/4" DÜZ UÇ LKM ANH 08	29,00	74
1107061410	1/4" DÜZ UÇ LKM ANH 10	31,25	74
1107061435	1/4" DÜZ UÇ LKM ANH 3,5	22,25	74
1107061445	1/4" DÜZ UÇ LKM ANH 4,5	22,25	74
1107061455	1/4" DÜZ UÇ LKM ANH 5,5	22,25	74
1107061465	1/4" DÜZ UÇ LKM ANH 6,5	22,25	74
1507066140	1/4" MAND CRC KOL 140	340,25	76
1507060038	1/4" MFSL	61,00	75
1507062150	1/4" MFSL CRC KOL 72DİŞ 150	788,75	76
1507067115	1/4" MFSL T CRC KOL 72DİŞ 115	757,75	76
1507064115	1/4" T KOL	59,75	75
1107061210	1/4" TORX UÇ LKM ANH T10	23,00	74
1107061215	1/4" TORX UÇ LKM ANH T15	23,00	74
1107061220	1/4" TORX UÇ LKM ANH T20	23,00	74
1107061225	1/4" TORX UÇ LKM ANH T25	23,00	74
1107061227	1/4" TORX UÇ LKM ANH T27	23,00	74

KOD	ÜRÜN	FİYAT	SAYFA
1107061230	1/4" TORX UÇ LKM ANH T30	23,00	74
1107061240	1/4" TORX UÇ LKM ANH T40	23,00	74
1107061208	1/4" TORX UÇ LKM ANH T8	23,00	74
1107061209	1/4" TORX UÇ LKM ANH T9	23,00	74
1107061501	1/4" YLD UÇ LKM ANH PH1	22,25	75
1107061502	1/4" YLD UÇ LKM ANH PH2	22,25	75
1107061503	1/4" YLD UÇ LKM ANH PH3	22,25	75
1107061504	1/4" YLD UÇ LKM ANH PH4	22,25	75
1113001038	1/4"&1/2" 6KŞ LKM ANH SET35	2.415,00	86
1507060004	1/4"FX3/8" M LKM ADP	30,75	77
4805205011	1/4"M-1/2" M BİTS UÇ LKM ADP	52,25	143
4805205010	1/4"M-1/4" M BİTS UÇ LKM ADP	25,75	143
1300005148	1000V 1/2" 6KŞ LKM ANH 10	226,00	80
1300005149	1000V 1/2" 6KŞ LKM ANH 11	224,75	80
1300005150	1000V 1/2" 6KŞ LKM ANH 12	228,75	80
1300005151	1000V 1/2" 6KŞ LKM ANH 13	229,75	80
1300005152	1000V 1/2" 6KŞ LKM ANH 14	231,50	80
1300005153	1000V 1/2" 6KŞ LKM ANH 15	232,75	80
1300005154	1000V 1/2" 6KŞ LKM ANH 16	237,25	80
1300005155	1000V 1/2" 6KŞ LKM ANH 17	240,25	80
1300005156	1000V 1/2" 6KŞ LKM ANH 19	245,50	80
1300005157	1000V 1/2" 6KŞ LKM ANH 22	251,50	80
1300005158	1000V 1/2" 6KŞ LKM ANH 24	256,75	80
1300005159	1000V 1/2" 6KŞ LKM ANH 27	302,75	80
1300005263	1000V 1/2" ARA KOL 125	641,50	85
1300005264	1000V 1/2" ARA KOL 250	871,50	85
1300005262	1000V 1/2" ARA KOL 75	578,75	85
1300005277	1000V 1/2" CRC KOL 30DİŞ	2.184,25	84
3715166165	1000V 1A KBLO KSC	355,75	113
3220136140	1000V DÜZ UÇ KRGB 140	316,50	106
3220136160	1000V DÜZ UÇ KRGB 160	350,00	106
3220136180	1000V DÜZ UÇ KRGB 180	392,75	106
3220136200	1000V DÜZ UÇ KRGB 200	408,00	106
4140172575	1000V DÜZ UÇ TRNV 2,5X75	50,75	135
4140174100	1000V DÜZ UÇ TRNV 4X100	59,50	135
4140175512	1000V DÜZ UÇ TRNV 5,5X125	78,50	135
4140176515	1000V DÜZ UÇ TRNV 6,5X150	87,75	135
4140009106	1000V DÜZ&YLD UÇ TRNV SET6	438,75	135
3020006003	1000V ELKT 160 SET3	1.062,00	124
8795006005	1000V ELKT SET5	1.308,25	126
3020126160	1000V KMB PNS 160	309,25	105
3020126180	1000V KMB PNS 180	331,25	105
3020126200	1000V KMB PNS 200	373,75	105
4773190040	1000V LKM UÇ TRNV 04	165,00	141
4773190050	1000V LKM UÇ TRNV 05	165,00	141
4773190060	1000V LKM UÇ TRNV 06	165,00	141
4773190070	1000V LKM UÇ TRNV 07	176,75	141
4773190080	1000V LKM UÇ TRNV 08	176,75	141
4773190090	1000V LKM UÇ TRNV 09	191,00	141
4773190100	1000V LKM UÇ TRNV 10	191,00	141
4773190110	1000V LKM UÇ TRNV 11	208,50	141
4773190120	1000V LKM UÇ TRNV 12	223,75	141
4773190130	1000V LKM UÇ TRNV 13	241,00	141
4773190140	1000V LKM UÇ TRNV 14	266,50	141
4773190055	1000V LKM UÇ TRNV 5,5	165,00	141
4773008108	1000V LKM UÇ TRNV TK8	1.573,75	141
4783196120	1000V MNY BİTS TUTC TRNV 6,3X120	185,50	142
2400116240	1000V ÜNV FORT PNS 240	419,25	102
4145180360	1000V YLD UÇ TRNV 3X60	52,75	135
4145184580	1000V YLD UÇ TRNV 4,5X80	74,50	135
4145186100	1000V YLD UÇ TRNV 6X100	87,75	135
3700166140	1000V YNKS 140	354,75	108
3700166160	1000V YNKS 160	402,75	108
3700166180	1000V YNKS 180	450,50	108
2201100015	1-1/2" MŞL BORU ANH 85	653,50	101
2203100015	1-1/2" MŞL BORU ANH 85 ELTA	552,50	195
2201100115	1-1/2" MŞL BORU ANH YP SMN 85	27,25	202

KOD	ÜRÜN	FİYAT	SAYFA	KOD	ÜRÜN	FİYAT	SAYFA
3715160165	1A KBLO KSC	301,75	113	0100011819	2A ANH KB 1819	56,00	49
1841070021	1A KVN ANH&MİL 21 SET2	103,50	95	0100011820	2A ANH KB 1820	69,50	49
0255010010	1A SPR İZL ANH 10	107,50	52	0100011822	2A ANH KB 1822	69,50	49
0255010011	1A SPR İZL ANH 11	113,50	52	0100011922	2A ANH KB 1922	63,00	49
0255010012	1A SPR İZL ANH 12	118,75	52	0100011924	2A ANH KB 1924	72,25	49
0255010013	1A SPR İZL ANH 13	127,75	52	0100012022	2A ANH KB 2022	65,25	49
0255010014	1A SPR İZL ANH 14	132,50	52	0100012123	2A ANH KB 2123	68,50	49
0255010017	1A SPR İZL ANH 17	162,50	52	0100012224	2A ANH KB 2224	71,50	49
0255010019	1A SPR İZL ANH 19	190,75	52	0100012226	2A ANH KB 2226	79,75	49
0255010022	1A SPR İZL ANH 22	256,50	52	0100012227	2A ANH KB 2227	79,75	49
0255010024	1A SPR İZL ANH 24	314,00	52	0100012426	2A ANH KB 2426	73,50	49
0435030010	1A SPR İZL YLD ANH SB 10	143,25	63	0100012427	2A ANH KB 2427	73,50	49
0435030011	1A SPR İZL YLD ANH SB 11	143,25	63	0100012430	2A ANH KB 2430	115,00	49
0435030012	1A SPR İZL YLD ANH SB 12	162,50	63	0100012528	2A ANH KB 2528	91,25	49
0435030013	1A SPR İZL YLD ANH SB 13	162,50	63	0100012730	2A ANH KB 2730	115,00	49
0435030014	1A SPR İZL YLD ANH SB 14	170,75	63	0100012732	2A ANH KB 2732	108,75	49
0435030017	1A SPR İZL YLD ANH SB 17	193,25	63	0100013032	2A ANH KB 3032	108,75	49
0435030019	1A SPR İZL YLD ANH SB 19	230,75	63	0100002112	2A ANH KB TK12	698,00	49
0435030022	1A SPR İZL YLD ANH SB 22	252,75	63	0100002108	2A ANH KB TK8	356,00	49
0435030024	1A SPR İZL YLD ANH SB 24	337,75	63	0150010607	2A ANH SB 0607 ELTA	26,50	190
0250010021	1A TAÇ ANH 21	-	52	0150010809	2A ANH SB 0809 ELTA	27,00	190
0250010022	1A TAÇ ANH 22	-	52	0150011011	2A ANH SB 1011 ELTA	29,25	190
0250010023	1A TAÇ ANH 23	-	52	0150011213	2A ANH SB 1213 ELTA	32,25	190
0250010024	1A TAÇ ANH 24	-	52	0150011415	2A ANH SB 1415 ELTA	37,50	190
0250010025	1A TAÇ ANH 25	-	52	0150011617	2A ANH SB 1617 ELTA	43,25	190
0250010027	1A TAÇ ANH 27	-	52	0150011819	2A ANH SB 1819 ELTA	46,50	190
0250010030	1A TAÇ ANH 30	183,75	52	0150012022	2A ANH SB 2022 ELTA	52,75	190
0250010032	1A TAÇ ANH 32	-	52	0150012123	2A ANH SB 2123 ELTA	57,50	190
0250010034	1A TAÇ ANH 34	-	52	0150012426	2A ANH SB 2426 ELTA	66,00	190
0250010036	1A TAÇ ANH 36	232,00	52	0150012528	2A ANH SB 2528 ELTA	79,25	190
0250010038	1A TAÇ ANH 38	-	52	0150012732	2A ANH SB 2732 ELTA	94,50	190
0250010041	1A TAÇ ANH 41	302,75	52	0150002112	2A ANH SB TK12 ELTA	592,25	190
0250010046	1A TAÇ ANH 46	326,00	52	0150002108	2A ANH SB TK8 ELTA	295,00	190
0250010050	1A TAÇ ANH 50	407,00	52	8001316012	2A ANH SHP	172,50	209
0250010055	1A TAÇ ANH 55	545,25	52	0130010555	2A ANH UB 05X5,5	31,50	50
0250010060	1A TAÇ ANH 60	698,25	52	0130010607	2A ANH UB 0607	40,00	50
0250010065	1A TAÇ ANH 65	851,00	52	0130010608	2A ANH UB 0608	41,50	50
0250010070	1A TAÇ ANH 70	-	52	0130010708	2A ANH UB 0708	41,50	50
0250010075	1A TAÇ ANH 75	-	52	0130010709	2A ANH UB 0709	41,50	50
2201100020	2" MŞL BORU ANH 85	978,50	101	0130010809	2A ANH UB 0809	41,50	50
2203100020	2" MŞL BORU ANH 85 ELTA	823,75	195	0130010810	2A ANH UB 0810	41,50	50
2201100120	2" MŞL BORU ANH YP SMN 85	36,00	202	0130010910	2A ANH UB 0910	45,75	50
0100010405	2A ANH KB 0405	30,75	49	0130010911	2A ANH UB 0911	45,75	50
0100010607	2A ANH KB 0607	31,50	49	0161011214	2A ANH UB 1/2X9/16 SAE	57,75	51
0100010608	2A ANH KB 0608	35,00	49	0161010608	2A ANH UB 1/4X5/16 SAE	49,50	51
0100010708	2A ANH KB 0708	35,00	49	0130011011	2A ANH UB 1011	45,75	50
0100010709	2A ANH KB 0709	35,00	49	0130011012	2A ANH UB 1012	45,75	50
0100010809	2A ANH KB 0809	32,25	49	0130011013	2A ANH UB 1013	45,75	50
0100010810	2A ANH KB 0810	35,50	49	0130011014	2A ANH UB 1014	45,75	50
0100010910	2A ANH KB 0910	36,50	49	0161012631	2A ANH UB 1-1/16X1-1/4 SAE	169,50	51
0100010911	2A ANH KB 0911	38,75	49	0161012628	2A ANH UB 1-1/16X1-1/8 SAE	160,50	51
0100011011	2A ANH KB 1011	35,25	49	0161012833	2A ANH UB 1-1/8X1-5/16 SAE	169,50	51
0100011012	2A ANH KB 1012	35,25	49	0130011113	2A ANH UB 1113	45,75	50
0100011013	2A ANH KB 1013	37,75	49	0130011114	2A ANH UB 1114	45,75	50
0100011014	2A ANH KB 1014	44,00	49	0130011213	2A ANH UB 1213	48,25	50
0100011113	2A ANH KB 1113	38,75	49	0130011214	2A ANH UB 1214	48,25	50
0100011114	2A ANH KB 1114	45,00	49	0161012122	2A ANH UB 13/16X7/8 SAE	93,75	51
0100011213	2A ANH KB 1213	38,75	49	0130011314	2A ANH UB 1314	48,25	50
0100011214	2A ANH KB 1214	38,75	49	0130011315	2A ANH UB 1315	48,25	50
0100011314	2A ANH KB 1314	38,75	49	0130011317	2A ANH UB 1317	61,25	50
0100011315	2A ANH KB 1315	44,75	49	0130011415	2A ANH UB 1415	56,00	50
0100011317	2A ANH KB 1317	50,75	49	0130011417	2A ANH UB 1417	61,25	50
0100011415	2A ANH KB 1415	44,75	49	0161012325	2A ANH UB 15/16X1 SAE	110,50	51
0100011417	2A ANH KB 1417	52,25	49	0161012328	2A ANH UB 15/16X1-1/8 SAE	111,75	51
0100011617	2A ANH KB 1617	52,25	49	0130011617	2A ANH UB 1617	61,75	50
0100011719	2A ANH KB 1719	56,00	49	0161012328	2A ANH UB 15/16X1-1/8 SAE	111,75	51
0100011722	2A ANH KB 1722	69,50	49	0130011617	2A ANH UB 1617	61,75	50

KOD	ÜRÜN	FİYAT	SAYFA
1800070607	2A KVN ANH 0607	62,25	95
1800070809	2A KVN ANH 0809	68,25	95
1800071011	2A KVN ANH 1011	93,50	95
1800071213	2A KVN ANH 1213	99,25	95
1800071415	2A KVN ANH 1415	108,75	95
1800071617	2A KVN ANH 1617	116,75	95
1800071819	2A KVN ANH 1819	121,00	95
1800072022	2A KVN ANH 2022	133,25	95
1800072224	2A KVN ANH 2224	149,75	95
1800072427	2A KVN ANH 2427	193,50	95
1800002108	2A KVN ANH SET10	865,00	95
0540010810	2A RKR ANH 0810	131,75	63
0540011011	2A RKR ANH 1011	136,75	63
0540011012	2A RKR ANH 1012	136,75	63
0540011113	2A RKR ANH 1113	146,50	63
0540011214	2A RKR ANH 1214	146,50	63
0540011719	2A RKR ANH 1719	261,50	63
0540011922	2A RKR ANH 1922	313,00	63
6240260810	2A TAPA ANH 08X10	141,50	167
0430030607	2A YLD ANH SB 0607	71,75	60
0450030607	2A YLD ANH SB 0607 ELTA	59,50	192
0430030809	2A YLD ANH SB 0809	72,75	60
0450030809	2A YLD ANH SB 0809 ELTA	60,25	192
0430030810	2A YLD ANH SB 0810	72,75	60
0431031217	2A YLD ANH SB 1/2X11/16 SAE	130,50	61
0431031214	2A YLD ANH SB 1/2X9/16 SAE	115,50	61
0431030608	2A YLD ANH SB 1/4X5/16 SAE	88,50	61
0430031011	2A YLD ANH SB 1011	80,50	60
0450031011	2A YLD ANH SB 1011 ELTA	67,00	192
0430031012	2A YLD ANH SB 1012	80,50	60
0430031013	2A YLD ANH SB 1013	91,25	60
0430031014	2A YLD ANH SB 1014	91,25	60
0431032631	2A YLD ANH SB 1-1/16X1-1/4 SAE	273,50	61
0431032326	2A YLD ANH SB 1-1/4X1-7/16 SAE	421,50	61
0431032833	2A YLD ANH SB 1-1/8X1-5/16 SAE	273,50	61
0431034146	2A YLD ANH SB 1-11/16X1-7/8 SAE	784,75	61
0430031113	2A YLD ANH SB 1113	91,25	60
0431034650	2A YLD ANH SB 1-13/16X2 SAE	1.248,75	61
0430031213	2A YLD ANH SB 1213	91,25	60
0450031213	2A YLD ANH SB 1213 ELTA	75,50	192
0430031214	2A YLD ANH SB 1214	91,25	60
0431033036	2A YLD ANH SB 1-3/16 X1-3/8 SAE	421,50	61
0431033033	2A YLD ANH SB 1-3/16X1-5/16 SAE	291,75	61
0431032122	2A YLD ANH SB 13/16X7/8 SAE	194,75	61
0430031315	2A YLD ANH SB 1315	96,00	60
0430031317	2A YLD ANH SB 1317	108,75	60
0430031415	2A YLD ANH SB 1415	96,00	60
0450031415	2A YLD ANH SB 1415 ELTA	79,25	192
0430031417	2A YLD ANH SB 1417	108,75	60
0431032325	2A YLD ANH SB 15/16X1 SAE	227,25	61
0431032328	2A YLD ANH SB 15/16x1-1/8 SAE	227,25	61
0430031617	2A YLD ANH SB 1617	108,75	60
0450031617	2A YLD ANH SB 1617 ELTA	89,75	192
0430031618	2A YLD ANH SB 1618	129,25	60
0431033641	2A YLD ANH SB 1-7/16X1-5/8 SAE	573,00	61
0430031719	2A YLD ANH SB 1719	129,25	60
0430031819	2A YLD ANH SB 1819	129,25	60
0450031819	2A YLD ANH SB 1819 ELTA	107,25	192
0431031517	2A YLD ANH SB 19/32X11/16 SAE	130,50	61
0430031922	2A YLD ANH SB 1922	141,75	60
0430031924	2A YLD ANH SB 1924	141,75	60
0431032528	2A YLD ANH SB 1X1-1/8 SAE	248,50	61
0430032022	2A YLD ANH SB 2022	141,75	60
0450032022	2A YLD ANH SB 2022 ELTA	117,25	192
0430032123	2A YLD ANH SB 2123	162,50	60
0450032123	2A YLD ANH SB 2123 ELTA	134,50	192
0430032224	2A YLD ANH SB 2224	162,50	60

KOD	ÜRÜN	FİYAT	SAYFA
0430032227	2A YLD ANH SB 2227	189,50	60
0430032426	2A YLD ANH SB 2426	189,50	60
0450032426	2A YLD ANH SB 2426 ELTA	156,50	192
0430032427	2A YLD ANH SB 2427	189,50	60
0430032430	2A YLD ANH SB 2430	207,25	60
0431032021	2A YLD ANH SB 25/32X13/16 SAE	170,00	61
0430032528	2A YLD ANH SB 2528	207,25	60
0450032528	2A YLD ANH SB 2528 ELTA	171,50	192
0430032729	2A YLD ANH SB 2729	228,00	60
0430032730	2A YLD ANH SB 2730	228,00	60
0430032732	2A YLD ANH SB 2732	228,00	60
0450032732	2A YLD ANH SB 2732 ELTA	189,00	192
0431031920	2A YLD ANH SB 3/4X25/32 SAE	162,00	61
0431031922	2A YLD ANH SB 3/4X7/8 SAE	170,00	61
0431030911	2A YLD ANH SB 3/8X7/16 SAE	101,50	61
0430033032	2A YLD ANH SB 3032	228,00	60
0430033034	2A YLD ANH SB 3034	303,00	60
0430033036	2A YLD ANH SB 3036	351,50	60
0430033236	2A YLD ANH SB 3236	351,50	60
0430033436	2A YLD ANH SB 3436	429,75	60
0430033641	2A YLD ANH SB 3641	477,50	60
0430034146	2A YLD ANH SB 4146	654,25	60
0430034650	2A YLD ANH SB 4650	1.041,00	60
0431030809	2A YLD ANH SB 5/16X3/8 SAE	92,00	61
0431030811	2A YLD ANH SB 5/16X7/16 SAE	96,25	61
0431031617	2A YLD ANH SB 5/8X11/16 SAE	130,50	61
0431031619	2A YLD ANH SB 5/8X3/4 SAE	155,50	61
0431031112	2A YLD ANH SB 7/16X1/2 SAE	109,50	61
0431032223	2A YLD ANH SB 7/8X15/16 SAE	194,75	61
0431031417	2A YLD ANH SB 9/16x11/16 SAE	130,50	61
0431031415	2A YLD ANH SB 9/16X19/32 SAE	115,50	61
0431031416	2A YLD ANH SB 9/16X5/8 SAE	116,50	61
8002316012	2A YLD ANH SB SHP	215,25	209
0430002112	2A YLD ANH SB TK12	1.579,25	60
0450002112	2A YLD ANH SB TK12 ELTA	1.307,25	192
0431002112	2A YLD ANH SB TK12 SAE	2.061,25	61
0430002108	2A YLD ANH SB TK8	792,00	60
0450002108	2A YLD ANH SB TK8 ELTA	655,75	192
0431002108	2A YLD ANH SB TK8 SAE	1.121,00	61
6375266512	2YÖN 3AYK YAĞ FLT SÖKM 65-120	733,50	168
6380266016	2ZNCR YAĞ FLT SÖKM 60-16	1.986,25	168
0741550003	3 SRL TEL FRÇ	32,50	169
2201100030	3" MŞL BORU ANH 85	1.483,50	101
2201100130	3" MŞL BORU ANH YP SMN 85	48,25	202
1419061025	3/4" 12KŞ LKM ANH 1 SAE	149,00	89
1419061027	3/4" 12KŞ LKM ANH 1-1/16 SAE	153,00	89
1419061038	3/4" 12KŞ LKM ANH 1-1/2 SAE	223,75	89
1419061032	3/4" 12KŞ LKM ANH 1-1/4 SAE	171,50	89
1419061028	3/4" 12KŞ LKM ANH 1-1/8 SAE	153,00	89
1419061046	3/4" 12KŞ LKM ANH 1-13/16 SAE	352,00	89
1419061044	3/4" 12KŞ LKM ANH 1-3/4 SAE	349,75	89
1419061035	3/4" 12KŞ LKM ANH 1-3/8 SAE	213,50	89
1419061024	3/4" 12KŞ LKM ANH 15/16 SAE	148,50	89
1419061033	3/4" 12KŞ LKM ANH 1-5/16 SAE	213,50	89
1419061041	3/4" 12KŞ LKM ANH 1-5/8 SAE	331,50	89
1419061036	3/4" 12KŞ LKM ANH 1-7/16 SAE	223,75	89
1419061047	3/4" 12KŞ LKM ANH 1-7/8 SAE	422,25	89
1419061050	3/4" 12KŞ LKM ANH 2 SAE	425,25	89
1120061022	3/4" 12KŞ LKM ANH 22	141,50	89
1120061024	3/4" 12KŞ LKM ANH 24	141,50	89
1120061027	3/4" 12KŞ LKM ANH 27	146,00	89
1120061030	3/4" 12KŞ LKM ANH 30	157,25	89
1120061032	3/4" 12KŞ LKM ANH 32	164,50	89
1120061034	3/4" 12KŞ LKM ANH 34	216,25	89
1120061036	3/4" 12KŞ LKM ANH 36	216,25	89
1120061041	3/4" 12KŞ LKM ANH 41	319,25	89
1120061046	3/4" 12KŞ LKM ANH 46	339,50	89

KOD	ÜRÜN	FİYAT	SAYFA	KOD	ÜRÜN	FİYAT	SAYFA
1120061050	3/4" 12KŞ LKM ANH 50	406,25	89	1610060100	3/8" TORK ANH 2,5-11NM	3.714,50	97
1419061022	3/4" 12KŞ LKM ANH 7/8 SAE	148,50	89	1610060300	3/8" TORK ANH 7-33NM	3.840,25	97
1120006014	3/4" 12KŞ LKM ANH SET14	5.268,75	90	1510060007	3/8"FX1/2M" LKM ADP	68,25	79
1419006114	3/4" 12KŞ LKM ANH SET14 SAE	5.476,25	90	0741550004	4 SRL TEL FRÇ	34,25	169
1119067019	3/4" 6KŞ HVL LKM ANH 19	206,75	93	2201100040	4" MŞL BORU ANH 85	2.224,75	101
1119067021	3/4" 6KŞ HVL LKM ANH 21	206,75	93	2201100140	4" MŞL BORU ANH YP SMN 85	56,75	202
1119067022	3/4" 6KŞ HVL LKM ANH 22	206,75	93	0741550005	5 SRL TEL FRÇ	38,25	169
1119067024	3/4" 6KŞ HVL LKM ANH 24	206,75	93	0741550006	6 SRL TEL FRÇ	41,00	169
1119067027	3/4" 6KŞ HVL LKM ANH 27	212,75	93	4908220020	6KŞ ALLEN ANH 02 ELTA	5,25	198
1119067030	3/4" 6KŞ HVL LKM ANH 30	229,25	93	4908220030	6KŞ ALLEN ANH 03 ELTA	7,25	198
1119067032	3/4" 6KŞ HVL LKM ANH 32	229,25	93	4908220040	6KŞ ALLEN ANH 04 ELTA	9,50	198
1119067034	3/4" 6KŞ HVL LKM ANH 34	298,75	93	4908220050	6KŞ ALLEN ANH 05 ELTA	10,00	198
1119067036	3/4" 6KŞ HVL LKM ANH 36	298,75	93	4908220060	6KŞ ALLEN ANH 06 ELTA	13,75	198
1119067041	3/4" 6KŞ HVL LKM ANH 41	461,00	93	4908220070	6KŞ ALLEN ANH 07 ELTA	19,50	198
1119067046	3/4" 6KŞ HVL LKM ANH 46	490,00	93	4908220080	6KŞ ALLEN ANH 08 ELTA	22,50	198
1119061022	3/4" 6KŞ LKM ANH 22	134,00	89	4908220090	6KŞ ALLEN ANH 09 ELTA	31,75	198
1119061024	3/4" 6KŞ LKM ANH 24	134,00	89	4900220015	6KŞ ALLEN ANH 1,5	5,00	147
1119061027	3/4" 6KŞ LKM ANH 27	138,25	89	4908220015	6KŞ ALLEN ANH 1,5 ELTA	4,25	198
1119061030	3/4" 6KŞ LKM ANH 30	149,00	89	4901221270	6KŞ ALLEN ANH 1/2 SAE	75,25	147
1119061032	3/4" 6KŞ LKM ANH 32	155,00	89	4901226350	6KŞ ALLEN ANH 1/4 SAE	26,00	147
1119061034	3/4" 6KŞ LKM ANH 34	204,50	89	4901223125	6KŞ ALLEN ANH 1/8 SAE	12,75	147
1119061036	3/4" 6KŞ LKM ANH 36	204,50	89	4908220100	6KŞ ALLEN ANH 10 ELTA	34,25	198
1119061038	3/4" 6KŞ LKM ANH 38	204,50	89	4908220120	6KŞ ALLEN ANH 12 ELTA	50,00	198
1119061041	3/4" 6KŞ LKM ANH 41	300,50	89	4908220025	6KŞ ALLEN ANH 2,5 ELTA	6,25	198
1119061046	3/4" 6KŞ LKM ANH 46	320,00	89	4908220035	6KŞ ALLEN ANH 3,5 ELTA	8,25	198
1119061050	3/4" 6KŞ LKM ANH 50	384,25	89	4901224762	6KŞ ALLEN ANH 3/16 SAE	16,00	147
1119061055	3/4" 6KŞ LKM ANH 55	489,25	89	4901222381	6KŞ ALLEN ANH 3/32 SAE	10,50	147
1119061060	3/4" 6KŞ LKM ANH 60	584,25	89	4901221905	6KŞ ALLEN ANH 3/4 SAE	238,50	147
1119006114	3/4" 6KŞ LKM ANH SET14	5.144,50	90	4901229825	6KŞ ALLEN ANH 3/8 SAE	44,50	147
1519064200	3/4" ARA KOL 200	350,50	89	4901227937	6KŞ ALLEN ANH 5/16 SAE	32,25	147
1519064400	3/4" ARA KOL 400	634,75	89	4901223968	6KŞ ALLEN ANH 5/32 SAE	15,50	147
1519064510	3/4" CRC KOL 510	1.329,00	89	4901221984	6KŞ ALLEN ANH 5/64 SAE	9,75	147
1619061060	3/4" CRC TORK ANH 100-600NM	10.782,00	97	4901221587	6KŞ ALLEN ANH 5/8 SAE	170,50	147
1519067175	3/4" HVL LKM ARA KOL 175	509,25	93	4901221111	6KŞ ALLEN ANH 7/16 SAE	59,75	147
1519067250	3/4" HVL LKM ARA KOL 250	728,25	93	4901225556	6KŞ ALLEN ANH 7/32 SAE	21,25	147
1519067330	3/4" HVL LKM ARA KOL 330	1.105,25	93	4901221428	6KŞ ALLEN ANH 9/16 SAE	109,75	147
1519067108	3/4" HVL LKM MFSL 108	848,25	93	4900220020	6KŞ ALLEN ANH KB 02	7,25	147
1519064500	3/4" T KOL 500	706,25	90	4900220030	6KŞ ALLEN ANH KB 03	9,75	147
1619062080	3/4" TORK ANH 200-800NM	15.349,25	97	4900220040	6KŞ ALLEN ANH KB 04	12,50	147
1519060001	3/4"FX1" M LKM ADP	189,00	90	4900220050	6KŞ ALLEN ANH KB 05	14,50	147
1519067011	3/4"FX1/2" M HVL LKM ADP	294,00	93	4900220060	6KŞ ALLEN ANH KB 06	19,00	147
1519060008	3/4"FX1/2" M LKM ADP	139,75	90	4900220070	6KŞ ALLEN ANH KB 07	28,00	147
1110060006	3/8" 6KŞ LKM ANH 06	33,75	78	4900220080	6KŞ ALLEN ANH KB 08	32,25	147
1110060007	3/8" 6KŞ LKM ANH 07	33,75	78	4900220090	6KŞ ALLEN ANH KB 09	39,75	147
1110060008	3/8" 6KŞ LKM ANH 08	33,75	78	4900220100	6KŞ ALLEN ANH KB 10	49,00	147
1110060009	3/8" 6KŞ LKM ANH 09	33,75	78	4900220120	6KŞ ALLEN ANH KB 12	71,00	147
1110060010	3/8" 6KŞ LKM ANH 10	33,75	78	4900220140	6KŞ ALLEN ANH KB 14	113,50	147
1110060011	3/8" 6KŞ LKM ANH 11	33,75	78	4900220160	6KŞ ALLEN ANH KB 16	209,25	147
1110060012	3/8" 6KŞ LKM ANH 12	33,75	78	4900220170	6KŞ ALLEN ANH KB 17	225,75	147
1110060013	3/8" 6KŞ LKM ANH 13	36,00	78	4900220190	6KŞ ALLEN ANH KB 19	279,00	147
1110060014	3/8" 6KŞ LKM ANH 14	36,00	78	4900220025	6KŞ ALLEN ANH KB 2,5	9,00	147
1110060015	3/8" 6KŞ LKM ANH 15	36,00	78	4900220220	6KŞ ALLEN ANH KB 22	465,75	147
1110060016	3/8" 6KŞ LKM ANH 16	37,50	78	4900220240	6KŞ ALLEN ANH KB 24	628,75	147
1110060017	3/8" 6KŞ LKM ANH 17	37,50	78	4900220035	6KŞ ALLEN ANH KB 3,5	12,25	147
1110060018	3/8" 6KŞ LKM ANH 18	39,00	78	4900003110	6KŞ ALLEN ANH KB TK10	221,00	147
1110060019	3/8" 6KŞ LKM ANH 19	45,00	78	4900003112	6KŞ ALLEN ANH KB TK12	304,25	147
1110060021	3/8" 6KŞ LKM ANH 21	50,75	78	4908003110	6KŞ ALLEN ANH TK10 ELTA	163,00	198
1110060022	3/8" 6KŞ LKM ANH 22	54,25	78	4901003110	6KŞ ALLEN ANH TK10 SAE	248,25	147
1110060023	3/8" 6KŞ LKM ANH 23	54,25	78	4901003112	6KŞ ALLEN ANH TK12 SAE	433,25	147
1110060019	3/8" 6KŞ LKM SET19	1.366,50	79	4908003107	6KŞ ALLEN ANH TK7 ELTA	56,25	198
1510060150	3/8" ARA KOL 150	92,50	78	4908003109	6KŞ ALLEN ANH TK9 ELTA	113,00	198
1510060075	3/8" ARA KOL 75	61,25	78	4903220020	6KŞ ALLEN ANH UB 02	10,50	148
1110069208	3/8" BUJİ LKM LSTK 20,8	72,25	78	4903220030	6KŞ ALLEN ANH UB 03	14,00	148
1510060200	3/8" CRC KOL 200	402,75	78	4903220040	6KŞ ALLEN ANH UB 04	17,75	148
1610062010	3/8" CRC TORK ANH 20-100NM	3.319,75	97	4903220050	6KŞ ALLEN ANH UB 05	19,75	148
1510060056	3/8" MFSL 56,5	99,25	78	4903220060	6KŞ ALLEN ANH UB 06	32,25	148
1510061200	3/8" T KOL	142,75	79	4903220070	6KŞ ALLEN ANH UB 07	47,75	148

KOD	ÜRÜN	FİYAT	SAYFA
4903220080	6KŞ ALLEN ANH UB 08	52,00	148
4903220090	6KŞ ALLEN ANH UB 09	70,50	148
4903220100	6KŞ ALLEN ANH UB 10	87,25	148
4903220120	6KŞ ALLEN ANH UB 12	125,50	148
4903220140	6KŞ ALLEN ANH UB 14	202,25	148
4903220160	6KŞ ALLEN ANH UB 16	327,00	148
4903220170	6KŞ ALLEN ANH UB 17	356,25	148
4903220190	6KŞ ALLEN ANH UB 19	527,75	148
4903220025	6KŞ ALLEN ANH UB 2,5	12,25	148
4903220035	6KŞ ALLEN ANH UB 3,5	17,25	148
4903003110	6KŞ ALLEN ANH UB TK10	364,00	148
4903003112	6KŞ ALLEN ANH UB TK12	506,75	148
4905220020	6KŞ YVRL BAŞL ALLEN ANH KB 02	11,75	148
4905220030	6KŞ YVRL BAŞL ALLEN ANH KB 03	16,25	148
4905220040	6KŞ YVRL BAŞL ALLEN ANH KB 04	20,00	148
4905220050	6KŞ YVRL BAŞL ALLEN ANH KB 05	21,00	148
4905220060	6KŞ YVRL BAŞL ALLEN ANH KB 06	34,00	148
4905220080	6KŞ YVRL BAŞL ALLEN ANH KB 08	52,25	148
4905220100	6KŞ YVRL BAŞL ALLEN ANH KB 10	83,00	148
4905220025	6KŞ YVRL BAŞL ALLEN ANH KB 2,5	14,25	148
4905007108	6KŞ YVRL BAŞL ALLEN ANH KB TK8	252,50	148
4906220020	6KŞ YVRL BAŞL ALLEN ANH UB 02	21,00	149
4906220030	6KŞ YVRL BAŞL ALLEN ANH UB 03	24,50	149
4906220040	6KŞ YVRL BAŞL ALLEN ANH UB 04	28,00	149
4906220050	6KŞ YVRL BAŞL ALLEN ANH UB 05	35,25	149
4906220060	6KŞ YVRL BAŞL ALLEN ANH UB 06	40,50	149
4906220080	6KŞ YVRL BAŞL ALLEN ANH UB 08	64,25	149
4906220015	6KŞ YVRL BAŞL ALLEN ANH UB 1,5	15,75	149
4906220100	6KŞ YVRL BAŞL ALLEN ANH UB 10	95,50	149
4906220025	6KŞ YVRL BAŞL ALLEN ANH UB 2,5	22,75	149
4906003109	6KŞ YVRL BAŞL ALLEN ANH UB TK9	347,50	149
1874092224	AGR 2A BJN ANH KB 2224	167,50	95
1874092427	AGR 2A BJN ANH KB 2427	214,00	95
1870092427	AGR 2A BJN ANH UB 2427	264,50	95
1870092730	AGR 2A BJN ANH UB 2730	303,75	95
1870092732	AGR 2A BJN ANH UB 2732	303,75	95
1870093032	AGR 2A BJN ANH UB 3032	314,25	95
1870093233	AGR 2A BJN ANH UB 3233	348,75	95
2110100010	AGR BORU ANH 10"	683,25	101
2110100012	AGR BORU ANH 12"	782,50	101
2110100014	AGR BORU ANH 14"	911,00	101
2110100018	AGR BORU ANH 18"	1.271,00	101
2110100024	AGR BORU ANH 24"	2.049,50	101
2110100036	AGR BORU ANH 36"	4.539,25	101
2110100048	AGR BORU ANH 48"	9.297,00	101
2110100008	AGR BORU ANH 8"	550,50	101
2110100410	AGR BORU ANH YP AÇENE&PİM 10"	324,75	202
2110100412	AGR BORU ANH YP AÇENE&PİM 12"	366,00	202
2110100414	AGR BORU ANH YP AÇENE&PİM 14"	377,50	202
2110100418	AGR BORU ANH YP AÇENE&PİM 18"	390,75	202
2110100424	AGR BORU ANH YP AÇENE&PİM 24"	430,00	202
2110100436	AGR BORU ANH YP AÇENE&PİM 36"	686,00	202
2110100448	AGR BORU ANH YP AÇENE&PİM 48"	926,00	202
2110100408	AGR BORU ANH YP AÇENE&PİM 8"	293,00	202
2110100110	AGR BORU ANH YP ÇENE 10"	338,00	202
2110100112	AGR BORU ANH YP ÇENE 12"	667,00	202
2110100114	AGR BORU ANH YP ÇENE 14"	711,50	202
2110100118	AGR BORU ANH YP ÇENE 18"	756,00	202
2110100124	AGR BORU ANH YP ÇENE 24"	1.133,75	202
2110100136	AGR BORU ANH YP ÇENE 36"	2.267,00	202
2110100148	AGR BORU ANH YP ÇENE 48"	3.733,75	202
2110100108	AGR BORU ANH YP ÇENE 8"	278,25	202
2110100310	AGR BORU ANH YP SMN 10"	96,00	202
2110100312	AGR BORU ANH YP SMN 12"	104,75	202
2110100314	AGR BORU ANH YP SMN 14"	127,00	202
2110100318	AGR BORU ANH YP SMN 18"	169,25	202
2110100324	AGR BORU ANH YP SMN 24"	258,00	202

KOD	ÜRÜN	FİYAT	SAYFA
2110100336	AGR BORU ANH YP SMN 36"	478,25	202
2110100348	AGR BORU ANH YP SMN 48"	767,00	202
2110100308	AGR BORU ANH YP SMN 8"	91,50	202
3835150280	AGR BTN KRPTN 280	376,50	117
3030122180	AGR KMB PNS 180	384,00	105
3030122200	AGR KMB PNS 200	439,25	105
3730162160	AGR YNKS 160	399,25	110
3730162200	AGR YNKS 200	518,75	110
6207270240	AL&SAC KSM MKS 240 DÜZ	345,25	175
6205270240	AL&SAC KSM MKS 240 SAĞ	345,25	175
6206270240	AL&SAC KSM MKS 240 SOL	345,25	175
6208000240	AL&SAC KSM MKS TK3	1.035,75	175
0588650020	ARZTİP FİB ŞRT SAPLI MT20	271,50	164
0588650030	ARZTİP FİB ŞRT SAPLI MT30	290,00	164
0588650050	ARZTİP FİB ŞRT SAPLI MT50	465,75	164
0615010200	AYR MNT ANH 200	378,75	66
2509110225	AYR PNS 225 ELTA	320,50	195
0637550100	AYR YAĞ FLT SÖKM 100	245,50	168
6721270205	BAĞ MKS 205 ELTA	222,00	200
6715270225	BAĞ MKS COMF 225	473,75	178
6720270220	BAĞ MKS HAF 220	549,50	178
6722270220	BAĞ MKS HAF 220 ELTA	320,25	200
6710270230	BAĞ MKS LUX 230	311,25	178
6735270300	BDM TSTR 300	424,50	164
6735271300	BDM TSTR YP BÇK 300	387,75	204
14000004137	BEL BTKÇ	319,25	44
0589950283	BİMETAL TSTR YP LAMA 13X0,65X24	51,50	204
4800008131	BİTS UÇ PLS KUTU SET31	364,00	143
4800008110	BİTS UÇ SET10 (25)	108,25	143
4850001013	BİTS UÇ SET13 (100)	443,00	146
4850001513	BİTS UÇ SET13 (150)	632,25	146
4850000713	BİTS UÇ SET13 (75)	296,50	146
4800008106	BİTS UÇ SET6 (25)	58,50	143
1975091719	BJN ANH İSTV	327,00	96
1850091630	BJN ANH MİL 18X630	154,00	95
1940090017	BJN ANH PİPO TRNV UÇ 17	164,25	96
1940090019	BJN ANH PİPO TRNV UÇ 19	173,50	96
1940090021	BJN ANH PİPO TRNV UÇ 21	187,50	96
8790008106	BKM ONRM SET5	990,50	40
8793001014	BKM SET14	1.071,00	41
6850281322	BORU KSC YP BÇK	68,75	204
0550050100	BORU UZT YLD ANH 100	-	65
0550050022	BORU UZT YLD ANH 22	-	65
0550050024	BORU UZT YLD ANH 24	250,75	65
0550050027	BORU UZT YLD ANH 27	299,00	65
0550050030	BORU UZT YLD ANH 30	357,00	65
0550050032	BORU UZT YLD ANH 32	410,00	65
0550050034	BORU UZT YLD ANH 34	-	65
0550050036	BORU UZT YLD ANH 36	463,75	65
0550050038	BORU UZT YLD ANH 38	535,00	65
0550050041	BORU UZT YLD ANH 41	606,00	65
0550050046	BORU UZT YLD ANH 46	725,00	65
0550050050	BORU UZT YLD ANH 50	856,00	65
0550050055	BORU UZT YLD ANH 55	1.204,00	65
0550050060	BORU UZT YLD ANH 60	1.306,50	65
0550050065	BORU UZT YLD ANH 65	1.414,75	65
0550050070	BORU UZT YLD ANH 70	-	65
0550050075	BORU UZT YLD ANH 75	-	65
0550050080	BORU UZT YLD ANH 80	-	65
0550050085	BORU UZT YLD ANH 85	-	65
0550050090	BORU UZT YLD ANH 90	-	65
0550050095	BORU UZT YLD ANH 95	-	65
14000004133	BTKÇ BYK	854,00	43
14000004134	BTKÇ KÇK	527,75	44
14000004135	BTKÇ ORTA	814,25	43
3830150225	BTN KRPTN 225	287,00	117
3832150225	BTN KRPTN 225 ELTA	240,25	196

KOD	ÜRÜN	FİYAT	SAYFA	KOD	ÜRÜN	FİYAT	SAYFA
3830150250	BTN KRPTN 250	317,00	117	2511110280	CTİP AYR PNS 280	719,75	103
3832150250	BTN KRPTN 250 ELTA	274,00	196	7010316105	ÇEK SHP	324,75	208
3830150280	BTN KRPTN 280	378,50	117	7010006105	ÇEK&SHP SET6	8.474,75	183
3832150280	BTN KRPTN 280 ELTA	328,50	196	6730270550	ÇİM KSM MKS DÜZ AĞZ 550 ELTA	293,25	200
3831150280	BTN KRPTN YAY 280	379,75	117	6731270650	ÇİM KSM MKS EĞRİ AĞZ 650 ELTA	524,00	200
7050290604	BTR ÇEK 2KOL 6X4	391,50	184	8320331001	ÇKM ALET SND KRMZ450	3.993,50	36
7050290606	BTR ÇEK 2KOL 6X6	403,75	184	8320331003	ÇKM ALET SND KRMZ650	4.369,75	36
7050290808	BTR ÇEK 2KOL 8X8	424,00	184	0335020010	ÇOK YLD CRC ANH 10X13X17X19	742,50	57
7060290604	BTR ÇEK 3KOL 6X4	508,25	184	0700050100	ÇTL ÇAK ANH 100	5.085,25	64
7060290606	BTR ÇEK 3KOL 6X6	640,75	184	0700050105	ÇTL ÇAK ANH 105	5.243,75	64
7060290808	BTR ÇEK 3KOL 8X8	743,25	184	0700050110	ÇTL ÇAK ANH 110	5.983,25	64
7050290422	BTR ÇEK YP KOL 6X4	67,25	205	0700050115	ÇTL ÇAK ANH 115	6.873,25	64
7050290622	BTR ÇEK YP KOL 6X6	75,25	205	0700050120	ÇTL ÇAK ANH 120	7.255,00	64
7050290822	BTR ÇEK YP KOL 8X8	86,25	205	0700050125	ÇTL ÇAK ANH 125	-	64
7050290444	BTR ÇEK YP MIL 6X4	100,00	205	0700050130	ÇTL ÇAK ANH 130	-	64
7050290644	BTR ÇEK YP MIL 6X6	111,75	205	0700050135	ÇTL ÇAK ANH 135	-	64
7050290844	BTR ÇEK YP MIL 8X8	140,75	205	0700050140	ÇTL ÇAK ANH 140	-	64
8550346001	BYK SRV ARB	4.806,25	31	0700050145	ÇTL ÇAK ANH 145	-	64
0370020006	BYN KMB ANH 06	47,75	58	0700050150	ÇTL ÇAK ANH 150	-	64
0370020007	BYN KMB ANH 07	50,75	58	0700050024	ÇTL ÇAK ANH 24	171,25	64
0370020008	BYN KMB ANH 08	55,00	58	0700050027	ÇTL ÇAK ANH 27	212,50	64
0370020009	BYN KMB ANH 09	56,25	58	0700050030	ÇTL ÇAK ANH 30	261,00	64
0370020010	BYN KMB ANH 10	63,75	58	0700050032	ÇTL ÇAK ANH 32	293,00	64
0370020011	BYN KMB ANH 11	65,50	58	0700050036	ÇTL ÇAK ANH 36	329,00	64
0370020012	BYN KMB ANH 12	70,25	58	0700050038	ÇTL ÇAK ANH 38	396,00	64
0370020013	BYN KMB ANH 13	72,00	58	0700050041	ÇTL ÇAK ANH 41	430,00	64
0370020014	BYN KMB ANH 14	77,25	58	0700050042	ÇTL ÇAK ANH 42	497,00	64
0370020015	BYN KMB ANH 15	82,25	58	0700050046	ÇTL ÇAK ANH 46	547,00	64
0370020016	BYN KMB ANH 16	88,25	58	0700050047	ÇTL ÇAK ANH 47	638,75	64
0370020017	BYN KMB ANH 17	94,25	58	0700050050	ÇTL ÇAK ANH 50	683,25	64
0370020018	BYN KMB ANH 18	105,00	58	0700050055	ÇTL ÇAK ANH 55	915,75	64
0370020019	BYN KMB ANH 19	110,50	58	0700050060	ÇTL ÇAK ANH 60	994,25	64
0370020020	BYN KMB ANH 20	116,00	58	0700050065	ÇTL ÇAK ANH 65	1.430,25	64
0370020021	BYN KMB ANH 21	130,50	58	0700050070	ÇTL ÇAK ANH 70	1.830,75	64
0370020022	BYN KMB ANH 22	149,50	58	0700050075	ÇTL ÇAK ANH 75	1.939,75	64
0370020023	BYN KMB ANH 23	182,50	58	0700050080	ÇTL ÇAK ANH 80	2.466,75	64
0370020024	BYN KMB ANH 24	182,50	58	0700050085	ÇTL ÇAK ANH 85	3.270,00	64
0370020025	BYN KMB ANH 25	182,50	58	0700050090	ÇTL ÇAK ANH 90	3.364,50	64
0370020026	BYN KMB ANH 26	214,75	58	0700050095	ÇTL ÇAK ANH 95	3.588,00	64
0370020027	BYN KMB ANH 27	214,75	58	8786001003	DĞD SET3	1.469,25	41
0370020028	BYN KMB ANH 28	214,75	58	4815006107	DĞŞK BİTS UÇ TRNV SET7	172,50	143
0370020029	BYN KMB ANH 29	239,25	58	4240170680	DĞŞK UÇ TRNV 6X80	80,50	138
0370020030	BYN KMB ANH 30	246,75	58	4170170680	DĞŞK UÇ TRNV 6X80 ELTA	70,00	196
0370020032	BYN KMB ANH 32	258,75	58	4240007102	DĞŞK UÇ TRNV TK2	138,00	138
0370020036	BYN KMB ANH 36	299,25	58	7122291275	DIŞ RLM ÇEK ÇENE 12-75	1.556,00	187
0370002112	BYN KMB ANH TK12	984,75	58	7122292211	DIŞ RLM ÇEK ÇENE 22-115	2.429,50	187
0370002117	BYN KMB ANH TK17	1.434,75	58	7122292515	DIŞ RLM ÇEK ÇENE 25-155	3.803,25	187
0370002121	BYN KMB ANH TK21	2.337,50	58	7122293022	DIŞ RLM ÇEK ÇENE 30-220	10.393,50	187
0370002108	BYN KMB ANH TK8	550,25	58	7122294028	DIŞ RLM ÇEK ÇENE 40-280	23.213,75	187
0340020008	CRC KMB ANH 08	200,50	56	7122290560	DIŞ RLM ÇEK ÇENE 5-60	1.242,00	187
0340020009	CRC KMB ANH 09	200,00	56	7122291036	DIŞ RLM ÇEK KOL 100-360	10.675,50	187
0340020010	CRC KMB ANH 10	209,75	56	7122291443	DIŞ RLM ÇEK KOL 140-435	20.865,50	187
0340020011	CRC KMB ANH 11	210,75	56	7122294011	DIŞ RLM ÇEK KOL 40-115	2.314,75	187
0340020012	CRC KMB ANH 12	228,50	56	7122295520	DIŞ RLM ÇEK KOL 55-205	3.664,00	187
0340020013	CRC KMB ANH 13	244,75	56	7122299026	DIŞ RLM ÇEK KOL 90-260	5.187,50	187
0340020014	CRC KMB ANH 14	252,25	56	4776008107	DLK TORX UÇ TRNV TK7	713,25	142
0340020015	CRC KMB ANH 15	267,25	56	4776180010	DLK TORX UÇ TRNV TR10	77,50	142
0340020016	CRC KMB ANH 16	306,25	56	4776180015	DLK TORX UÇ TRNV TR15	77,50	142
0340020017	CRC KMB ANH 17	324,25	56	4776180020	DLK TORX UÇ TRNV TR20	86,50	142
0340020018	CRC KMB ANH 18	351,50	56	4776180025	DLK TORX UÇ TRNV TR25	99,75	142
0340020019	CRC KMB ANH 19	373,25	56	4776180027	DLK TORX UÇ TRNV TR27	110,00	142
0340020021	CRC KMB ANH 21	519,25	56	4776180030	DLK TORX UÇ TRNV TR30	117,00	142
0340020022	CRC KMB ANH 22	569,50	56	4776180040	DLK TORX UÇ TRNV TR40	145,00	142
0340020024	CRC KMB ANH 24	643,25	56	4776180009	DLK TORX UÇ TRNV TR9	75,00	142
0340002110	CRC KMB ANH TK10	2.511,25	56	3852240225	DLK ZMB 225	328,50	112
0340002115	CRC KMB ANH TK15	4.901,00	56	8502346002	DMNT ATLY MASA	30.739,75	34
13000005343	CRC KMB ANH TK4	1.152,00	56				



KOD	ÜRÜN	FİYAT	SAYFA
8550348001	DMNT KÇK SRV ARB	2.894,00	30
8545341005	DMNT TARB	8.768,00	31
2350270018	DMR KSM MKS 18"	873,25	175
2350270024	DMR KSM MKS 24"	1.285,25	175
2350270030	DMR KSM MKS 30"	2.012,00	175
2350270036	DMR KSM MKS 36"	2.604,00	175
2350316104	DMR KSM MKS SHP	1.546,00	208
2350270118	DMR KSM MKS YP ÇENE 18"	474,50	202
2350270124	DMR KSM MKS YP ÇENE 24"	544,00	202
2350270130	DMR KSM MKS YP ÇENE 30"	962,75	202
2350270136	DMR KSM MKS YP ÇENE 36"	1.777,50	202
2350006104	DMR KSM MKS&SHP SET5	8.320,50	175
0551050001	DNDR KOL BORU 22-30	234,50	65
0551050002	DNDR KOL BORU 32-41	317,75	65
0551050003	DNDR KOL BORU 46-55	476,50	65
0551050004	DNDR KOL BORU 60-100	643,00	65
3850120200	DNLY 200	467,50	117
4810200645	DÜZ BİTS UÇ 0,6X4,5 (25)	8,50	144
4810205645	DÜZ BİTS UÇ 0,6X4,5 (50)	14,25	144
4810200855	DÜZ BİTS UÇ 0,8X5,5 (25)	8,50	144
4810205855	DÜZ BİTS UÇ 0,8X5,5 (50)	14,25	144
4810201265	DÜZ BİTS UÇ 1,2X6,5 (25)	8,50	144
4810205265	DÜZ BİTS UÇ 1,2X6,5 (50)	14,25	144
4860201045	DÜZ BİTS UÇ 4,5 (100)	32,25	144
4860201545	DÜZ BİTS UÇ 4,5 (150)	46,00	144
4860200745	DÜZ BİTS UÇ 4,5 (75)	21,50	144
4860201055	DÜZ BİTS UÇ 5,5 (100)	32,25	144
4860201555	DÜZ BİTS UÇ 5,5 (150)	46,00	144
4860200755	DÜZ BİTS UÇ 5,5 (75)	21,50	144
4860201065	DÜZ BİTS UÇ 6,5 (100)	32,25	144
4860201565	DÜZ BİTS UÇ 6,5 (150)	46,00	144
4860200765	DÜZ BİTS UÇ 6,5 (75)	21,50	144
4810000645	DÜZ BİTS UÇ TK10 0,6X4,5	85,00	144
4810000855	DÜZ BİTS UÇ TK10 0,8X5,5	85,00	144
4810001265	DÜZ BİTS UÇ TK10 1,2X6,5	85,00	144
5500230100	DÜZ KSK 100	75,00	155
5500230125	DÜZ KSK 125	90,25	155
5500230150	DÜZ KSK 150	116,00	155
5500230175	DÜZ KSK 175	130,75	155
5500230200	DÜZ KSK 200	182,00	155
5500230250	DÜZ KSK 250	223,75	155
5500230300	DÜZ KSK 300	358,50	155
5500231250	DÜZ KSK KLKN İZL 250	284,75	155
5500231300	DÜZ KSK KLKN İZL 300	415,00	155
5550240002	DÜZ PİM ZMB 02	107,00	156
5550240003	DÜZ PİM ZMB 03	107,00	156
5550240004	DÜZ PİM ZMB 04	108,75	156
5550240005	DÜZ PİM ZMB 05	108,75	156
5550240006	DÜZ PİM ZMB 06	109,75	156
5550240007	DÜZ PİM ZMB 07	114,25	156
5550240008	DÜZ PİM ZMB 08	122,25	156
5550240009	DÜZ PİM ZMB 09	124,00	156
5550240010	DÜZ PİM ZMB 10	125,25	156
5550240105	DÜZ PİM ZMB KKPL 05	95,50	156
5550001006	DÜZ PİM ZMB TK6	670,75	156
3301120140	DÜZ UÇ DIŞ SGM PNS YAY 140	264,00	111
3301120180	DÜZ UÇ DIŞ SGM PNS YAY 180	278,50	111
3301120225	DÜZ UÇ DIŞ SGM PNS YAY 225	348,00	111
3301120295	DÜZ UÇ DIŞ SGM PNS YAY 295	590,00	111
3321120140	DÜZ UÇ İÇ SGM PNS YAYZ 140	243,25	111
3321120180	DÜZ UÇ İÇ SGM PNS YAYZ 180	256,50	111
3321120225	DÜZ UÇ İÇ SGM PNS YAYZ 225	319,25	111
3321120310	DÜZ UÇ İÇ SGM PNS YAYZ 310	548,00	111
1300005122	DVM TEL KSM MKS 210	652,50	177
3311120125	EĞRİ UÇ DIŞ SGM PNS YAY 125	295,25	111
3311120170	EĞRİ UÇ DIŞ SGM PNS YAY 170	310,75	111
3311120210	EĞRİ UÇ DIŞ SGM PNS YAY 210	357,25	111

KOD	ÜRÜN	FİYAT	SAYFA
3311120275	EĞRİ UÇ DIŞ SGM PNS YAY 275	619,50	111
3331120130	EĞRİ UÇ İÇ SGM PNS YAYZ 130	261,50	111
3331120170	EĞRİ UÇ İÇ SGM PNS YAYZ 170	275,25	111
3331120210	EĞRİ UÇ İÇ SGM PNS YAYZ 210	343,50	111
3331120290	EĞRİ UÇ İÇ SGM PNS YAYZ 290	589,50	111
3553140150	ELKTRO DÜZ UÇ KRGB 150	289,25	115
3565002104	ELKTRO KRGB SET4	1.158,00	116
3554140150	ELKTRO KRGB UB 150	289,25	115
3560002104	ELKTRO KSK&PNS SET4	1.199,25	116
3557140125	ELKTRO PNS 125	290,25	116
3555140150	ELKTRO SVR UÇ DÜZ KRGB 150	289,25	115
3556140150	ELKTRO SVR UÇ EĞRİ KRGB 150	289,25	116
3551140125	ELKTRO TPKSK 125	299,25	115
3550140125	ELKTRO YNKS 125	320,50	115
3552140125	ELKTRO YVRL UÇ KRGB 125	290,25	115
6712270210	ELMA MKS 210	550,50	178
5810251000	EMNY ÇKÇ 1000GR	401,00	158
5810251500	EMNY ÇKÇ 1500GR	554,75	158
5810252000	EMNY ÇKÇ 2000GR	685,25	158
2401110240	FORT PNS 240 ELTA	332,50	195
2415110240	FORT PNS YAY 240	487,50	102
6230260300	GRES POMP KAVAL BORU 300CC	362,00	167
6230260500	GRES POMP KAVAL BORU 500CC	445,75	167
6230263300	GRES POMP YP HRTM 300CC	47,25	204
6230263500	GRES POMP YP HRTM 500CC	86,50	204
6230262500	GRES POMP YP UÇ 300&500CC	41,50	204
3420120220	HRTM KLPÇ PNS 220	469,50	112
0589850283	HSS TSTR YP LAMA 13X0,65X18	44,00	204
5010230006	ISKPL DÜZ 06	125,25	155
5011230006	ISKPL DÜZ 06 ELTA	103,75	199
5010230008	ISKPL DÜZ 08	133,75	155
5011230008	ISKPL DÜZ 08 ELTA	110,00	199
5010230010	ISKPL DÜZ 10	141,25	155
5011230010	ISKPL DÜZ 10 ELTA	116,25	199
5010230012	ISKPL DÜZ 12	155,00	155
5011230012	ISKPL DÜZ 12 ELTA	127,50	199
5010230014	ISKPL DÜZ 14	160,25	155
5011230014	ISKPL DÜZ 14 ELTA	132,00	199
5010230016	ISKPL DÜZ 16	171,50	155
5011230016	ISKPL DÜZ 16 ELTA	141,00	199
5010230018	ISKPL DÜZ 18	186,00	155
5011230018	ISKPL DÜZ 18 ELTA	153,00	199
5010230020	ISKPL DÜZ 20	206,75	155
5011230020	ISKPL DÜZ 20 ELTA	169,75	199
5010230022	ISKPL DÜZ 22	224,00	155
5011230022	ISKPL DÜZ 22 ELTA	184,50	199
5010230024	ISKPL DÜZ 24	242,00	155
5011230024	ISKPL DÜZ 24 ELTA	198,75	199
5010230026	ISKPL DÜZ 26	250,75	155
5011230026	ISKPL DÜZ 26 ELTA	206,25	199
5010230030	ISKPL DÜZ 30	267,75	155
5011230030	ISKPL DÜZ 30 ELTA	220,00	199
5010008106	ISKPL TK6	1.020,75	155
7120293575	İÇ RLM ÇEK KOL 35-75	818,25	186
7120296013	İÇ RLM ÇEK KOL 60-130	1.658,00	186
7120291013	İÇ RLM ÇEK PENS 10-13 MDL-A	744,25	186
7120291317	İÇ RLM ÇEK PENS 13-17 MDL-A	744,25	186
7120291419	İÇ RLM ÇEK PENS 14-19 MDL-A	762,50	186
7120291621	İÇ RLM ÇEK PENS 16-21 MDL-A	762,50	186
7120291823	İÇ RLM ÇEK PENS 18-23 MDL-A	912,75	186
7120292025	İÇ RLM ÇEK PENS 20-25 MDL-A	963,50	186
7120292530	İÇ RLM ÇEK PENS 25-30 MDL-A	1.003,75	186
7120292540	İÇ RLM ÇEK PENS 25-40 MDL-B	1.626,50	186
7120293037	İÇ RLM ÇEK PENS 30-37 MDL-A	1.162,75	186
7120293542	İÇ RLM ÇEK PENS 35-42 MDL-A	1.222,00	186
7120293845	İÇ RLM ÇEK PENS 38-45 MDL-A	1.288,25	186
7120294350	İÇ RLM ÇEK PENS 43-50 MDL-A	1.464,75	186

KOD	ÜRÜN	FİYAT	SAYFA	KOD	ÜRÜN	FİYAT	SAYFA
7120290507	İÇ RLM ÇEK PENS 5-7 MDL-A	803,25	186	0320020027	KMB ANH KB 27	187,00	53
7120290709	İÇ RLM ÇEK PENS 7-9 MDL-A	803,25	186	0320020028	KMB ANH KB 28	187,00	53
7120290912	İÇ RLM ÇEK PENS 9-12 MDL-A	744,25	186	0320020029	KMB ANH KB 29	214,00	53
7300301012	İŞKN 100X12	818,00	172	0320020030	KMB ANH KB 30	214,00	53
7300303012	İŞKN 30X12	534,50	172	0320020032	KMB ANH KB 32	225,00	53
7300304012	İŞKN 40X12	631,50	172	0320020034	KMB ANH KB 34	235,00	53
7300305012	İŞKN 50X12	647,50	172	0320020055	KMB ANH KB 5,5	40,00	53
7300306012	İŞKN 60X12	675,75	172	032002112	KMB ANH KB TK12	854,00	53
7300308012	İŞKN 80X12	716,75	172	032002117	KMB ANH KB TK17	1.242,25	53
7300316150	İŞKN SHP	1.329,00	208	032002121	KMB ANH KB TK21	2.027,00	53
1300005248	KAMP BLT 600GR	606,50	159	032002108	KMB ANH KB TK8	477,50	53
8550348002	KAPA KÇK DMNT SRV ARB	3.337,50	30	0350020006	KMB ANH SB 06 ELTA	34,50	191
14000004238	KATLANIR BDM TSTR 120	355,00	164	0350020007	KMB ANH SB 07 ELTA	36,75	191
0375250625	KBLO SYRC (T 6/300 - Ç 1,5/25)	253,50	163	0350020008	KMB ANH SB 08 ELTA	39,75	191
0375050020	KBLO SYRC 8-28	278,50	163	0350020009	KMB ANH SB 09 ELTA	41,00	191
0375550625	KBLO SYRC YP BÇK	64,00	203	0350020010	KMB ANH SB 10 ELTA	46,25	191
6850280322	KÇK BORU KSC	256,50	179	0350020011	KMB ANH SB 11 ELTA	47,75	191
7310301005	KÇK İŞKN 10X5	230,00	172	0350020012	KMB ANH SB 12 ELTA	50,75	191
7310301505	KÇK İŞKN 15X5	242,25	172	0350020013	KMB ANH SB 13 ELTA	51,50	191
7310302005	KÇK İŞKN 20X5	251,25	172	0350020014	KMB ANH SB 14 ELTA	55,75	191
7310302505	KÇK İŞKN 25X5	262,00	172	0350020015	KMB ANH SB 15 ELTA	59,50	191
7310303005	KÇK İŞKN 30X5	271,25	172	0350020016	KMB ANH SB 16 ELTA	64,00	191
4540190190	KLİPS SÖKM TRNV	189,25	139	0350020017	KMB ANH SB 17 ELTA	68,50	191
4500172560	KLMNS DÜZ UÇ TRNV 2,5X60	35,75	138	0350020018	KMB ANH SB 18 ELTA	76,00	191
4500172580	KLMNS DÜZ UÇ TRNV 2,5X80	37,50	138	0350020019	KMB ANH SB 19 ELTA	80,00	191
4500173510	KLMNS DÜZ UÇ TRNV 3,5X100	50,00	138	0350020020	KMB ANH SB 20 ELTA	81,50	191
4500173100	KLMNS DÜZ UÇ TRNV 3X100	48,50	138	0350020021	KMB ANH SB 21 ELTA	94,75	191
4500173125	KLMNS DÜZ UÇ TRNV 3X125	64,00	138	0350020022	KMB ANH SB 22 ELTA	108,25	191
4500170380	KLMNS DÜZ UÇ TRNV 3X80	39,75	138	0350020024	KMB ANH SB 24 ELTA	132,25	191
4500174100	KLMNS DÜZ UÇ TRNV 4X100	50,00	138	0350020027	KMB ANH SB 27 ELTA	155,75	191
4500174125	KLMNS DÜZ UÇ TRNV 4X125	67,25	138	0350020030	KMB ANH SB 30 ELTA	178,75	191
4500174150	KLMNS DÜZ UÇ TRNV 4X150	73,25	138	0350020032	KMB ANH SB 32 ELTA	187,25	191
4500170480	KLMNS DÜZ UÇ TRNV 4X80	40,75	138	0350002112	KMB ANH SB TK12 ELTA	713,00	191
4500008106	KLMNS DÜZ&YLD UÇ TRNV SET6	327,75	138	0350002117	KMB ANH SB TK17 ELTA	1.036,50	191
4530171060	KLMNS TORX UÇ TRNV T10	50,25	139	0350002121	KMB ANH SB TK21 ELTA	1.690,50	191
4530170560	KLMNS TORX UÇ TRNV T5	48,50	139	0350002108	KMB ANH SB TK8 ELTA	398,25	191
4530170660	KLMNS TORX UÇ TRNV T6	48,50	139	0330020005	KMB ANH UB 05	46,25	54
4530170760	KLMNS TORX UÇ TRNV T7	50,25	139	0330020006	KMB ANH UB 06	46,25	54
4530170860	KLMNS TORX UÇ TRNV T8	50,25	139	0330020007	KMB ANH UB 07	46,25	54
4530170960	KLMNS TORX UÇ TRNV T9	50,25	139	0330020008	KMB ANH UB 08	54,00	54
4530001006	KLMNS TORX UÇ TRNV TK6	298,00	139	0330020009	KMB ANH UB 09	54,75	54
4520180360	KLMNS YLD UÇ TRNV 3X60	42,00	138	0331020025	KMB ANH UB 1 SAE	223,75	55
4520184150	KLMNS YLD UÇ TRNV 4X150	80,25	138	0331020013	KMB ANH UB 1/2 SAE	90,50	55
4520180480	KLMNS YLD UÇ TRNV 4X80	60,25	138	0331020006	KMB ANH UB 1/4 SAE	57,75	55
0637550010	KLPÇ AYR YAĞ FLT SÖKM 100	52,00	203	0330020010	KMB ANH UB 10	60,50	54
0320020005	KMB ANH KB 05	40,00	53	0330020011	KMB ANH UB 11	64,00	54
0320020006	KMB ANH KB 06	41,50	53	0331020017	KMB ANH UB 11/16 SAE	115,50	55
0320020007	KMB ANH KB 07	44,00	53	0331020027	KMB ANH UB 1-1/16 SAE	261,75	55
0320020008	KMB ANH KB 08	48,00	53	0331020038	KMB ANH UB 1-1/2 SAE	379,75	55
0320020009	KMB ANH KB 09	49,00	53	0331020032	KMB ANH UB 1-1/4 SAE	314,25	55
0320020010	KMB ANH KB 10	55,25	53	0331020028	KMB ANH UB 1-1/8 SAE	261,75	55
0320020011	KMB ANH KB 11	56,75	53	0331020046	KMB ANH UB 1-13/16 SAE	547,00	55
0320020012	KMB ANH KB 12	60,50	53	0330020012	KMB ANH UB 12	64,00	54
0320020013	KMB ANH KB 13	61,75	53	0330020013	KMB ANH UB 13	71,75	54
0320020014	KMB ANH KB 14	67,00	53	0331020021	KMB ANH UB 13/16 SAE	158,75	55
0320020015	KMB ANH KB 15	71,50	53	0331020030	KMB ANH UB 1-3/16 SAE	299,75	55
0320020016	KMB ANH KB 16	76,75	53	0331020035	KMB ANH UB 1-3/8 SAE	345,25	55
0320020017	KMB ANH KB 17	82,00	53	0330020014	KMB ANH UB 14	74,50	54
0320020018	KMB ANH KB 18	91,25	53	0330020015	KMB ANH UB 15	79,75	54
0320020019	KMB ANH KB 19	96,00	53	0331020024	KMB ANH UB 15/16 SAE	223,75	55
0320020020	KMB ANH KB 20	98,00	53	0331020033	KMB ANH UB 1-5/16 SAE	314,25	55
0320020021	KMB ANH KB 21	113,50	53	0331020041	KMB ANH UB 1-5/8 SAE	402,50	55
0320020022	KMB ANH KB 22	129,50	53	0330020016	KMB ANH UB 16	80,50	54
0320020023	KMB ANH KB 23	129,50	53	0330020017	KMB ANH UB 17	91,25	54
0320020024	KMB ANH KB 24	158,75	53	0331020036	KMB ANH UB 1-7/16 SAE	345,25	55
0320020025	KMB ANH KB 25	158,75	53	0330020018	KMB ANH UB 18	98,50	54
0320020026	KMB ANH KB 26	187,00	53	0330020019	KMB ANH UB 19	107,00	54

KOD	ÜRÜN	FİYAT	SAYFA
0331020015	KMB ANH UB 19/32 SAE	100,75	55
0331020050	KMB ANH UB 2 SAE	741,75	55
0330020020	KMB ANH UB 20	113,75	54
0330020021	KMB ANH UB 21	121,00	54
0330020022	KMB ANH UB 22	144,25	54
0330020023	KMB ANH UB 23	176,00	54
0330020024	KMB ANH UB 24	176,00	54
0330020025	KMB ANH UB 25	176,00	54
0331020020	KMB ANH UB 25/32 SAE	143,75	55
0330020026	KMB ANH UB 26	207,25	54
0330020027	KMB ANH UB 27	207,25	54
0330020028	KMB ANH UB 28	207,25	54
0330020029	KMB ANH UB 29	207,25	54
0331020005	KMB ANH UB 3/16 SAE	55,25	55
0331020019	KMB ANH UB 3/4 SAE	134,50	55
0331020010	KMB ANH UB 3/8 SAE	76,50	55
0330020030	KMB ANH UB 30	238,00	54
0330020032	KMB ANH UB 32	249,50	54
0330020034	KMB ANH UB 34	254,50	54
0330020036	KMB ANH UB 36	288,25	54
0330020038	KMB ANH UB 38	295,00	54
0330020041	KMB ANH UB 41	335,75	54
0330020046	KMB ANH UB 46	456,00	54
0330020055	KMB ANH UB 5,5	46,25	54
0331020008	KMB ANH UB 5/16 SAE	67,00	55
0331020016	KMB ANH UB 5/8 SAE	108,25	55
0330020050	KMB ANH UB 50	618,25	54
0331020011	KMB ANH UB 7/16 SAE	80,25	55
0331020022	KMB ANH UB 7/8 SAE	182,75	55
0331020014	KMB ANH UB 9/16 SAE	95,00	55
0330020112	KMB ANH UB TK12	946,25	54
0331002112	KMB ANH UB TK12 SAE	1.556,50	55
0330020117	KMB ANH UB TK17	1.372,00	54
0331002117	KMB ANH UB TK17 SAE	2.420,25	55
0331002120	KMB ANH UB TK20 SAE	3.310,50	55
0330020121	KMB ANH UB TK21	2.242,75	54
0330020108	KMB ANH UB TK8	531,75	54
0331002108	KMB ANH UB TK8 SAE	767,50	55
6740270140	KMB MKS 140	322,50	177
6740270190	KMB MKS 190	378,25	177
0588750150	KMPS 150	978,00	164
0860052528	KNC ANH 4GEN UÇ 25/28	123,00	65
0860053032	KNC ANH 4GEN UÇ 30/32	123,00	65
0860053436	KNC ANH 4GEN UÇ 34/36	133,00	65
0860054042	KNC ANH 4GEN UÇ 40/42	133,00	65
0860054550	KNC ANH 4GEN UÇ 45/50	154,00	65
0860055255	KNC ANH 4GEN UÇ 52/55	154,00	65
0860055862	KNC ANH 4GEN UÇ 58/62	185,75	65
0860056875	KNC ANH 4GEN UÇ 68/75	185,75	65
0860058090	KNC ANH 4GEN UÇ 80/90	242,50	65
0860059510	KNC ANH 4GEN UÇ 95/100	242,50	65
5545240002	KNK PİM ZMB 02	74,75	156
5545240003	KNK PİM ZMB 03	81,25	156
5545240004	KNK PİM ZMB 04	91,50	156
5545240005	KNK PİM ZMB 05	93,25	156
5545240006	KNK PİM ZMB 06	137,50	156
5545240007	KNK PİM ZMB 07	143,25	156
5545240008	KNK PİM ZMB 08	148,75	156
5545240009	KNK PİM ZMB 09	152,25	156
5545240010	KNK PİM ZMB 10	155,25	156
5545240012	KNK PİM ZMB 12	162,25	156
5545240103	KNK PİM ZMB KKPL 03	85,00	156
4550170135	KNT KLM DÜZ UÇ 135	47,00	131
4550170190	KNT KLM DÜZ UÇ 190	60,00	131
4560180135	KNT KLM YLD UÇ 135	52,00	131
4560180190	KNT KLM YLD UÇ 190	71,00	131
0375150012	KOAK KBLO SYRC	361,50	163

KOD	ÜRÜN	FİYAT	SAYFA
2515110270	KPRT AYR PNS 270	576,50	104
6210270250	KPRT MKS 250 SAĞ YAY	434,00	176
6211270250	KPRT MKS 250 SOL YAY	434,00	176
6210270275	KPRT MKS 275 SAĞ YAY	474,75	176
6211270275	KPRT MKS 275 SOL YAY	474,75	176
6210270300	KPRT MKS 300 SAĞ YAY	541,25	176
6211270300	KPRT MKS 300 SOL YAY	541,25	176
3220133140	KRAFT DÜZ UÇ KRGB 140	273,25	106
3220133160	KRAFT DÜZ UÇ KRGB 160	308,25	106
3220133180	KRAFT DÜZ UÇ KRGB 180	339,25	106
3220133200	KRAFT DÜZ UÇ KRGB 200	359,50	106
4100171125	KRAFT DÜZ UÇ TRNV 11X250	185,25	132
4100170340	KRAFT DÜZ UÇ TRNV 3X40	39,50	132
4100170380	KRAFT DÜZ UÇ TRNV 3X80	42,00	132
4100174100	KRAFT DÜZ UÇ TRNV 4X100	52,50	132
4100174300	KRAFT DÜZ UÇ TRNV 4X300	129,00	132
4100170480	KRAFT DÜZ UÇ TRNV 4X80	45,25	132
4100175100	KRAFT DÜZ UÇ TRNV 5X100	61,00	132
4100175125	KRAFT DÜZ UÇ TRNV 5X125	69,75	132
4100175150	KRAFT DÜZ UÇ TRNV 5X150	76,25	132
4100175250	KRAFT DÜZ UÇ TRNV 5X250	144,25	132
4100175350	KRAFT DÜZ UÇ TRNV 5X350	162,75	132
4100170580	KRAFT DÜZ UÇ TRNV 5X80	55,50	132
4100176100	KRAFT DÜZ UÇ TRNV 6X100	62,50	132
4100176125	KRAFT DÜZ UÇ TRNV 6X125	71,75	132
4100176150	KRAFT DÜZ UÇ TRNV 6X150	78,75	132
4100176175	KRAFT DÜZ UÇ TRNV 6X175	101,00	132
4100176350	KRAFT DÜZ UÇ TRNV 6X350	172,25	132
4100177125	KRAFT DÜZ UÇ TRNV 7X125	79,75	132
4100177150	KRAFT DÜZ UÇ TRNV 7X150	92,25	132
4100177175	KRAFT DÜZ UÇ TRNV 7X175	105,75	132
4100178150	KRAFT DÜZ UÇ TRNV 8X150	104,75	132
4100178175	KRAFT DÜZ UÇ TRNV 8X175	111,75	132
4100178200	KRAFT DÜZ UÇ TRNV 8X200	136,75	132
4100179200	KRAFT DÜZ UÇ TRNV 9X200	145,75	132
4100008108	KRAFT DÜZ UÇ TRNV TK8	483,50	132
4100008107	KRAFT DÜZ&YLD UÇ TRNV SET7	429,25	133
3225133160	KRAFT EĞRİ UÇ KRGB 160	317,75	107
3225133180	KRAFT EĞRİ UÇ KRGB 180	349,00	107
3225133200	KRAFT EĞRİ UÇ KRGB 200	383,75	107
3020123160	KRAFT KMB PNS 160	275,25	105
3020123180	KRAFT KMB PNS 180	307,50	105
3020123200	KRAFT KMB PNS 200	347,50	105
4110175525	KRAFT TPÇ DÜZ UÇ TRNV 5,5X25	45,50	134
4110175540	KRAFT TPÇ DÜZ UÇ TRNV 5,5X40	61,50	134
4110176525	KRAFT TPÇ DÜZ UÇ TRNV 6,5X25	50,75	134
4110176540	KRAFT TPÇ DÜZ UÇ TRNV 6,5X40	69,75	134
4130184525	KRAFT TPÇ YLD UÇ TRNV 4,5X25	48,50	134
4130184540	KRAFT TPÇ YLD UÇ TRNV 4,5X40	61,25	134
4130180625	KRAFT TPÇ YLD UÇ TRNV 6X25	51,00	134
4130180640	KRAFT TPÇ YLD UÇ TRNV 6X40	69,00	134
4120181200	KRAFT YLD UÇ TRNV 10X200	225,75	133
4120180360	KRAFT YLD UÇ TRNV 3X60	44,50	133
4120185100	KRAFT YLD UÇ TRNV 4,5X100	71,25	133
4120185150	KRAFT YLD UÇ TRNV 4,5X150	85,25	133
4120185300	KRAFT YLD UÇ TRNV 4,5X300	201,50	133
4120184580	KRAFT YLD UÇ TRNV 4,5X80	64,00	133
4120186100	KRAFT YLD UÇ TRNV 6X100	77,00	133
4120186150	KRAFT YLD UÇ TRNV 6X150	92,25	133
4120186200	KRAFT YLD UÇ TRNV 6X200	119,75	133
4120186300	KRAFT YLD UÇ TRNV 6X300	208,25	133
4120188150	KRAFT YLD UÇ TRNV 8X150	146,00	133
4120008106	KRAFT YLD UÇ TRNV TK6	434,25	133
3700163140	KRAFT YNKS 140	282,00	108
3700163160	KRAFT YNKS 160	338,75	108
3700163180	KRAFT YNKS 180	394,50	108
0588150013	KROM ŞRT MT3	134,00	163

KOD	ÜRÜN	FİYAT	SAYFA	KOD	ÜRÜN	FİYAT	SAYFA
0588150015	KROM ŞRT MT5	151,25	163	4770190040	LKM UÇ TRNV 04	116,25	140
3800150160	KRPTN 160	231,25	117	4770190050	LKM UÇ TRNV 05	116,25	140
3801150160	KRPTN 160 ELTA	187,00	196	4770190060	LKM UÇ TRNV 06	116,25	140
3800150180	KRPTN 180	239,25	117	4770190070	LKM UÇ TRNV 07	125,00	140
3801150180	KRPTN 180 ELTA	201,75	196	4770190080	LKM UÇ TRNV 08	125,00	140
3800150200	KRPTN 200	319,00	117	4770190090	LKM UÇ TRNV 09	134,75	140
3801150200	KRPTN 200 ELTA	252,25	196	4770190100	LKM UÇ TRNV 10	134,75	140
3800150250	KRPTN 250	347,50	117	4770190110	LKM UÇ TRNV 11	147,25	140
5600006106	KSK&ZMB SET6	612,50	157	4770190120	LKM UÇ TRNV 12	157,75	140
6400250600	KSR 400GR	405,00	159	4770190130	LKM UÇ TRNV 13	170,00	140
6400250001	KSR YP SAP 400GR	58,25	203	4770190140	LKM UÇ TRNV 14	188,00	140
4912000007	KST ALLEN ANH 1,5-6	275,00	150	4770190055	LKM UÇ TRNV 5,5	116,25	140
4912003107	KST ALLEN ANH 2,5-10	434,00	150	4770008108	LKM UÇ TRNV TK8	1.110,75	140
4915006106	KST ALLEN ANH 2,5-8 ELTA	275,00	199	5870250400	LSTK ÇKÇ 400GR	385,50	158
0600011010	KURB ANH 10"	371,75	65	6350260300	LVY OLK 300	134,25	167
0601010010	KURB ANH 10" ELTA	309,00	192	6350260400	LVY OLK 400	169,25	167
0600011012	KURB ANH 12"	513,75	65	6351260400	LVY OLK 400 ELTA	129,50	199
0601010012	KURB ANH 12" ELTA	408,25	192	6350260500	LVY OLK 500	235,25	167
0600011015	KURB ANH 15"	805,00	65	6351260500	LVY OLK 500 ELTA	189,75	199
0600011006	KURB ANH 6"	230,75	65	6350260600	LVY OLK 600	287,25	167
0600011008	KURB ANH 8"	288,50	65	6351260600	LVY OLK 600 ELTA	247,25	199
0601010008	KURB ANH 8" ELTA	205,25	192	6360260600	LVY OLK KVRK UÇ 600	317,50	167
0600010210	KURB ANH YP SMN 10"	28,25	202	6225260200	MDN YAĞ FLEX UÇ 200CC	149,25	165
0600010212	KURB ANH YP SMN 12"	38,75	202	6225260300	MDN YAĞ FLEX UÇ 300CC	168,00	165
0600010215	KURB ANH YP SMN 15"	55,75	202	6225260500	MDN YAĞ FLEX UÇ 500CC	184,25	165
0600010206	KURB ANH YP SMN 6"	18,00	202	5865251000	MDRG 1000GR	367,50	159
0600010208	KURB ANH YP SMN 8"	21,25	202	5865251500	MDRG 1500GR	438,75	159
0600010310	KURB ANH YP VIDA 10"	8,50	202	5865250001	MDRG YP SAP&KAMA 1000GR	54,50	203
0600010312	KURB ANH YP VIDA 12"	11,25	202	5865250002	MDRG YP SAP&KAMA 1500GR	59,75	203
0600010315	KURB ANH YP VIDA 15"	14,25	202	0345020008	MFSL CRC KMB ANH 08	331,50	57
0600010306	KURB ANH YP VIDA 6"	4,50	202	0345020009	MFSL CRC KMB ANH 09	338,25	57
0600010308	KURB ANH YP VIDA 8"	7,00	202	0345020010	MFSL CRC KMB ANH 10	351,75	57
0600010410	KURB ANH YP YAY 10"	3,25	202	0345020011	MFSL CRC KMB ANH 11	362,75	57
0600010412	KURB ANH YP YAY 12"	3,25	202	0345020012	MFSL CRC KMB ANH 12	383,50	57
0600010415	KURB ANH YP YAY 15"	3,25	202	0345020013	MFSL CRC KMB ANH 13	400,00	57
0600010406	KURB ANH YP YAY 6"	3,25	202	0345020014	MFSL CRC KMB ANH 14	420,50	57
0600010408	KURB ANH YP YAY 8"	3,25	202	0345020015	MFSL CRC KMB ANH 15	441,25	57
1850071120	KVN ANH MİL 10X120	42,50	95	0345020016	MFSL CRC KMB ANH 16	480,25	57
1850071200	KVN ANH MİL 10X200	48,00	95	0345020017	MFSL CRC KMB ANH 17	486,50	57
1850075125	KVN ANH MİL 5X125	24,50	95	0345020018	MFSL CRC KMB ANH 18	523,75	57
1850078180	KVN ANH MİL 8X180	37,50	95	0345020019	MFSL CRC KMB ANH 19	547,25	57
0741650001	KVRK UÇ FRÇ PLS SAP 270	50,75	169	0345020112	MFSL CRC KMB ANH TK12	5.067,25	57
6800270180	KYM MKS DÜZ 180	352,25	177	1855080008	MFSL T KOL LKM 08	711,50	96
6801270180	KYM MKS EĞRİ 180	385,25	177	1855080010	MFSL T KOL LKM 10	865,00	96
2513110280	KYNK AYR PNS BORU AĞZ 280	726,25	104	1855080012	MFSL T KOL LKM 12	865,00	96
2512110200	KYNK AYR PNS DÜZ AĞZ 200	726,25	104	1855080013	MFSL T KOL LKM 13	865,00	96
0637350140	KYŞ YAĞ FLT SÖKM 60-140	514,00	168	1855080017	MFSL T KOL LKM 17	963,50	96
5700240003	KYŞ ZMB 03	64,00	157	1855080019	MFSL T KOL LKM 19	1.224,75	96
5700240004	KYŞ ZMB 04	67,00	157	0375350054	MKNK KBLO SYRC 0,5-4	476,25	163
5700240005	KYŞ ZMB 05	72,75	157	0741050010	MKR UZT KBLO MT10	1.013,75	169
5700240006	KYŞ ZMB 06	74,25	157	0741050025	MKR UZT KBLO MT25	1.791,50	169
5700240007	KYŞ ZMB 07	81,75	157	0741050050	MKR UZT KBLO MT50	3.577,25	169
5700240008	KYŞ ZMB 08	86,75	157	7400000100	MNGN (DNR TBL DHL) 100	2.976,00	171
5700240009	KYŞ ZMB 09	96,75	157	7400000125	MNGN (DNR TBL DHL) 125	4.059,75	171
5700240010	KYŞ ZMB 10	103,25	157	7400000150	MNGN (DNR TBL DHL) 150	5.133,75	171
5700240011	KYŞ ZMB 11	111,00	157	7400000175	MNGN (DNR TBL DHL) 175	6.208,00	171
5700240012	KYŞ ZMB 12	132,75	157	7400300100	MNGN 100	2.299,00	171
5700240013	KYŞ ZMB 13	139,75	157	7400300125	MNGN 125	3.165,25	171
5700240014	KYŞ ZMB 14	153,50	157	7400300150	MNGN 150	4.048,00	171
5700240015	KYŞ ZMB 15	176,00	157	7400300175	MNGN 175	4.980,50	171
5700240016	KYŞ ZMB 16	192,75	157	7401300100	MNGN DNR TBL 100	677,00	171
5700240017	KYŞ ZMB 17	210,75	157	7401300125	MNGN DNR TBL 125	894,50	171
5700240018	KYŞ ZMB 18	229,75	157	7401300150	MNGN DNR TBL 150	1.085,75	171
5700240019	KYŞ ZMB 19	249,75	157	7401300175	MNGN DNR TBL 175	1.227,50	171
5700240020	KYŞ ZMB 20	266,00	157	8004316004	MNGN SHP	1.647,50	209
5700002110	KYŞ ZMB TK10	890,25	157	0325020010	MNT ANH 10	70,50	52
5700002112	KYŞ ZMB TK12	1.183,50	157	0325020013	MNT ANH 13	78,75	52

KOD	ÜRÜN	FİYAT	SAYFA
0325020017	MNT ANH 17	104,25	52
0325020019	MNT ANH 19	122,00	52
0325020020	MNT ANH 20	124,25	52
0325020021	MNT ANH 21	144,50	52
0325020022	MNT ANH 22	165,50	52
4780196120	MNY BİTS TUTC TRNV 6,3X120	150,00	142
4785196330	MNY BİTS TUTC TRNV 6,3X30	81,75	142
4788196160	MNY BİTS TUTC TRNV FLEX SNG 6,3X160	311,00	143
8779008741	MOTOSİKLET BKM SET42	1.823,50	41
7030291212	MSTR ÇEK 2KOL 12X12	725,50	184
7030291616	MSTR ÇEK 2KOL 16X16	1.091,75	184
7030292320	MSTR ÇEK 2KOL 23X20	1.484,25	184
7030290808	MSTR ÇEK 2KOL 8X8	351,75	184
7040291212	MSTR ÇEK 3KOL 12X12	986,25	184
7040291616	MSTR ÇEK 3KOL 16X16	1.450,25	184
7040292320	MSTR ÇEK 3KOL 23X20	1.952,75	184
7040290808	MSTR ÇEK 3KOL 8X8	674,00	184
7030291222	MSTR ÇEK YP KOL 12X12	119,75	205
7030291622	MSTR ÇEK YP KOL 16X16	213,75	205
7030292322	MSTR ÇEK YP KOL 23X20	290,75	205
7030290822	MSTR ÇEK YP KOL 8X8	86,25	205
7030291244	MSTR ÇEK YP MİL 12X12	172,50	205
7030291644	MSTR ÇEK YP MİL 16X16	190,50	205
7030292344	MSTR ÇEK YP MİL 23X20	261,00	205
7030290844	MSTR ÇEK YP MİL 8X8	117,25	205
4555170165	MSTR KNT KLM DÜZ UÇ 165	65,00	131
6410250800	NCK 800GR	733,50	159
6410250001	NCK YP SAP&KAMA 800GR	175,75	203
5540244120	NKT ZMB 4X120	86,75	156
5540245120	NKT ZMB 5X120	102,25	156
5540245150	NKT ZMB 5X150	113,25	156
5540240412	NKT ZMB KKPL 4X120	85,75	156
3220132140	OPAK DÜZ UÇ KRGB 140	221,25	106
3220132160	OPAK DÜZ UÇ KRGB 160	250,25	106
3221131160	OPAK DÜZ UÇ KRGB 160 ELTA	186,50	196
3220132180	OPAK DÜZ UÇ KRGB 180	275,00	106
3220132200	OPAK DÜZ UÇ KRGB 200	291,50	106
3221131200	OPAK DÜZ UÇ KRGB 200 ELTA	213,50	196
4300170380	OPAK DÜZ UÇ TRNV 3X80	37,00	136
4150170380	OPAK DÜZ UÇ TRNV 3X80 ELTA	30,50	197
4300174100	OPAK DÜZ UÇ TRNV 4X100	45,50	136
4150174100	OPAK DÜZ UÇ TRNV 4X100 ELTA	37,50	197
4300170480	OPAK DÜZ UÇ TRNV 4X80	38,25	136
4150170480	OPAK DÜZ UÇ TRNV 4X80 ELTA	35,00	197
4300175100	OPAK DÜZ UÇ TRNV 5X100	55,00	136
4150175100	OPAK DÜZ UÇ TRNV 5X100 ELTA	45,00	197
4300175125	OPAK DÜZ UÇ TRNV 5X125	64,00	136
4150175125	OPAK DÜZ UÇ TRNV 5X125 ELTA	52,00	197
4300176100	OPAK DÜZ UÇ TRNV 6X100	57,25	136
4150176100	OPAK DÜZ UÇ TRNV 6X100 ELTA	47,00	197
4300176125	OPAK DÜZ UÇ TRNV 6X125	65,25	136
4150176125	OPAK DÜZ UÇ TRNV 6X125 ELTA	53,25	197
4300176150	OPAK DÜZ UÇ TRNV 6X150	71,25	136
4150176150	OPAK DÜZ UÇ TRNV 6X150 ELTA	58,75	197
4300177125	OPAK DÜZ UÇ TRNV 7X125	73,00	136
4300177150	OPAK DÜZ UÇ TRNV 7X150	84,00	136
4150177150	OPAK DÜZ UÇ TRNV 7X150 ELTA	68,75	197
4150178150	OPAK DÜZ UÇ TRNV 8X150 ELTA	74,50	197
4300178175	OPAK DÜZ UÇ TRNV 8X175	101,75	136
4150178175	OPAK DÜZ UÇ TRNV 8X175 ELTA	83,50	197
4300179200	OPAK DÜZ UÇ TRNV 9X200	134,50	136
4150008106	OPAK DÜZ&YLD UÇ TRNV SET6 ELTA	304,25	197
4300008107	OPAK DÜZ&YLD UÇ TRNV SET7	384,25	136
4150008107	OPAK DÜZ&YLD UÇ TRNV SET7 ELTA	364,50	197
3225132160	OPAK EĞRİ UÇ KRGB 160	264,25	107
3225132180	OPAK EĞRİ UÇ KRGB 180	298,75	107
3225132200	OPAK EĞRİ UÇ KRGB 200	319,00	107

KOD	ÜRÜN	FİYAT	SAYFA
3020122160	OPAK KMB PNS 160	224,75	105
3021121160	OPAK KMB PNS 160 ELTA	171,75	196
3020122180	OPAK KMB PNS 180	255,00	105
3021121180	OPAK KMB PNS 180 ELTA	210,25	196
3020122200	OPAK KMB PNS 200	287,75	105
3021121200	OPAK KMB PNS 200 ELTA	256,25	196
3020002003	OPAK PNS 160 SET3	756,50	107
4325180360	OPAK PZ UÇ TRNV 3X60	44,50	136
4325184580	OPAK PZ UÇ TRNV 4,5X80	64,00	136
4325186100	OPAK PZ UÇ TRNV 6X100	77,00	136
4325188150	OPAK PZ UÇ TRNV 8X150	146,00	136
4320180360	OPAK YLD UÇ TRNV 3X60	40,75	136
4170180360	OPAK YLD UÇ TRNV 3X60 ELTA	34,25	197
4320184580	OPAK YLD UÇ TRNV 4,5X80	58,00	136
4170184580	OPAK YLD UÇ TRNV 4,5X80 ELTA	46,50	197
4320186100	OPAK YLD UÇ TRNV 6X100	70,25	136
4170186100	OPAK YLD UÇ TRNV 6X100 ELTA	55,75	197
4320188150	OPAK YLD UÇ TRNV 8X150	133,00	136
4170188150	OPAK YLD UÇ TRNV 8X150 ELTA	105,25	197
3700162140	OPAK YNKS 140	233,75	108
3701161140	OPAK YNKS 140 ELTA	163,25	196
3700162160	OPAK YNKS 160	281,50	108
3701161160	OPAK YNKS 160 ELTA	191,75	196
3700162180	OPAK YNKS 180	328,25	108
4565170135	OTO KNT KLM 135	127,00	131
8705006113	OTO TİP HOB SET13	1.373,00	40
8010316001	PANO	4.483,50	210
8011316001	PANO ELTA	3.710,50	200
0676050042	PLS BORU KSM MKS 42	1.189,75	179
0676050063	PLS BORU KSM MKS 63	2.087,25	179
0676550042	PLS BORU KSM MKS YP BÇK 42	615,75	204
0676550063	PLS BORU KSM MKS YP BÇK 63	1.143,50	204
5850250030	PLS ÇKÇ 30	199,00	158
5850250040	PLS ÇKÇ 40	242,25	158
5850250050	PLS ÇKÇ 50	307,00	158
5850250130	PLS ÇKÇ YP BAŞLIK 30	45,00	203
5850250140	PLS ÇKÇ YP BAŞLIK 40	64,00	203
5850250150	PLS ÇKÇ YP BAŞLIK 50	91,75	203
0588150003	PLS ŞRT MT3	112,75	163
5884260003	PLS ŞRT MT3 ELTA	47,00	199
0588150005	PLS ŞRT MT5	135,25	163
5884260005	PLS ŞRT MT5 ELTA	67,75	199
3020001002	PNS&KNT KLM SET2	284,75	107
6195260260	PRÇN TBNC	447,00	165
6865281050	PROF BORU KSC	1.904,75	179
6865280150	PROF BORU KSC YP BÇK	142,75	204
4880211001	PZ1 BİTS UÇ (100)	34,50	145
4880211501	PZ1 BİTS UÇ (150)	49,50	145
4825210001	PZ1 BİTS UÇ (25)	10,00	145
4825210011	PZ1 BİTS UÇ (50)	17,50	145
4880210701	PZ1 BİTS UÇ (75)	22,75	145
4825000001	PZ1 BİTS UÇ TK10 (25)	100,00	145
4880211002	PZ2 BİTS UÇ (100)	34,50	145
4880211502	PZ2 BİTS UÇ (150)	49,50	145
4825210002	PZ2 BİTS UÇ (25)	10,00	145
4825210012	PZ2 BİTS UÇ (50)	17,50	145
4880210702	PZ2 BİTS UÇ (75)	22,75	145
4825000002	PZ2 BİTS UÇ TK10 (25)	100,00	145
4880211003	PZ3 BİTS UÇ (100)	34,50	145
4880211503	PZ3 BİTS UÇ (150)	49,50	145
4825210003	PZ3 BİTS UÇ (25)	10,00	145
4825210013	PZ3 BİTS UÇ (50)	17,50	145
4880210703	PZ3 BİTS UÇ (75)	22,75	145
4825000003	PZ3 BİTS UÇ TK10 (25)	100,00	145
7126290018	RTL ÇEK 18	696,50	187
7126290025	RTL ÇEK 25	954,75	187
7126290029	RTL ÇEK 29	1.270,00	187

KOD	ÜRÜN	FİYAT	SAYFA	KOD	ÜRÜN	FİYAT	SAYFA
7126290040	RTL ÇEK 40	1.792,75	187	0588050100	SU TRZ 100CM	631,00	164
7126290045	RTL ÇEK 45	2.263,50	187	0588050120	SU TRZ 120CM	746,50	164
0590150020	SENTİL 0,05-1	89,50	165	0588050150	SU TRZ 150CM	860,25	164
0590250020	SENTİL 2-35/1000 SAE	139,75	165	0588050200	SU TRZ 200CM	1.201,75	164
0639050125	SGM ÇMBR 125	438,25	169	0588050040	SU TRZ 40CM	405,25	164
0639050175	SGM ÇMBR 175	836,25	169	0588050050	SU TRZ 50CM	439,50	164
3335001004	SGM PNS SET4	1.121,00	110	0588050060	SU TRZ 60CM	477,75	164
14000004136	SIRT BTKÇ	935,25	42	0588050070	SU TRZ 70CM	513,00	164
3425120220	SKŞTİP HRTM KLPC PNS 235	481,00	112	0588050080	SU TRZ 80CM	554,25	164
2510110250	SPCL AYR PNS 250	430,50	103	6815270200	TEL KSM MKS 200	178,25	177
6220261000	SPRL MIKN 1000GR	298,00	165	8410336103	TKÇ GÖZ3 300	509,25	37
6220260500	SPRL MIKN 500GR	281,25	165	8410336203	TKÇ GÖZ3 420	608,75	37
8501346001	SRVMASA	9.104,00	33	8420336105	TKÇ GÖZ5 300	896,50	37
8500346001	SRVMASA P	12.024,25	32	8420336205	TKÇ GÖZ5 420	928,25	37
2505110250	STD AYR PNS 250	430,50	103	8420005046	TKÇ GÖZ5 420 ELKT SET45	6.177,50	38
6855280330	STD BORU KSC	355,00	179	8420005063	TKÇ GÖZ5 420 MKNK SET62	5.410,50	38
7010291210	STD ÇEK 2KOL 12X10	934,25	183	8420005028	TKÇ GÖZ5 420 TSTÇ SET28	5.329,00	38
7010291615	STD ÇEK 2KOL 16X15	1.592,25	183	8420336305	TKÇ GÖZ5 520	1.078,75	37
7010292015	STD ÇEK 2KOL 20X15	1.741,75	183	8420336405	TKÇ GÖZ5 600	1.136,75	37
7010292520	STD ÇEK 2KOL 25X20	3.008,25	183	8440331016	TKÇ PLS 16"	267,50	40
7010293520	STD ÇEK 2KOL 35X20	3.653,75	183	8440331019	TKÇ PLS 19"	374,50	40
7010295220	STD ÇEK 2KOL 52X20	5.370,75	183	8440331022	TKÇ PLS 22"	613,50	40
7010290810	STD ÇEK 2KOL 8X10	873,50	183	8440001023	TKÇ PLS ELKT SET23 19"	3.025,75	126
7020293720	STD ÇEK 3KOL 37X20	6.742,25	183	8445331028	TKÇ PLS TKR 28"	1.478,75	40
7020295220	STD ÇEK 3KOL 52X20	9.294,50	183	8160326001	TKD	6.073,50	29
7010291633	STD ÇEK YP BĞP 16X15-20X15	137,50	205	8243001030	TKD 1.ÇKM SET30 ECO	2.144,00	23
7010292533	STD ÇEK YP BĞP 25-35-37-52X20	240,75	205	8242001030	TKD 1.ÇKM SET30 GRJ	2.280,25	16
7010290833	STD ÇEK YP BĞP 8X10-12X10	79,75	205	8241001030	TKD 1.ÇKM SET30 PROMOB	2.280,25	12
7010291622	STD ÇEK YP KOL 16X15-20X15	274,50	205	8244001030	TKD 1.ÇKM SET30 TRND	2.144,00	25
7010292522	STD ÇEK YP KOL 25-35-37-52X20	481,00	205	8245001042	TKD 1.ÇKM SET42 PRM	4.527,50	8
7010290822	STD ÇEK YP KOL 8X10-12X10	157,75	205	8235001072	TKD 1.ÇKM SET69 PART	5.117,50	20
7010291644	STD ÇEK YP MİL 16X15-20X15	275,50	205	8235002031	TKD 2.ÇKM SET31 PART	2.272,25	21
7010292544	STD ÇEK YP MİL 25X20	474,00	205	8243002052	TKD 2.ÇKM SET49 ECO	3.248,50	23
7010293544	STD ÇEK YP MİL 35X20-37X20	617,75	205	8244002052	TKD 2.ÇKM SET49 TRND	3.248,50	25
7010295244	STD ÇEK YP MİL 52X20	617,75	205	8242002072	TKD 2.ÇKM SET69 GRJ	4.544,00	16
7010290844	STD ÇEK YP MİL 8X10-12X10	144,25	205	8241002072	TKD 2.ÇKM SET69 PROMOB	4.544,00	12
7010292033	STD ÇEK YP UZP 200	209,75	205	8245002094	TKD 2.ÇKM SET91 PRM	5.017,00	8
7010293033	STD ÇEK YP UZP 300	365,00	205	8242003010	TKD 3.ÇKM SET10 GRJ	3.112,75	17
7010294033	STD ÇEK YP UZP 400	540,00	205	8243003013	TKD 3.ÇKM SET13 ECO	2.289,25	23
2100100010	STİLSON BORU ANH 10"	498,50	101	8244003013	TKD 3.ÇKM SET13 TRND	2.289,25	25
2100100012	STİLSON BORU ANH 12"	561,00	101	8245003014	TKD 3.ÇKM SET14 PRM	2.340,75	8
2100100014	STİLSON BORU ANH 14"	688,50	101	8235003017	TKD 3.ÇKM SET17 PART	2.212,00	21
2100100018	STİLSON BORU ANH 18"	874,00	101	8241003051	TKD 3.ÇKM SET51 PROMOB	2.157,00	12
2100100024	STİLSON BORU ANH 24"	1.408,00	101	8242004018	TKD 4.ÇKM SET18 GRJ	1.753,25	17
2100100008	STİLSON BORU ANH 8"	414,50	101	8241004027	TKD 4.ÇKM SET27 PROMOB	3.757,25	13
2100100210	STİLSON BORU ANH YP BĞP 10"	286,50	202	8245004043	TKD 4.ÇKM SET43 PRM	2.670,00	9
2100100212	STİLSON BORU ANH YP BĞP 12"	313,75	202	8241005010	TKD 5.ÇKM SET10 PROMOB	3.112,75	13
2100100214	STİLSON BORU ANH YP BĞP 14"	378,75	202	8242005011	TKD 5.ÇKM SET11 GRJ	1.390,50	17
2100100218	STİLSON BORU ANH YP BĞP 18"	434,25	202	8245005043	TKD 5.ÇKM SET43 PRM	2.879,50	9
2100100224	STİLSON BORU ANH YP BĞP 24"	649,00	202	8241006018	TKD 6.ÇKM SET18 PROMOB	1.753,25	13
2100100208	STİLSON BORU ANH YP BĞP 8"	193,00	202	8245006009	TKD 6.ÇKM SET9 PRM	6.335,25	9
2100100110	STİLSON BORU ANH YP ÇENE 10"	186,50	202	8247321007	TKD AŞŞAP ÜST TBL KRMZ ANT WB	15.020,75	27
2100100112	STİLSON BORU ANH YP ÇENE 12"	208,00	202	8246321007	TKD AŞŞAP ÜST TBL KRMZ ANT XXL	16.006,00	26
2100100114	STİLSON BORU ANH YP ÇENE 14"	250,75	202	8243321003	TKD ÇKM3 KRMZ GRİ ECO	6.367,50	22
2100100118	STİLSON BORU ANH YP ÇENE 18"	337,25	202	8243323005	TKD ÇKM5 GRİ GRİ ECO	6.367,50	22
2100100124	STİLSON BORU ANH YP ÇENE 24"	483,00	202	8242323005	TKD ÇKM5 GRİ GRİ GRJ	9.593,75	15
2100100108	STİLSON BORU ANH YP ÇENE 8"	126,00	202	8241323005	TKD ÇKM5 GRİ GRİ PROMOB	10.737,00	11
2100100310	STİLSON BORU ANH YP SMN 10"	103,25	202	8241321005	TKD ÇKM5 GRİ KRMZ PROMOB	10.737,00	11
2100100312	STİLSON BORU ANH YP SMN 12"	107,75	202	8241322005	TKD ÇKM5 GRİ MAVİ PROMOB	10.737,00	11
2100100314	STİLSON BORU ANH YP SMN 14"	120,25	202	8243321005	TKD ÇKM5 KRMZ GRİ ECO	6.367,50	22
2100100318	STİLSON BORU ANH YP SMN 18"	166,00	202	8242321005	TKD ÇKM5 KRMZ GRİ GRJ	9.593,75	15
2100100324	STİLSON BORU ANH YP SMN 24"	181,50	202	8235326005	TKD ÇKM5 KRMZ PART	8.728,50	19
2100100308	STİLSON BORU ANH YP SMN 8"	93,50	202	8235006121	TKD ÇKM5 KRMZ SET118 PART	18.330,25	19
7070292013	STİP ÇEK 2KOL 20X13	964,00	185	8243001096	TKD ÇKM5 KRMZ SET93 ECO	14.049,25	22
7080292013	STİP ÇEK 3KOL 20X13	1.243,25	185	8244005096	TKD ÇKM5 KRMZ SET93 TRND	14.074,75	24
7070292022	STİP ÇEK YP KOL 20X13	172,75	205	8244321005	TKD ÇKM5 KRMZ SYH TRND	6.393,00	24
7070292044	STİP ÇEK YP MİL 20X13	241,00	205	8243322005	TKD ÇKM5 MAVİ GRİ ECO	6.367,50	22

KOD	ÜRÜN	FİYAT	SAYFA	KOD	ÜRÜN	FİYAT	SAYFA
8242322005	TKD ÇKM5 MAVİ GRİ GRJ	9.593,75	15	4885210727	TORX BITS UÇ T27 (75)	24,25	145
8235325005	TKD ÇKM5 MAVİ PART	8.728,50	19	4830000027	TORX BITS UÇ T27 TK10 (25)	137,50	145
8235327005	TKD ÇKM5 SYH PART	8.728,50	19	4885211030	TORX BITS UÇ T30 (100)	35,00	145
8245321005	TKD ÇKM5 SYH PRM	10.384,50	7	4885211530	TORX BITS UÇ T30 (150)	50,25	145
8242323006	TKD ÇKM6 GRİ GRİ GRJ	11.292,50	15	4830210030	TORX BITS UÇ T30 (25)	13,75	145
8241323006	TKD ÇKM6 GRİ GRİ PROMOB	11.602,25	11	4830210130	TORX BITS UÇ T30 (50)	17,50	145
8241321006	TKD ÇKM6 GRİ KRMZ PROMOB	11.602,25	11	4885210730	TORX BITS UÇ T30 (75)	24,25	145
8241322006	TKD ÇKM6 GRİ MAVİ PROMOB	11.602,25	11	4830000030	TORX BITS UÇ T30 TK10 (25)	137,50	145
8242321006	TKD ÇKM6 KRMZ GRİ GRJ	11.292,50	15	4885211040	TORX BITS UÇ T40 (100)	35,00	145
8242322006	TKD ÇKM6 MAVİ GRİ GRJ	11.292,50	15	4885211540	TORX BITS UÇ T40 (150)	50,25	145
8243323007	TKD ÇKM7 GRİ GRİ ECO	8.536,50	22	4830210040	TORX BITS UÇ T40 (25)	13,75	145
8242323007	TKD ÇKM7 GRİ GRİ GRJ	13.194,00	15	4830210140	TORX BITS UÇ T40 (50)	17,50	145
8241323007	TKD ÇKM7 GRİ GRİ PROMOB	13.711,00	11	4885210740	TORX BITS UÇ T40 (75)	24,25	145
8241321007	TKD ÇKM7 GRİ KRMZ PROMOB	13.711,00	11	4830000040	TORX BITS UÇ T40 TK10 (25)	137,50	145
8241322007	TKD ÇKM7 GRİ MAVİ PROMOB	13.711,00	11	0380020008	TORX KMB ANH 08	95,75	59
8243321007	TKD ÇKM7 KRMZ GRİ ECO	8.536,50	22	0380020009	TORX KMB ANH 09	97,25	59
8242321007	TKD ÇKM7 KRMZ GRİ GRJ	13.194,00	15	0380020010	TORX KMB ANH 10	107,75	59
8242001142	TKD ÇKM7 KRMZ SET139 GRJ	26.274,75	15	0380020011	TORX KMB ANH 11	113,75	59
8243007096	TKD ÇKM7 KRMZ SET93 ECO	16.218,25	22	0380020012	TORX KMB ANH 12	116,75	59
8244007096	TKD ÇKM7 KRMZ SET93 TRND	14.338,25	24	0380020013	TORX KMB ANH 13	128,00	59
8244321007	TKD ÇKM7 KRMZ SYH TRND	6.656,50	24	0380020014	TORX KMB ANH 14	141,75	59
8243322007	TKD ÇKM7 MAVİ GRİ ECO	8.536,50	22	0380020015	TORX KMB ANH 15	150,00	59
8242322007	TKD ÇKM7 MAVİ GRİ GRJ	13.194,00	15	0380020017	TORX KMB ANH 17	162,75	59
8245007096	TKD ÇKM7 SET243 PRM	37.213,50	7	0380020018	TORX KMB ANH 18	176,75	59
8245321007	TKD ÇKM7 SYH PRM	13.443,50	7	0380020019	TORX KMB ANH 19	191,25	59
8242323008	TKD ÇKM8 GRİ GRİ GRJ	14.484,00	15	0380020022	TORX KMB ANH 22	257,25	59
8241323008	TKD ÇKM8 GRİ GRİ PROMOB	14.615,25	11	038002112	TORX KMB ANH TK12	1.739,00	59
8241321008	TKD ÇKM8 GRİ KRMZ PROMOB	14.615,25	11	038002108	TORX KMB ANH TK8	1.013,25	59
8241322008	TKD ÇKM8 GRİ MAVİ PROMOB	14.615,25	11	4775180010	TORX UÇ TRNV T10	57,75	141
8242321008	TKD ÇKM8 KRMZ GRİ GRJ	14.484,00	15	4775180015	TORX UÇ TRNV T15	57,75	141
8242008142	TKD ÇKM8 KRMZ SET139 GRJ	27.564,75	15	4775180020	TORX UÇ TRNV T20	64,00	141
8241001209	TKD ÇKM8 KRMZ SET206 PROMOB	32.219,75	11	4775180025	TORX UÇ TRNV T25	74,25	141
8242322008	TKD ÇKM8 MAVİ GRİ GRJ	14.484,00	15	4775180027	TORX UÇ TRNV T27	81,75	141
8210326001	TKD VGN	6.734,25	28	4775180030	TORX UÇ TRNV T30	86,75	141
8015316001	TKR 3GEN PANO	2.336,25	209	4775180040	TORX UÇ TRNV T40	108,00	141
6860280635	TLSK BORU KSC	754,75	179	4775180045	TORX UÇ TRNV T45	122,00	141
6820270200	TNK MKS 200	291,75	176	4775008107	TORX UÇ TRNV TK7	530,25	141
6820270250	TNK MKS 250	372,75	176	5520230125	TRN KSK 130	115,25	156
6820270300	TNK MKS 300	406,25	176	5520230150	TRN KSK 150	137,25	156
6821270250	TNK MKS YAY 250	404,75	176	3860260180	TSTR ÇPRZ	373,25	114
6821270300	TNK MKS YAY 300	442,75	176	5891260830	TSTR KOL 300 ELTA	168,00	199
4910220010	TORX ALLEN ANH T10	49,50	149	0589050830	TSTR KOL 30CM	423,75	164
4910220015	TORX ALLEN ANH T15	51,00	149	5800251000	TSVY ÇKÇ 1000GR	307,50	158
4910220020	TORX ALLEN ANH T20	53,50	149	5800250100	TSVY ÇKÇ 100GR	139,25	158
4910220025	TORX ALLEN ANH T25	53,50	149	5800251500	TSVY ÇKÇ 1500GR	403,75	158
4910220027	TORX ALLEN ANH T27	53,50	149	5800252000	TSVY ÇKÇ 2000GR	496,50	158
4910220030	TORX ALLEN ANH T30	57,25	149	5800250200	TSVY ÇKÇ 200GR	151,75	158
4910220040	TORX ALLEN ANH T40	61,00	149	5800250300	TSVY ÇKÇ 300GR	183,75	158
4910220045	TORX ALLEN ANH T45	74,75	149	5800250500	TSVY ÇKÇ 500GR	212,75	158
4910220050	TORX ALLEN ANH T50	85,00	149	5800250010	TSVY ÇKÇ YP SAP&KAMA 1000GR	75,50	203
4910220055	TORX ALLEN ANH T55	118,00	149	5800250001	TSVY ÇKÇ YP SAP&KAMA 100GR	46,25	203
4910220060	TORX ALLEN ANH T60	162,50	149	5800250015	TSVY ÇKÇ YP SAP&KAMA 1500GR	85,00	203
4910220060	TORX ALLEN ANH T60	162,50	149	5800250020	TSVY ÇKÇ YP SAP&KAMA 2000GR	91,50	203
4910220070	TORX ALLEN ANH T70	162,50	149	5800250002	TSVY ÇKÇ YP SAP&KAMA 200GR	46,50	203
4910220080	TORX ALLEN ANH T80	162,50	149	5800250003	TSVY ÇKÇ YP SAP&KAMA 300GR	52,00	203
4910220090	TORX ALLEN ANH T90	162,50	149	5800250005	TSVY ÇKÇ YP SAP&KAMA 500GR	58,25	203
4910007108	TORX ALLEN ANH TK8	428,75	149	5510230125	TSVY DÜZ KSK 125	102,75	156
4885211025	TORX BITS UÇ T25 (100)	35,00	145	5510230150	TSVY DÜZ KSK 150	128,25	156
4885211525	TORX BITS UÇ T25 (150)	50,25	145	4920220030	TTİP 6KŞ ALLEN ANH 03	69,00	151
4830210025	TORX BITS UÇ T25 (25)	13,75	145	4920220040	TTİP 6KŞ ALLEN ANH 04	77,50	151
4830210125	TORX BITS UÇ T25 (50)	17,50	145	4920220050	TTİP 6KŞ ALLEN ANH 05	82,75	151
4885210725	TORX BITS UÇ T25 (75)	24,25	145	4920220060	TTİP 6KŞ ALLEN ANH 06	94,50	151
4830000025	TORX BITS UÇ T25 TK10 (25)	137,50	145	4920220070	TTİP 6KŞ ALLEN ANH 07	99,25	151
4885211027	TORX BITS UÇ T27 (100)	35,00	145	4920220080	TTİP 6KŞ ALLEN ANH 08	116,50	151
4885211527	TORX BITS UÇ T27 (150)	50,25	145	4920220100	TTİP 6KŞ ALLEN ANH 10	176,50	151
4830210027	TORX BITS UÇ T27 (25)	13,75	145	4920220025	TTİP 6KŞ ALLEN ANH 2,5	67,75	151
4830210127	TORX BITS UÇ T27 (50)	17,50	145	4920008108	TTİP 6KŞ ALLEN ANH TK8	783,75	151

KOD	ÜRÜN	FİYAT	SAYFA	KOD	ÜRÜN	FİYAT	SAYFA
4921220030	TTİP 6KŞ YVRL BAŞL ALLEN ANH 03	89,25	151	482000002	YLD BİTS UÇ TK10 PH2 (25)	92,50	144
4921220040	TTİP 6KŞ YVRL BAŞL ALLEN ANH 04	100,00	151	482000003	YLD BİTS UÇ TK10 PH3 (25)	92,50	144
4921220050	TTİP 6KŞ YVRL BAŞL ALLEN ANH 05	107,25	151	0750050100	YLD ÇAK ANH 100	5.138,25	64
4921220060	TTİP 6KŞ YVRL BAŞL ALLEN ANH 06	122,75	151	0750050105	YLD ÇAK ANH 105	5.304,00	64
4921220070	TTİP 6KŞ YVRL BAŞL ALLEN ANH 07	128,50	151	0750050110	YLD ÇAK ANH 110	5.670,00	64
4921220080	TTİP 6KŞ YVRL BAŞL ALLEN ANH 08	138,25	151	0750050115	YLD ÇAK ANH 115	6.355,75	64
4921220100	TTİP 6KŞ YVRL BAŞL ALLEN ANH 10	229,25	151	0750050120	YLD ÇAK ANH 120	8.735,25	64
4921220025	TTİP 6KŞ YVRL BAŞL ALLEN ANH 2,5	88,00	151	0750050125	YLD ÇAK ANH 125	-	64
4921008108	TTİP 6KŞ YVRL BAŞL ALLEN ANH TK8	1.003,25	151	0750050130	YLD ÇAK ANH 130	-	64
4922220030	TTİP ALLEN ANH 03 ELTA	56,25	198	0750050135	YLD ÇAK ANH 135	-	64
4922220040	TTİP ALLEN ANH 04 ELTA	57,00	198	0750050140	YLD ÇAK ANH 140	-	64
4922220050	TTİP ALLEN ANH 05 ELTA	64,50	198	0750050145	YLD ÇAK ANH 145	-	64
4922220060	TTİP ALLEN ANH 06 ELTA	70,75	198	0750050150	YLD ÇAK ANH 150	-	64
4922220070	TTİP ALLEN ANH 07 ELTA	73,25	198	0750050155	YLD ÇAK ANH 155	-	64
4922220080	TTİP ALLEN ANH 08 ELTA	88,25	198	0750050160	YLD ÇAK ANH 160	-	64
4922220100	TTİP ALLEN ANH 10 ELTA	154,00	198	0750050165	YLD ÇAK ANH 165	-	64
4922220025	TTİP ALLEN ANH 2,5 ELTA	56,00	198	0750050170	YLD ÇAK ANH 170	-	64
4922008108	TTİP ALLEN ANH TK8 ELTA	620,00	198	0750050180	YLD ÇAK ANH 180	-	64
4765190040	TTİP LKM UÇ TRNV 04	102,25	140	0750050024	YLD ÇAK ANH 24	240,00	64
4765190050	TTİP LKM UÇ TRNV 05	102,25	140	0750050027	YLD ÇAK ANH 27	286,50	64
4765190060	TTİP LKM UÇ TRNV 06	102,25	140	0750050030	YLD ÇAK ANH 30	341,75	64
4765190070	TTİP LKM UÇ TRNV 07	109,00	140	0750050032	YLD ÇAK ANH 32	392,75	64
4765190080	TTİP LKM UÇ TRNV 08	109,00	140	0750050036	YLD ÇAK ANH 36	444,50	64
4765190090	TTİP LKM UÇ TRNV 09	121,00	140	0750050038	YLD ÇAK ANH 38	532,25	64
4765190100	TTİP LKM UÇ TRNV 10	121,00	140	0750050041	YLD ÇAK ANH 41	581,00	64
4765190110	TTİP LKM UÇ TRNV 11	133,75	140	0750050042	YLD ÇAK ANH 42	664,25	64
4765190120	TTİP LKM UÇ TRNV 12	138,00	140	0750050046	YLD ÇAK ANH 46	694,75	64
4765190130	TTİP LKM UÇ TRNV 13	144,50	140	0750050047	YLD ÇAK ANH 47	766,50	64
4765190140	TTİP LKM UÇ TRNV 14	168,00	140	0750050050	YLD ÇAK ANH 50	820,25	64
4765190055	TTİP LKM UÇ TRNV 5,5	102,25	140	0750050055	YLD ÇAK ANH 55	1.153,75	64
4795190010	TTİP MNY BİTS TUTC TRNV 6,3X130	158,75	143	0750050060	YLD ÇAK ANH 60	1.251,75	64
4909220010	TTİP TORX ALLEN ANH T10	128,00	150	0750050065	YLD ÇAK ANH 65	1.636,50	64
4909220015	TTİP TORX ALLEN ANH T15	130,75	150	0750050070	YLD ÇAK ANH 70	1.873,50	64
4909220020	TTİP TORX ALLEN ANH T20	131,75	150	0750050075	YLD ÇAK ANH 75	2.005,25	64
4909220025	TTİP TORX ALLEN ANH T25	134,75	150	0750050080	YLD ÇAK ANH 80	2.848,25	64
4909220027	TTİP TORX ALLEN ANH T27	149,75	150	0750050085	YLD ÇAK ANH 85	3.204,50	64
4909220030	TTİP TORX ALLEN ANH T30	154,00	150	0750050090	YLD ÇAK ANH 90	3.941,75	64
4909220040	TTİP TORX ALLEN ANH T40	159,75	150	0750050095	YLD ÇAK ANH 95	4.444,75	64
4909220009	TTİP TORX ALLEN ANH T9	125,50	150	3705165160	YNKSK İNCE UÇ 160	366,25	110
4909008108	TTİP TORX ALLEN ANH TK8	1.114,25	150	0530040810	YRM AY YLD ANH 0810	85,00	63
6401250600	USTA KSR 400GR	405,00	159	0531041214	YRM AY YLD ANH 1/2X9/16 SAE	143,00	63
2500110250	ÜNV AYR PNS 250	430,50	103	0530041011	YRM AY YLD ANH 1011	99,75	63
7090292222	ÜNV ÇEK 2KOL 22X22	1.071,25	185	0530041012	YRM AY YLD ANH 1012	99,75	63
7100292222	ÜNV ÇEK 3KOL 22X22	1.404,25	185	0530041113	YRM AY YLD ANH 1113	99,75	63
7090292322	ÜNV ÇEK YP KOL 22X22	192,00	205	0530041315	YRM AY YLD ANH 1315	118,75	63
7090292244	ÜNV ÇEK YP MİL 22X22	253,75	205	0530041317	YRM AY YLD ANH 1317	118,75	63
2400110160	ÜNV FORT PNS 160	258,50	102	0530041417	YRM AY YLD ANH 1417	118,75	63
2400110240	ÜNV FORT PNS 240	361,50	102	0530041517	YRM AY YLD ANH 1517	118,75	63
2400110315	ÜNV FORT PNS 315	592,00	102	0530041922	YRM AY YLD ANH 1922	154,50	63
4790266360	ÜNV MNY BİTS ADP 6,3X60	71,50	142	0531041922	YRM AY YLD ANH 3/4X7/8 SAE	185,50	63
6370260100	YAĞ FLT SÖKM 100	209,75	167	0531040911	YRM AY YLD ANH 3/8X7/16 SAE	119,75	63
4870211001	YLD BİTS UÇ PH1 (100)	34,25	144	0531040809	YRM AY YLD ANH 5/16X3/8 SAE	101,75	63
4870211501	YLD BİTS UÇ PH1 (150)	48,25	144	0531041112	YRM AY YLD ANH 7/16X1/2 SAE	123,00	63
4820210001	YLD BİTS UÇ PH1 (25)	9,25	144	0531041417	YRM AY YLD ANH 9/16X11/16 SAE	142,50	63
4820210011	YLD BİTS UÇ PH1 (50)	16,50	144	0531041416	YRM AY YLD ANH 9/16X5/8 SAE	147,25	63
4870210701	YLD BİTS UÇ PH1 (75)	22,25	144	0637450140	ZNCR YAĞ FLT SÖKM 60-140	443,00	168
4870211002	YLD BİTS UÇ PH2 (100)	34,25	144				
4870211502	YLD BİTS UÇ PH2 (150)	48,25	144				
4820210002	YLD BİTS UÇ PH2 (25)	9,25	144				
4820210012	YLD BİTS UÇ PH2 (50)	16,50	144				
4870210702	YLD BİTS UÇ PH2 (75)	22,25	144				
4870211003	YLD BİTS UÇ PH3 (100)	34,25	144				
4870211503	YLD BİTS UÇ PH3 (150)	48,25	144				
4820210003	YLD BİTS UÇ PH3 (25)	9,25	144				
4820210013	YLD BİTS UÇ PH3 (50)	16,50	144				
4870210703	YLD BİTS UÇ PH3 (75)	22,25	144				
4820000001	YLD BİTS UÇ TK10 PH1 (25)	92,50	144				







## İŞIKKENT FABRİKASI



58.280 M<sup>2</sup> Açık 24.320 M<sup>2</sup> Kapalı Alan

## TURGUTLU FABRİKASI



40.415 M<sup>2</sup> Açık 13.120 M<sup>2</sup> Kapalı Alan

## SÜTÇÜLER FABRİKASI



41.225 M<sup>2</sup> Açık 14.050 M<sup>2</sup> Kapalı Alan

## ALİAĞA FABRİKASI



Aliğa Fabrikası yakında hizmetinizde...

50.000 M<sup>2</sup> Arsa



İzeltaş El Aletleri Sanayi ve Ticaret A.Ş.

Kemalpaşa Cad. No: 303  
İşikkent / İzmir / TÜRKİYE

**Sipariş Telefon**  
*Phone for Orders*

**DT:** +90 232 472 13 92  
**T:** +90 232 472 13 75  
**F:** +90 232 472 13 78

**Adana Bölge Müdürlüğü**  
*Adana Office*

+90 533 495 53 09

**Ankara Bölge Müdürlüğü**  
*Ankara Office*

+90 533 603 47 29

**İstanbul Bölge Müdürlüğü**  
*İstanbul Office*

+90 533 603 41 81  
+90 535 461 54 87



izeltas\_



/izeltaselaetleri



İZELTAŞ



izeltas A.S.

[www.izeltas.com.tr](http://www.izeltas.com.tr)